

“ Il bambino che ha sentito forte
l’amore, la gioia ed entusiasmo nel lavoro,
ci fa sperare che l’umanità
possa svilupparsi in un senso nuovo ”

SCUOLA BUS®

Proposte per la scuola 2022-2023



“L’educazione assume oggi, nel particolare momento sociale che attraversiamo, un’importanza veramente illimitata. E questa accentuazione del suo valore pratico si può esprimere con una sola frase: l’educazione è l’arma della pace. Occorre organizzare la pace, preparandola scientificamente attraverso l’educazione.”

(Maria Montessori, Educate per la pace, in Educazione e Pace)

Sommario



1

Laboratorio di immagine

| | |
|--------------------|----|
| Carte e cartoncini | 2 |
| Portacarte | 36 |
| Fustelle | 39 |



45

Laboratorio di pittura

| | |
|--------------------------|-----|
| Colore | 46 |
| Strumenti e accessori | 70 |
| Pittura per i più grandi | 104 |



117

Manipolazione e scultura

| | |
|------------------------------|-----|
| Manipolazione e modellaggio | 118 |
| Materiali e stampi da colata | 127 |
| Scultura per i più grandi | 133 |



138

Materiale creativo

| | |
|------------------------|-----|
| Supporti da decorare | 139 |
| Materiali per decorare | 167 |
| Tecniche artistiche | 212 |
| Confezioni regalo | 243 |
| Festività e ricorrenze | 256 |



263

Cancelleria e consumo

| | |
|-------------------------------|-----|
| Cancelleria | 264 |
| Accessori segreteria | 291 |
| Disegno tecnico/comunicazione | 305 |
| Imballaggio | 324 |
| Igiene e Pronto Soccorso | 332 |



327

Prime esperienze di gioco

| | |
|-------------------------|-----|
| Prima infanzia | 328 |
| Esplorazioni sensoriali | 342 |
| Crescere Giocando | 373 |
| Imparare giocando | 388 |



443

Logica, matematica e sperimentazione

| | |
|----------------------------|-----|
| Ambito logico e matematico | 454 |
| Ambito tecnico-scientifico | 473 |
| Programma educativo ROLF | 490 |



492

Gioco simbolico e di immaginazione

| | |
|-----------------------------|-----|
| Imitazione | 493 |
| Drammatizzazione e finzione | 506 |
| Educazione ambientale | 508 |
| Strumenti musicali | 519 |
| Libri per bambini | 524 |



531

Movimento e psicomotricità

| | |
|---------------------------------|-----|
| Morbido | 533 |
| Materassi e tappeti | 549 |
| Attrezzi ginnici/psicomotricità | 567 |
| Giochi ricreativi | 696 |
| Dondoli, carriole, tricicli | 613 |



618

Arredo

| | |
|------------------------|-----|
| Accoglienza | 620 |
| Spogliatoi | 629 |
| Aula pranzo | 634 |
| Arredi per adulti | 654 |
| Aula riposo | 657 |
| Angolo gioco | 679 |
| Protezione e sicurezza | 687 |



695

Prodotti per la prevenzione

| | |
|-------------------------------|-----|
| Piantane per gel igienizzante | 696 |
| Segnaletica COVID | 697 |
| Tappeto antibatterico | 698 |
| Barriere protettive | 699 |

Legenda



LxPxA

Dimensioni



Indica l'età di utilizzo consigliata



Segnala il numero di pezzi con cui è composto il prodotto



Portata massima del prodotto



Peso del prodotto



Articolo da montare



Il prodotto contiene parti magnetiche



Puzzle



Domino



Articolo con parti sonore



Giochi di esplorazione sensoriale



Giochi di fantasia



Abbinamento e memoria



Linguaggio e alfabetizzazione



Numeri e conteggio

- Il bollino rosso posto prima del codice indica che l'articolo è in disponibile solo fino ad esaurimento scorte.

Le immagini in questo catalogo sono inserite a scopo illustrativo e possono subire modifiche e aggiornamenti.



Laboratorio di immagine

Fantasia e creatività sono i tratti distintivi di ogni bambino.

Attraverso la creatività il bambino è in grado di esprimere sé stesso, i propri sentimenti, la propria personalità. Per questo motivo è importante promuovere attività che stimolino curiosità, fantasia e immaginazione...

Nulla è meglio di un foglio di carta per sprigionare la creatività!

Proponiamo un'ampia gamma di carte e cartoncini che forniranno un eccellente supporto alla voglia di creare e di esprimersi.

2 Carte e cartoncini

36 Portacarte

39 Fustelle

43 Fustellatrice

Carta Bianca

Carta bianca per disegni.
Molto resistente. Ideale per realizzare disegni, schizzi, collage.
Utilizzabile con matite, pastelli, gessi, pennarelli ecc.

...PER SCENOGRAFIE...

Studiata appositamente per progetti e sagome di grandi dimensioni.
Robustissima, tenace, bianchissima, duttile e resistente.

...E PER FONDALI

Concepita per realizzare lavori di grandi dimensioni.
I rotoli consentono un utilizzo molto facile e pratico: basta srotolare la carta fino alla lunghezza desiderata e tagliare. Le carte per fondali sono indicate anche come sostitutivo della lavagna.

Carta per schizzi... e scenografie!

GR.42

09774 - cm.100x50 mt. (rotolo)

● 09775 - cm.120x50 mt. (rotolo)

GR.80

08159 - cm.35x20 mt. (rotolo)

09144 - cm.70x10 mt. (rotolo)

1020 - cm.70x20 mt. (rotolo)

07106 - cm.70x50 mt. (rotolo)

07107 - cm.100x10 mt. (rotolo)

07108 - cm.100x50 mt. (rotolo)

05680 - cm.150x10 mt. (rotolo)

09690 - cm.100x150 (fogli 1 kg.)

1021 - cm.100x150 (fogli 5 kg.)

1024 - cm.100x150 (20 fogli piegati)

GR.90

08023 - cm.42x50 mt. (rotolo)

GR.100

08777 - cm.100x20 mt. (rotolo)

04168 - cm.100x150 (4 fogli piegati)



Carta bianca, adesiva e rimovibile

● **871408**

album 25 fogli **ADESIVI**
cm.21x29,7 (A4)

Basta attaccare questi speciali fogli sul muro e il divertimento può avere inizio! Potete staccare i vostri capolavori e attaccarli su pareti, porte e molte altre superfici. Utilizzabile con matite, pennarelli, pastelli, ecc...



Carta bianca da disegno



06262

album 16 fogli cm.17x24 - gr.85

06263

album 32 fogli cm.17x24 - gr.85

06264

album 20 fogli cm.24x33 - gr.110

Una gamma completa di carte da disegno per consentire ai bambini di esprimere la propria creatività utilizzando matite, pennarelli, pennelli e colori, forbici, colle...



Carta per acquerello e schizzo

TALENTO è una carta per acquerello prodotta con il 100% di cellulosa, priva di acidi e di agenti sbiancanti ottici.

Nata per le tecniche umide quali acquerelli e inchiostri, ma la sua grana fine e le sue particolari caratteristiche la rendono adatta anche a tecniche secche quali matite, gessi, carboncini, pastelli, pennarelli...

CARTA PER ACQUERELLO BLOCCO 10 FOGLI GR.300

MU131294 - 210x297 mm (A4) GRANA FINE

MU131293 - 297x420 mm (A3) GRANA FINE

NOVITA'

MU131295 - 158x210 mm (A5) GRANA FINE

DEBUTTO è una carta per schizzo e disegno prodotta con il 100% di cellulosa, extra bianca, priva di acidi e di agenti sbiancanti ottici.

Prodotta con grana liscia, appositamente studiata per tecniche secche quali matite, gessi, carboncini, pastelli, pennarelli...

CARTA PER SCHIZZO BLOCCO SPIRALATO FOGLI MICROPERFORATI

MU133394

210x297 mm (A4+) 70 FOGLI GR.120 - GRANA LISCIA

MU133393

297x420 mm (A3+) 50 FOGLI GR.120 - GRANA LISCIA





Carte e cartoncini unicolore in risme



GR.80

- 12296/101 - 100 fogli A4 ● avorio
- 12299/101 - 100 fogli A4 ● giallo
- 12299/102 - 100 fogli A4 ● arancione
- 12299/103 - 100 fogli A4 ● rosso
- 12299/104 - 100 fogli A4 ● verde
- 12299/105 - 100 fogli A4 ● blu cyan
- 12299/121 - 100 fogli A4 ● nero

GR.160

- 12304/101 - 100 fogli A4 ● avorio
- 12306/101 - 100 fogli A4 ● giallo
- 12306/102 - 100 fogli A4 ● arancione
- 12306/103 - 100 fogli A4 ● rosso
- 12306/104 - 100 fogli A4 ● verde
- 12306/105 - 100 fogli A4 ● blu cyan
- 12306/120 - 100 fogli A4 ○ bianco
- 12306/121 - 100 fogli A4 ● nero

GR.200

- 12308/101 - 100 fogli A4 ● avorio
- 12310/101 - 100 fogli A4 ● giallo
- 12310/102 - 100 fogli A4 ● arancione
- 12310/103 - 100 fogli A4 ● rosso
- 12310/104 - 100 fogli A4 ● verde
- 12310/105 - 100 fogli A4 ● blu cyan
- 12310/120 - 100 fogli A4 ○ bianco
- 12310/121 - 100 fogli A4 ● nero



Assortimento 12 colori tenui e forti

GR.80 ● ● ● ● ● ● ● ● ● ● ○ ●

12506 - 12 fogli A4

GR.200 ● ● ● ● ● ● ● ● ● ● ○ ●

12507 - 12 fogli A4

Carte e cartoncini assortiti in risme



Assortimento 5 colori tenui

GR.80 ● ● ● ● ●

12296/100 - 100 fogli A4 (colori tenui)

12296/250 - 250 fogli A4 (colori tenui)

12298/250 - 250 fogli A3 (colori tenui)

GR.160 ● ● ● ● ●

12304/100 - 100 fogli A4 (colori tenui)

12305/100 - 100 fogli A3 (colori tenui)

GR.200 ● ● ● ● ●

12308/100 - 100 fogli A4 (colori tenui)

12309/100 - 100 fogli A3 (colori tenui)



Assortimento 5 colori forti

GR.80 ● ● ● ● ●

12299/100 - 100 fogli A4 (colori forti)

12299/250 - 250 fogli A4 (colori forti)

12301/250 - 250 fogli A3 (colori forti)

GR.160 ● ● ● ● ●

12306/100 - 100 fogli A4 (colori forti)

12307/100 - 100 fogli A3 (colori forti)

GR.200 ● ● ● ● ●

12310/100 - 100 fogli A4 (colori forti)

12311/100 - 100 fogli A3 (colori forti)



PACK SCUOLA cm.70x100

Assortimento 10 colori tenui e forti

GR.80 ● ● ● ● ● ● ● ● ● ●

12302/50 - 50 fogli cm.70x100

GR.120 ● ● ● ● ● ● ● ● ● ●

12303/50 - 50 fogli cm.70x100

Carta colorata

Molto resistente. Disponibile in colori opachi con retro bianco.



Rotolo cm.71x15 metri gr.90

- 05743** ● rosso
- 05744** ● verde
- 05745** ● giallo
- 05746** ● azzurro
- 05747** ● tabacco

Carta quadrettata e centimetrata



2020

album 24 fogli cm.21x29,7 gr.100
quadretto cm.0,5

1025

rotolo cm.70x20 metri gr.80
quadretto cm.1

07990

rotolo cm.100x20 metri gr.80
quadretto cm.1

1000

album 50 fogli cm.25x35 gr.100
quadretto cm.1

1005

album 50 fogli cm.35x50 gr.100
quadretto cm.1

1010

album 50 fogli cm.50x70 gr.100
quadretto cm.1

Carta spolvero

Carta giallina tenace e ruvida.



GR.90

- 06452** - cm.23x33 (blocco 50 fogli)
- 1033** - cm.35x50 (blocco 50 fogli)
- 1034** - cm.50x70 (blocco 50 fogli)
- 1035** - cm.70x100 (blocco 20 fogli)
- 1038** - cm.150x5 MT. (rotolo)
- 10734** - cm.100x5 MT. (rotolo)
- 09859** - cm.150x10 MT. (rotolo)

Carta paglia

07196

cm.27x37 (rotolo 12 fogli)

07197

cm.50x70 (rotolo 20 fogli)

Fabbricata con la paglia di grano, si riconosce per il caratteristico colore giallo e per lo spessore consistente. Supporta i collanti, è resistente e può essere decorata con matite, gessi, tempere, acquerelli...

Carta avana-Carta da pacco

GR.60

- 1027** - cm.70x5 MT. (rotolo)
- 05703** - cm.70x20 MT. (rotolo)
- 11940** - cm.100x10 MT. (rotolo)
- 11941** - cm.100x25 MT. (rotolo)

GR.80

- 1023** - cm.100x150 (20 fogli)
- 09691** - cm.100x150 (fogli, 1 KG.)
- 1022** - cm.100x150 (41 fogli, 5 KG.)
- 08778** - cm.100x50 MT. (rotolo, 4 KG.)

Pergamene

Utilizzabile anche con stampanti laser e a getto di inchiostro.



Conf. 12 fogli gr.230
(bordi irregolari)

● **05627** - cm.14,8x21

05628 - cm.21x29,7

05629 - cm.29,7x42

05630 - cm.60x84



06706

06707

Conf. 10 fogli gr.230
(cornice stampata)

06706 - cm.21x29,7

06707 - cm.29,7x42



Conf. 12 fogli gr.90 (bordi regolari)

05623 - cm.14,8x21

05624 - cm.21x29,7

05625 - cm.29,7x42

05626 - cm.42x59,4

Conf. 12 fogli gr.230 (bordi regolari)

07932 - cm.21x29,7

07933 - cm.29,7x42

07934 - cm.42x59,4



09908

Conf. 10 fogli cm.21x29,7 gr.100
in carta vegetale **trasparente**
(tipo lucidi)



09890

Conf. 10 fogli cm.21x29,7 gr.160
"Gonzaga" in finissima carta telata



06700

06701

Conf. 10 fogli cm.21x29,7 gr.120

06700 - fantasia 1

06701 - fantasia 2



06702

06703

Conf. 10 fogli cm.24x34 gr.120

06702 - fantasia 1

06703 - fantasia 2



06704

06705

Conf. 10 fogli cm.29,7x42 gr.120

06704 - fantasia 1

06705 - fantasia 2

Carta Collage

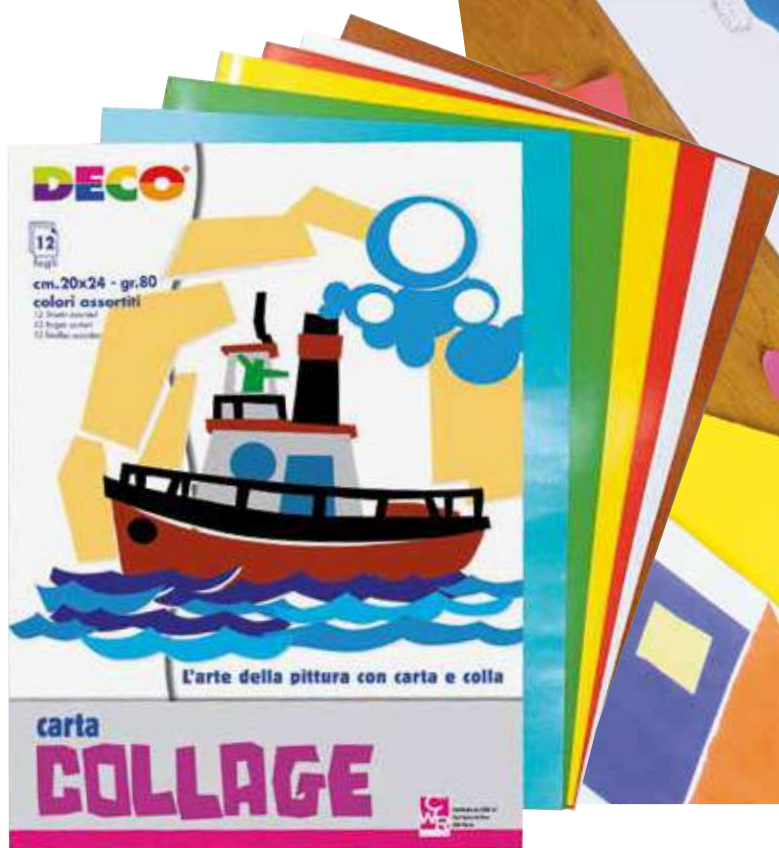

Rasata lucida GR.80

Un prodotto indispensabile per attività didattiche. Dai colori lucidi e brillanti, questa carta è anche leggera, facile da ritagliare e incollare, e si presta alla realizzazione di moltissimi lavori didattici.

Album COLORI ASSORTITI

700/12 - cm. 20x24 (12 fogli)

701/12 - cm. 24x34 (12 fogli)

08299 - cm. 35x50 (12 fogli)

714/24 - cm. 35x50 (24 fogli)

703/50 - cm. 35x50 (50 fogli)

703/70 - cm. 50x70 (50 fogli)

08300 - cm. 50x70 (busta 12 fogli)

Album 24 fogli cm. 35x50

conf./monocolore

- **703/24/1** Rosso
- **703/24/2** Verde
- **703/24/3** Blu
- **703/24/4** Giallo
- **703/24/5** Azzurro
- **703/24/6** Rosa
- **703/24/7** Marrone
- **703/24/8** Bianco
- **703/24/9** Nero
- **703/24/10** Arancio
- **703/24/11** Oro
- **703/24/12** Argento

Album 12 fogli cm. 50x70

conf./monocolore

- **08301** Rosso
- **08302** Verde
- **08303** Blu
- **08304** Giallo
- **08305** Azzurro
- **08306** Rosa
- **08307** Marrone
- **08308** Bianco
- **08309** Nero
- **08310** Arancio
- **08311** Oro
- **08312** Argento

Rasata lucida GR.80 adesiva

Album COLORI ASSORTITI

700/6 - cm.20x24 (6 fogli)





701/6 - cm.24x34 (6 fogli)

700/20 - cm.35x50 (20 fogli)

2154/24 - cm.50x70 (24 fogli)

Busta 10 fogli cm.50x70

conf./monocolore

- **2154/10/03**  Blu
- **2154/10/04**  Giallo
- 2154/10/06**  Rosa
- **2154/10/08**  Bianco
- 2154/10/09**  Nero



Rasata lucida GR.80 adesiva trasparente

733/12

busta 12 fogli colori assortiti cm.21x29,7
Utilizzabile su: vetro, plastica, metallo, ecc...



Carta trasparente





Carta trasparente di pura cellulosa gr.110. Simile alla carta per lucidi ma più consistente e robusta. Disponibile in 5 diverse fantasie che si addicono a ogni occasione.

1 foglio cm.50x70

- 07185**  Motivi musicali
- 07187**  Jamaica
- 07191**  Cuori
- **07193**  Stelle

10 fogli cm.23x33

conf./monosoggetto

- 07184**  Motivi musicali
- 07186**  Jamaica
- 07188**  Fiori
- **07190**  Cuori
- 07192**  Stelle

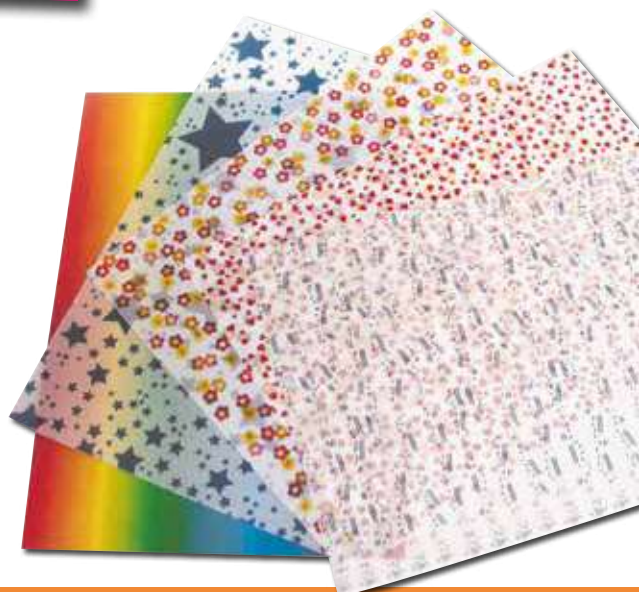

Carta Velina

Una carta leggerissima e semi-trasparente per realizzare lavoretti che risaltano se esposti alla luce.

RESISTENTE E DI ALTA QUALITÀ supporta egregiamente ogni tipo di collante!



Busta 24 fogli unicolore cm.50x76 GR.20

| | | |
|-------|--|--------------------|
| 05310 | | Bianco |
| 12087 | | Avorio |
| 05311 | | Giallo |
| 12088 | | Giallo girasole |
| 05312 | | Arancio |
| 05313 | | Rosso |
| 12089 | | Rosa carne |
| 05314 | | Rosa |
| 12090 | | Violetto (glicine) |
| 05315 | | Viola |
| 12091 | | Azzurro baby |
| 05316 | | Azzurro |
| 05317 | | Blu |
| 12092 | | Verde lime |
| 05318 | | Verde chiaro |
| 05319 | | Verde scuro |
| 05320 | | Marrone |
| 05321 | | Nero |
| 05322 | | Oro |
| 05323 | | Argento |

Busta 5 fogli unicolore cm.50x76 GR.20

| | | |
|----------|--|--------------|
| 12283/01 | | Bianco |
| 12283/04 | | Avorio |
| 12283/02 | | Giallo |
| 12283/06 | | Rosso |
| 12283/21 | | Rosa |
| 12283/12 | | Azzurro baby |
| 12283/13 | | Azzurro |
| 12283/14 | | Blu |
| 12283/16 | | Verde chiaro |
| 12283/20 | | Nero |

Busta 5 fogli PERLESCENTE cm.50x76 GR.20

| | | |
|----------|--|------------------------|
| 12295/01 | | Bianco PERLESCENTE |
| 12295/02 | | Oro chiaro PERLESCENTE |
| 12295/03 | | Oro scuro PERLESCENTE |



Busta 5 fogli METALLIZZATO cm.50x76 GR.20

| | | |
|---------|--|----------------------|
| 12455/1 | | Oro METALLIZZATO |
| 12455/2 | | Argento METALLIZZATO |

Carta velina



Album COLORI ASSORTITI GR.20

- 706/24** - cm.24x34 (24 fogli)
- 10876** - cm.25x35 (24 fogli)
- 706/20** - cm.35x50 (20 fogli)
- 09114** - cm.50x76 (240 fogli/10 colori)
- 05406** - cm.50x76 (25 fogli, 5 colori)
- 09382** - cm.50x76 (50 fogli, 10 colori)
- 10732** - cm.50x76 (25 fogli, 5 colori caldi) ☀️

- 10733** - cm.50x76 (25 fogli, 5 colori freddi) ❄️

Carta velina bianca

Ideale per avvolgere, proteggere e presentare i prodotti. È utilizzata per gli album fotografici, e anche per realizzare decorazioni creative che risaltano se esposte alla luce.

12680

PACK SCUOLA

cm.100x140 (100 fogli) gr.22/24

ogni foglio è piegato singolarmente

707/K10

CONFEZIONE RISPARMIO

carta velina bianca per modelli

cm.100x150 gr.22/24 risma kg.10

(circa 300 fogli)



Carta pergamina

Indicata per realizzare fantastici aquiloni, lampade, decorazioni sfruttando la trasparenza di questo materiale e il conseguente effetto che si ottiene esponendolo alla luce.

Album COLORI ASSORTITI

2081

cm.24x34 (14 fogli)

2180

cm.70x100 (25 fogli)

(10 rossi, 5 verdi, 5 gialli, 5 blu)



Carta vellutata

EFFETTO PANNO

Morbida e resistente a qualsiasi tipo di collante. Può essere applicata su svariati materiali, in particolare su quelli porosi (cartoncini, carta)



GR.130

Album COLORI ASSORTITI

710/6 - cm.20x24 (6 fogli)

700/ - cm.20x24 (10 fogli)

710/10 - cm.24x34 (10 fogli)

713/30 - cm.35x50 (30 fogli)

713/50 - cm.35x50 (50 fogli)



Rotolo unicolore
MT.5x70 cm.

- 2110/1** ● Rosso
- 2110/2** ● Verde
- 2110/3** ● Blu
- 2110/4** ● Giallo
- 2110/5** ● Azzurro
- 2110/6** ● Rosa
- 2110/7** ● Marrone
- 2110/8** ● Bianco
- 2110/9** ● Nero
- 2110/10** ● Arancio
- 2110/11** ● Viola
- 2110/12** ● Verde scuro



10 fogli unicolore
cm.50x70

- 2120/1x10** ● Rosso
- 2120/2x10** ● Verde
- 2120/3x10** ● Blu
- 2120/4x10** ● Giallo
- 2120/5x10** ● Azzurro
- 2120/6x10** ● Rosa
- 2120/7x10** ● Marrone
- 2120/8x10** ● Bianco
- 2120/9x10** ● Nero
- 2120/10x10** ● Arancio
- 2120/11x10** ● Viola
- 2120/12x10** ● Verde scuro



Album 24 fogli unicolore
cm.35x50

- 713/24/2** ● Verde
- 713/24/7** ● Marrone
- 713/24/9** ● Nero
- 713/24/11** ● Viola
- 713/24/12** ● Verde scuro

Carta vellutata adesiva

EFFETTO PANNO

Rotolo unicolore ADESIVO
mt.2x50 cm.

- 2115/1 ● Rosso
- 2115/2 ● Verde
- 2115/3 ● Blu
- 2115/4 ● Giallo
- 2115/5 ● Azzurro
- 2115/6 ● Rosa
- 2115/7 ● Marrone
- 2115/8 ○ Bianco
- 2115/9 ● Nero
- 2115/10 ● Arancio



Album COLORI ASSORTITI

700/7 - cm.20x24 (7 fogli)

701/7 - cm.24x34 (7 fogli)

702/12 - cm.35x50 (12 fogli)

Carta vivelle

EFFETTO SPUGNA



SET VIVELLE 10 FG. ASSORTITI

● 04768 - cm.23x33

● 2146 - cm.35x50



06089

set VIVELLE ADESIVA
10 fogli cm.23x33

Carte speciali



CARTA RIGHE E POIS GR.90
COLORI ASSORTITI (STAMPA SU ENTRAMBI I LATI)

- UR291** - cm.14 ø (100 fogli)
- UR289** - cm.14x14 (100 fogli)
- 04842** - cm.23x33 (20 fogli)
- 05407** - cm.70x100 (rotolo 10 fogli)

CARTA COLLAGE DELLE COSTRUZIONI

08990
9 fogli **ADESIVI** cm.23x33

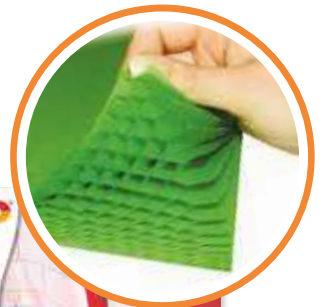

Tenendo il foglio chiuso ritagliate la forma desiderata e apritela, fissando le due estremità con la colla.

CARTA MURALES OPACA GR.100
COLORI ASSORTITI

- 2071**
cm.35x50 (30 fogli)
- 2070**
cm.70x100 (rotolo 10 fogli)

CARTA DA PACCO COLORATA
MILLERIGHE GR.60

- COLORI ASSORTITI
- 2212**
cm.35x50 (50 fogli)
- 2214**
cm.70x100 (rotolo 24 fogli)

CARTA ALVEARE
COLORI ASSORTITI

- 05804**
cm.25x34 (5 fogli)





CARTA STELLE GR.100
 COLORI ASSORTITI
 (RETRO UNICOLORE)
05953
 cm.23x33 (12 fogli)
05954
 cm.70x100 (rotolo 12 fogli)



CARTA FIORI GR.80
 COLORI ASSORTITI
 (RETRO UNICOLORE)
05955
 cm.23x33 (12 fogli)
05956
 cm.70x100 (rotolo 12 fogli)



CARTA FANTASIA GR.80
 COLORI ASSORTITI
 (RETRO UNICOLORE)
06056
 cm.23x33 (12 fogli)



CARTA FLUORESCENTE GR.80
 COLORI ASSORTITI
 ● **746**
 cm.24x34 (12 fogli)
 ● **748**
 cm.50x70 (24 fogli)
2151
 cm.35x50 (20 fogli **ADESIVI**)



CARTA ARCOBALENO GR.100
 SFUMATURE ASSORTITE
 (RETRO UNICOLORE)
UR1521
 cm.23x33 (10 fogli)
 ● **05434**
 cm.50x70 (10 fogli **ADESIVI**)



CARTA JUNGLE GR.80
 SOGGETTI E COLORI ASSORTITI
 (RETRO UNICOLORE)
04843
 cm.23x33 (20 fogli)
04840
 cm.35x50 (10 fogli)
04745
 cm.70x100 (rotolo 10 fogli)

Carta olografica

CARTA OLOGRAFICA
 COLORI ASSORTITI
06069
 MT. 1x45 cm. (5 ROTOLI **ADESIVI**)



CARTA METALLIZZATA COLORCROM
 COLORI ASSORTITI
2172
 cm.50x70 (10 fogli **ADESIVI**)



CARTA OLOGRAMMI
 COLORI ASSORTITI
2165
 cm.14x14 (10 fogli **ADESIVI**)



CARTA OLOGRAFICA
 STELLE OLOGRAFICHE METALLIZZATE
10531
 cm.21x29,7 (15 fogli **ADESIVI**)

Carta metallizzata



CARTA METALLIZZATA GR.80
2155 - cm.24x34 (10 fogli assortiti)
2156 - cm.35x50 (10 fogli assortiti)
2157 - cm.50x70 (5 oro + 5 argento)

CARTA METALLIZZATA GR.80 **ADESIVA**
10532 - cm.21x29,7 formato A4 (15 fogli assortiti)



Laminato metallizzato

Laminato double-face in alluminio anodizzato lucido. Si piega e modella con facilità. Rotolo cm.50x80

Rotolo unicolore
cm.50x80

810/A ● Argento
810/O ● Giallo
810/R ● Rosso

Carta origami



CARTA ORIGAMI TEMPERA GR.80
 COLORI OPACHI ASSORTITI
743 - cm.35x50 (50 fogli)
744 - cm.50x70 (50 fogli)



CARTA ORIGAMI GR.80
 COLORI ASSORTITI
740 - cm.10x10 (100 fogli)
741 - cm.14x14 (20 fogli) + istruzioni



CARTA ORIGAMI METAL GR.80
 COLORI METALLIZZATI ASSORTITI
745
 cm.14x14 (24 fogli) + istruzioni

Set origami

Tutto l'occorrente per costruire 5 diversi animali con la tecnica dell'origami e le piegature tratteggiate. Nella confezione sono incluse le istruzioni illustrate per il montaggio di ogni animale.

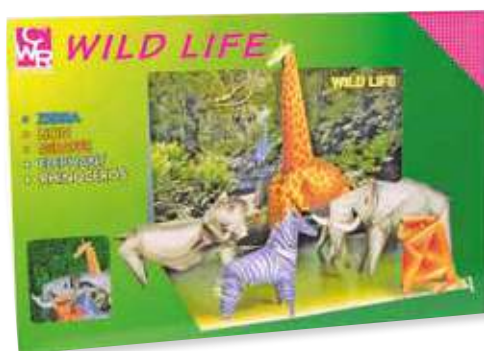

742
 set origami 5 animali assortiti
 (4 tavole cm.29x43, 4 tavole cm.26x32)



Carta Crespa



**OGNI ROTOLO È
IMBUSTATO
SINGOLARMENTE**

**32
gr.**

**Rotolo colori speciali
cm.250x50**

| | | |
|--------------|--|--------------|
| 05121 | | Oro |
| 05122 | | Argento |
| 05123 | | Giallo fluo |
| 05124 | | Arancio fluo |
| 05125 | | Fuxia fluo |
| 05126 | | Verde fluo |

**40
gr.**

PACK SCUOLA

**Rotolo cm.250x50
COLORI ASSORTITI**

10369 - 10 rotoli (est. 140%)

07786 - 30 rotoli (est. 140%)

05100 - 100 rotoli (est. 140%)

10711 - 6 rotoli colori caldi



10712 - 6 rotoli colori freddi



**40
gr.**

Rotolo cm.250x50

SPECIALE SCUOLA

| | | |
|-----------------|--|---------------|
| 10713/01 | | Bianco |
| 10713/02 | | Giallo |
| 10713/03 | | Becco d'oca |
| 10713/04 | | Crema |
| 10713/05 | | Arancio |
| 10713/06 | | Rosso Natale |
| 10713/07 | | Rosa carne |
| 10713/21 | | Rosa baby |
| 10713/08 | | Rosa |
| 10713/10 | | Fuxia |
| 10713/11 | | Violetto |
| 10713/12 | | Azzurro Baby |
| 10713/13 | | Azzurro cielo |
| 10713/14 | | Blu |
| 10713/15 | | Blu cobalto |
| 10713/16 | | Verde chiaro |
| 10713/17 | | Verde medio |
| 10713/18 | | Verde scuro |
| 10713/19 | | Marrone |
| 10713/20 | | Nero |

**40
gr.**

Rotolo cm.250x50

estensione 140%

| | | |
|--------------|--|------------------|
| 05101 | | Bianco |
| 05102 | | Giallo pallido |
| 07973 | | Giallo limone |
| 05103 | | Becco d'oca |
| 05104 | | Arancio |
| 05105 | | Rosso Natale |
| 05106 | | Bordeaux |
| 07972 | | Rosa baby |
| 05107 | | Rosa pallido |
| 05108 | | Fuxia |
| 07974 | | Viola |
| 05109 | | Azzurro cielo |
| 05110 | | Azzurro turchese |
| 07975 | | Blu oltremare |
| 05111 | | Blu scuro |
| 05112 | | Verde chiaro |
| 05113 | | Verde bandiera |
| 05114 | | Verde muschio |
| 05115 | | Marrone |
| 05116 | | Nero |



60
gr.

PACK SCUOLA
Rotolo cm.250x50
COLORI ASSORTITI

07787 - 30 rotoli
07420 - 100 rotoli

**RESISTENTE
ED ELASTICA
SUPPORTA
EGREGIAMENTE
OGNI TIPO
DI COLLANTE**

60
gr.

Rotolo cm.250x50

estensione 175%

- 07421** Bianco
- 07422** Giallo pallido
- 08856** Giallo limone
- 08857** Becco d'oca
- 07423** Arancio
- 08858** Rosso Natale
- 07424** Bordeaux
- 07425** Rosa baby
- 08851** Rosa pallido
- 07426** Fuxia
- 08852** Viola
- 08854** Azzurro cielo
- 08855** Azzurro turchese
- 07427** Blu oltremare
- 07428** Blu scuro
- 07429** Verde chiaro
- 08853** Verde bandiera
- 07430** Verde muschio
- 07431** Marrone
- 07432** Nero

180
gr.

Rotolo cm.250x50

estensione 260%

- 08171** Bianco
- 08172** Giallo pallido
- 08173** Giallo vivo
- 08174** Arancio
- 08175** Becco d'oca
- 08176** Rosso
- 08177** Rosso cardinale
- 08178** Rosa pallido
- 08179** Rosa baby
- 08180** Fuxia
- 08181** Viola
- 08182** Azzurro baby
- 08183** Celeste
- 08184** Turchese
- 08185** Blu oltremare
- 08186** Verde chiaro
- 08187** Verde bandiera
- 08188** Verde muschio
- 08189** Marrone
- 08190** Nero

Carta crespa

Rotolo BICOLORE
cm.150x70 gr.160

- 831/1  Rosso/Blu
- 831/2  Verde/Oro
- 831/4  Giallo/Argento

Rotolo METALLIZZATO
cm.150x50 gr.50

- 2196/1  Oro
- 2196/2  Argento
- 2196/3  Rosso
- 2196/4  Verde
- 2196/5  Blu



2220
mt.5x5 cm. gr.32 (10 rotoli)
crespa colori assortiti



● **2221**
mt.10x10 cm. gr.45 (3 rotoli)
crespa tricolore



1761
ø mm.6x40 cm. (100 tubetti)
Indicati per bandierine e usi didattici



1760x50
ø mm.1x70 cm.
50 fili plastificati per fiori



Carta riso- Carta cotone

Carta interamente lavorata a mano. Ogni foglio è caratterizzato da venature irregolari e da inserti che lo rendono unico. Ideale come carta da regalo e per rivestire scatole e libri, la carta riso assicura ottimi risultati anche se utilizzata per creare oggetti tridimensionali, composizioni, biglietti di auguri, fondi, lavori di *découpage* e scrapbooking.



Busta COLORI ASSORTITI

10414

cm.50x70 gr.25 (10 fogli)

10413

cm.70x100 gr.25 (10 fogli)

Busta 10 fogli unicolore cm.70x100 GR.25

| | | |
|-----------------|---|----------------|
| 10403x10 |  | Bianco |
| 10404x10 |  | Tabacco |
| 10405x10 |  | Giallo Pallido |
| 10406x10 |  | Verde Acido |
| 10407x10 |  | Rosso Fuoco |
| 10408x10 |  | Rosa Baby |
| 10409x10 |  | Arancio |
| 10410x10 |  | Lilla |
| 10411x10 |  | Azzurro |
| 10412x10 |  | Blu Scuro |



08051

carta BIANCA
10 fogli cm.50x70 gr.25



05220

carta FOGLIE assortita
3 fogli cm.50x70 gr.35



2034

carta COTTON
12 fogli cm.64x94 gr.45
assortiti in 6 colori
Resistente, effetto "stropicciato"



UR1405

carta MALESIA
10 fogli cm.23x33 gr.40
Realizzata a mano, con petali
di fiori e fili d'erba



Carte decorative e per scrapbooking

Carta ideale per realizzare biglietti d'auguri e lavori di scrapbooking!

OGNI FOGLIO È DOUBLE FACE



Assortimento "Tinte e Tonalità"

12591

confezione 24 fogli di carta double-face colori assortiti su entrambi i lati (tono su tono)
foglio: cm.30,5 x 30,5 - 180 gr



Assortimento "Vichy"

12592

confezione 30 fogli di carta double-face colori e motivi diversi su entrambi i lati
foglio: cm.30,5 x 30,5 - 180 gr



Assortimento "Provenzale"

12593

confezione 7 fogli di carta double-face colori assortiti su entrambi i lati
foglio: cm.30,5 x 30,5 - 180 gr



Assortimento "Texture Tessitura"

12594

confezione 24 fogli di carta double-face colori e motivi diversi su entrambi i lati
foglio: cm.30,5 x 30,5 - 180 gr

Carte per cartonaggio

Indicate per lavori di cartonaggio e rivestimento: leggere, coprenti, facili da piegare e ritagliare, supportano i collanti.

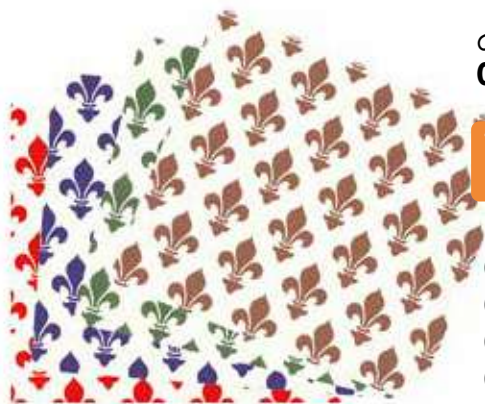

CARTA VARESE GR.100
04966 - cm.70x100 (12 fogli)

**Rotolo 12 fogli unicolore
cm.70x100 gr.100**

- 04967**  Rosso
- 04968**  Blu
- 04969**  Verde
- 04970**  Marrone

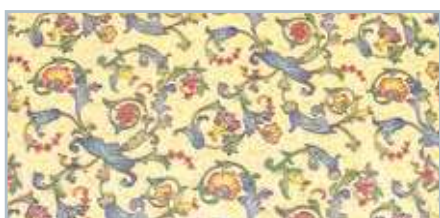

CARTA FIORI GR.100

● **06708**
cm.70x100 (10 fogli)



CARTA FIORATA GR.100

04808 - cm.70x100 (12 fogli)



INDICATE PER LAVORI
DI SCRAPBOOKING!

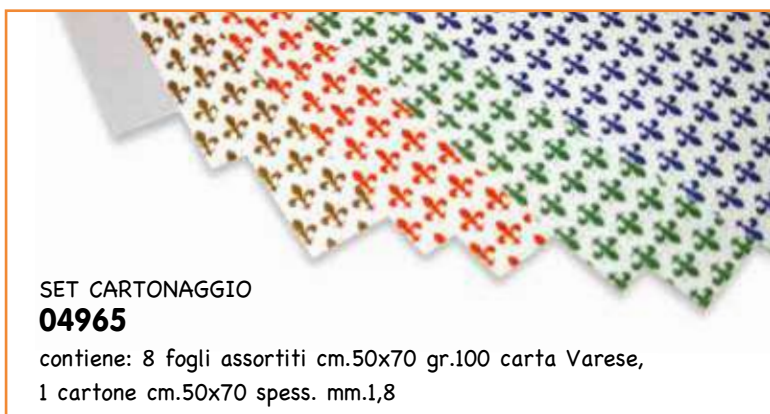

SET CARTONAGGIO

04965

contiene: 8 fogli assortiti cm.50x70 gr.100 carta Varese,
1 cartone cm.50x70 spess. mm.1,8



ASSORTIMENTO

● **07246**

cm.35x50 (6 fogli)

Stecca per legatoria

Indicata nei lavori di cartonaggio e rilegatura per aumentare la pressione da esercitare lungo il dorso ed accentuare le piegature della tela e del cartone, così da rendere più robusto il dorso e le relative piegature più nette.



06121x6

6 stecche per legatoria
cm.16 "pieghetta"



pag.276
colla per legatoria

Cartoncini didattici



Cartoncino BIANCO

Cartoncini didattici ad alto spessore ideali per i più svariati utilizzi. Possono essere trattati con tempere, pennarelli, matite, pastelli, gessi, crete, carboncini, pastelli a cera, colori a dita e con qualsiasi altro tipo di colore, che non trapasserà il cartone.

CARTONCINO BIANCO GR.380

06290 - cm.25x35 (10 cartoncini)

06291 - cm.35x50 (10 cartoncini)

06292 - cm.50x70 (10 cartoncini)

CARTONCINO BIANCO OPACO GR.220

06274 - cm.50x70 (10 cartoncini)

CARTONCINO BIANCO OPACO GR.400

06275 - cm.50x70 (10 cartoncini)

CARTONCINO BIANCO LUCIDO/OPACO GR.300

9605 - cm.70x100 (1 cartoncino)

Cartoncini BRISTOL COLORATI



BRISTOL COLORI ASSORTITI GR.200

- 715/10** - cm.25x35 (10 cartoncini)
- 715/15** - cm.25x35 (15 cartoncini)
- 716/15** - cm.35x50 (15 cartoncini)
- 704/21** - cm.35x50 (21 cartoncini)
- 705/21** - cm.50x70 (21 cartoncini)
- 717/15** - cm.50x70 (15 cartoncini)

PACK SCUOLA

BRISTOL COLORI ASSORTITI GR.200

- 717/24** - cm.50x70 (24 cartoncini)
- 24 COLORI DIFFERENTI

PACK SCUOLA

BRISTOL ASSORTITI GR.200

- 716/60** - cm.35x50 (60 cartoncini)
- 717/60** - cm.50x70 (60 cartoncini)
- 718/60** - cm.70x100 (60 cartoncini)



BRISTOL unicolore cm.50x70 GR.200

- 717/1/15** Bianco
- 717/1/16** Avorio
- 717/1/01** Giallo chiaro
- 717/1/02** Giallo oro
- 717/1/03** Nocciola
- 717/1/04** Azzurro cielo
- 717/1/05** Azzurro mare
- 717/1/06** Blu
- 717/1/07** Verde chiaro
- 717/1/08** Verde scuro
- 717/1/09** Grigio
- 717/1/10** Rosa
- 717/1/11** Arancio
- 717/1/12** Rosso
- 717/1/13** Violetto
- 717/1/14** Nero

BRISTOL unicolore cm.70x100 GR.200

- 718/15** Bianco
- 718/16** Avorio
- 718/01** Giallo chiaro
- 718/02** Giallo oro
- 718/03** Nocciola
- 718/04** Azzurro cielo
- 718/05** Azzurro mare
- 718/06** Blu
- 718/07** Verde chiaro
- 718/08** Verde scuro
- 718/09** Grigio
- 718/10** Rosa
- 718/11** Arancio
- 718/12** Rosso
- 718/13** Violetto
- 718/14** Nero

ALTRE GRAMMATURE E RISME COLORATE

A PAG. 4



GR.160

12304/100 - 100 fogli A4 (colori tenui)

12306/100 - 100 fogli A4 (colori forti)

GR.200

12308/100 - 100 fogli A4 (colori tenui)

12310/100 - 100 fogli A4 (colori forti)



Cartoncino in striscioline

Ideali per creare collage e decorazioni anche con la tecnica del Quilling che consiste nel modellare le strisce di carta colorata in riccioli e fermarli con una goccia di colla... il gioco è fatto!



09377

Cartoncino GR.160 COLORI ASSORTITI

09119 - cm.1,5x50 (200 strisce)

09120 - cm.2x50 (200 strisce)

09121 - cm.4x50 (200 strisce)

09122 - cm.10x50 (200 strisce)

09377

contenitore in legno per strisce di cartoncini
cm.55x17x7 h (cartoncini esclusi)



09299

cm.35x50 (10 cartoncini colori assortiti)



Cartoncini didattici

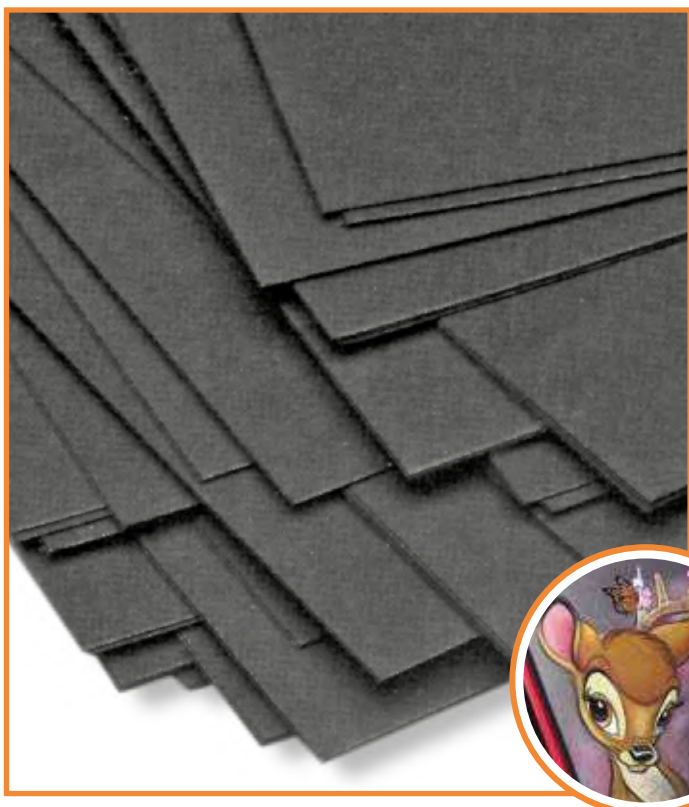

CARTA e CARTONCINO NERO

12299/121 - A4 (100 fogli) **GR.80**

12306/121 - A4 (100 fogli) **GR.160**

12310/121 - A4 (100 fogli) **GR.200**

● **06039** - cm.8x11 (50 cartoncini) **GR.200**

06293 - cm.25x35 (10 cartoncini) **GR.200**

06294 - cm.50x70 (10 cartoncini) **GR.200**



CARTONCINO BLACK & WHITE GR.240

728x10

cm.50x70 (10 cartoncini)

Un lato bianco e un lato nero



CARTONCINO AVANA (su due lati) GR.500

10968x10

cm.50x70 (10 cartoncini) un lato ruvido e uno liscio

10969

cm.70x100 (1 cartoncino) un lato ruvido e uno liscio

CARTONCINO BIANCO GR.500

10966x10

cm.50x70 (10 cartoncini) non patinato, retro manila

10967

cm.70x100 (1 cartoncino) non patinato, retro manila



Supporto perfetto per colori a olio, tempera, acrilici, paste a rilievo...

CARTONCINO TELATO BIANCO/AVORIO GR.160

08057 - cm.23x33 (10 cartoncini)

08058 - cm.50x70 (10 cartoncini)



INDICATO PER
RITAGLIARE,
RICALCARE E PER
CREARE LAVORI
CON GIOCHI
DI LUCE

CARTONCINO TRASPARENTE "OPALINE" GR.200

729x10

cm.50x70 (10 cartoncini)

Cartoncino BICOLORE



CARTONCINO DIDATTICO BICOLORE **GR.400**
05396

cm.35x50 (10 cartoncini colori assortiti)





04925

cm.50x70 (10 cartoncini colori assortiti)

04926

cm.50x70 (10 cartoncini colori natalizi)

10 cartoncini bicolore (opaco/lucido)
cm.50x70 gr.400

- 05921x10**  Oro/Rosso
- 05922x10**  Argento/Arancio
- 05923x10**  Blu/Verde
- 05924x10**  Giallo/Marrone
- 05925x10**  Rosa/azzurro

Cartone vegetale

Cartoni pesanti "tipo legatoria".
Per lavori di cartonaggio e scrapbooking.

Cartone vegetale pesante grigio

- 04369** - cm.50x70 mm.1,5
- 11226** - cm.71x101 mm.1,5
- 04370** - cm.50x70 mm.1,8
- 04371** - cm.71x101 mm.1,8
- 04372** - cm.50x70 mm.2,2
- 11227** - cm.71x101 mm.2,2
- 04373** - cm.50x70 mm.2,8
- 11228** - cm.71x101 mm.2,8

CARTONE VEGETALE PESANTE GRIGIO
11230x10
cm.25x35 mm.1,8 (10 cartoncini)



Cartone pesante

08968

10 cartoni pesanti cm.50 x 70 - assortiti nei vari modelli
(2 cartoni black, 2 bianco/bianco, 2 avorio, 2 oro/argento, 2 cuoio)



CARTONE NERO MM.1,5
08957x10
cm.23x33 (10 cartoncini)
08956x10
cm.35x50 (10 cartoncini)
08955x10
cm.50x70 (10 cartoncini)
08954x18
cm.70x100 (18 cartoncini)



CARTONE BIANCO MM.1,3
08965x10
cm.50x70 (10 cartoncini)
08964x18
cm.70x100 (18 cartoncini)



CARTONE AVORIO MM.1,3
08967x10
cm.50x70 (10 cartoncini)
08966x18
cm.70x100 (18 cartoncini)



CARTONE ORO/ARGENTO MM.1,2
08963x10
cm.23x33 (10 cartoncini)
08962x10
cm.35x50 (10 cartoncini)
08961x10
cm.50x70 (10 cartoncini)
08960x18
cm.70x100 (18 cartoncini)



CARTONE CUOIO MM.1,6
08959x10
cm.50x70 (10 cartoncini)
08958x18
cm.70x100 (18 cartoncini)

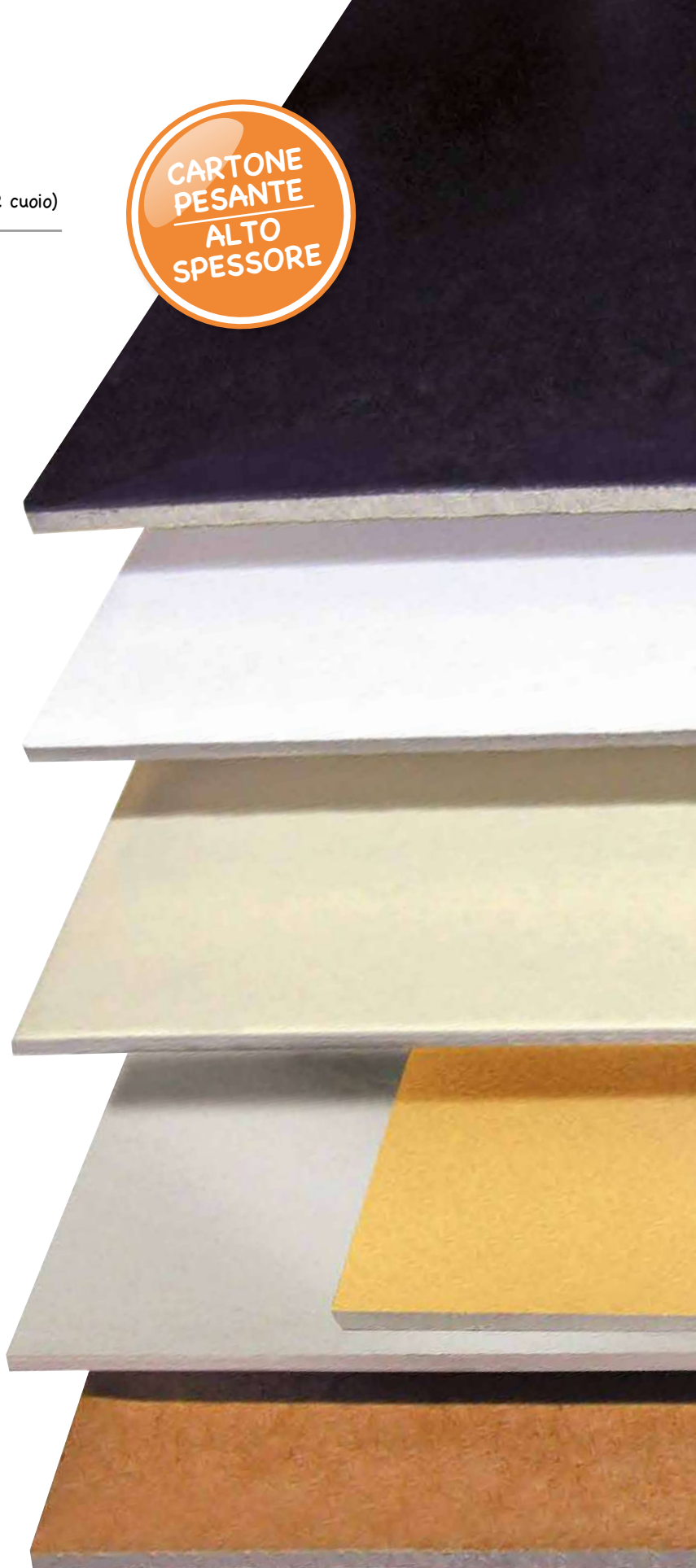

Cartoncini speciali



CARTONCINO CALIPSO GR.180
COLORI ASSORTITI

07636

cm.23x33 (30 cartoncini)

07637

cm.35x50 (30 cartoncini)



CARTONCINO PASTELLO GR.180
COLORI ASSORTITI

04190

cm.25x35 (14 cartoncini)

781

cm.35x50 (21 cartoncini)



CARTONCINO PRIMAVERA GR.180
COLORI ASSORTITI

07143

cm.50x70 (14 cartoncini)



CARTONCINO JUNIOR GR.150
COLORI ASSORTITI

06266

cm.21x29,7 (80 cartoncini)

06267

cm.24x33 (10 cartoncini)

07666

cm.23x33 (40 cartoncini)

07667

cm.35x50 (20 cartoncini)



CARTONCINO ARCOBALENO GR.400
SFUMATURE ASSORTITE

05433

cm.50x70 (10 cartoncini)

Cartoncino stampato con i colori dell'arcobaleno; ogni foglio è differente dagli altri per sfumature ed abbinamenti di colore.



CARTONCINO DEGRADE GR.120
COLORI SFUMATI ASSORTITI

2242

cm.50x70 (20 cartoncini)

Su ogni cartoncino il colore passa dalla gradazione più intensa a quella più tenue, consentendo così di realizzare scenografie, collage, disegni, ecc.



INDICATI
PER LE SCUOLE
utili per affinare
lo sviluppo tattile
del bambino

EFFETTO PANNO

CARTONCINO VELLUTO GR.400
COLORI ASSORTITI

05216
cm.50x70 (10 cartoncini)

album 10 cartoncini cm.50x70

conf./monocolore

06282x10 Bianco

06283x10 Giallo

06284x10 Rosso

06285x10 Verde

06286x10 Blu

06287x10 Nero



CARTONCINO FLUORESCENTE
GR.260 COLORI ASSORTITI

06152
cm.25x35 (10 cartoncini)

2150/10
cm.50x70 (10 cartoncini)

album 10 cartoncini cm.50x70

conf./monocolore

737/2x10 Verde

737/3x10 Ciclamino

737/4x10 Arancio

737/5x10 Giallo



CARTONCINO RIGHE & POIS GR.300
COLORI ASSORTITI

UR1520
cm.23x33 (10 cartoncini)

04841
cm.50x70 (10 cartoncini)

Cartoncini a righe e pois stampati
su entrambi i lati. Supportano ogni
tipo di colore, colle stick e viniliche.



CARTONCINO FANTASIA GR.400
SOGGETTI E COLORI ASSORTITI

UR1282
cm.50x70 (10 cartoncini)

Stampati su entrambi i lati. Possono
essere utilizzati anche per costruire
oggetti tridimensionali.



CARTONCINO CUORI GR.300
COLORI ASSORTITI

05951
cm.25x35 (12 cartoncini)

05952
cm.50x70 (12 cartoncini)

Originali cartoncini assortiti in vari
colori e impreziositi da una stampa
a cuoricini. Retro unicolore.

Cartoncini speciali



CARTONCINO JUNGLE GR.400
FANTASIE ASSORTITE

UR1291

cm.23x33 (10 cartoncini)

04262

cm.50x70 (10 cartoncini)

Riproduce il manto di svariati animali.
Retro unicolore.



CARTONCINO STELLE PICCOLE
GR.300 - COLORI ASSORTITI

05947

cm.25x35 (12 cartoncini)

05948

cm.50x70 (12 cartoncini)

Cartoncini impreziositi da piccole
stelle stampate su ogni foglio.
Retro unicolore.



CARTONCINO STELLE GRANDI
GR.300 - COLORI ASSORTITI

05949

cm.25x35 (12 cartoncini)

05950

cm.50x70 (12 cartoncini)

Cartoncini stellati assortiti in
vari colori. Retro unicolore.

Cartoncini oro e argento

Indicati per realizzare oggetti tridimensionali con la tecnica del cartongaggio, oppure lavori di scrapbooking, vetrinistica ecc.



CARTONCINO PERLESCENTE GR.300

07289

cm.35x50 (10 cartoncini)
colore bianco perlescente

07292

cm.50x70 (10 cartoncini)
colore oro e argento perlescente

09749

cm.50x70 (10 cartoncini)
colore oro perlescente



CARTONCINO METALIK GR.320

08983

cm.50x70 (10 cartoncini) oro

08984

cm.23x33 (10 cartoncini) oro

08985

cm.50x70 (10 cartoncini) argento

08986

cm.23x33 (10 cartoncini) argento



CARTONCINO SATINATO
EFFETTO OPACO

06308

cm.25x35 gr.300 (4 oro, 4 argento)

08202

cm.25x17,5 gr.260 (8 oro, 8 argento)

08203

cm.50x70gr.260 (5 oro, 5 argento)

Cartoncino artkraft satinato/metal

Cartoncino pesante satinato, dall'effetto opaco, che ricorda i colori degli antichi metalli. Molto indicato per raffinate rilegature, menù, scrapbooking...

CARTONCINO ARTKRAFT SATINATO GR.300

07290

cm.23x33 (10 cartoncini)
colori metallizzati/satinati assortiti

07291

cm.35x50 (10 cartoncini)
colori metallizzati/satinati oro e argento

CARTONCINO ARTKRAFT SATINATO GR.340

08982

cm.23x33 (10 cartoncini) oro

08981

cm.50x70 (10 cartoncini) oro



Cartoncino a specchio

Cartoncino lucido a specchio. Riflette le immagini e la luce rendendo unico ogni lavoro realizzato. Facile da tagliare e incollare. Retro bianco.

724

cartoncino cm.50x70 gr.250



Laminato ardesiante nero

Laminato ardesiante cancellabile per gessi e per marker "Gesso liquido". I fogli, pur conservando le principali caratteristiche delle classiche lavagne a muro, sono molto più pratici e leggeri: possono essere spostati senza fatica e appesi a muri, pannelli ecc.

● **09383**

laminato cm.60x84 mm.0,5

04974

laminato cm.50x70 mm.0,5

● **09219**

laminato cm.70x100 mm.0,5



Cannete' (cartone ondulato)



Duttile e consistente, largamente adoperato nelle attività didattiche, grafiche, cartellonistiche e di cartonaggio, supporta egregiamente i collanti più difficili.

CANNETE' COLORI ASSORTITI GR.230

2200 - cm.25x35 (10 cartoncini)

2205 - cm.50x70 (10 cartoncini)

10 CANNETE' unicolore cm.50x70 gr.230

| | |
|-----------------------------|---------------------------------|
| 2206/1 ● Rosso | 2206/9 ● Azzurro |
| 2206/2 ● Blu | 2206/10 ● Verde chiaro |
| 2206/3 ● Verde scuro | 2206/11 ● Arancione |
| 2206/4 ● Giallo | 2206/12 ● Marrone |
| 2206/5 ● Avana | 2206/13 ● Blu scuro |
| 2206/6 ● Bianco | 2206/14 ● Viola |
| 2206/7 ● Nero | 2206/15 ● Arancio chiaro |
| 2206/8 ● Rosa | 2206/16 ● Marrone chiaro |

LETTERS
123

NOVITA'

12920

set 10 fogli (1000 pezzi)
lettere e numeri in cartone
altezza cm.3
colori assortiti



Cannete' metallizzato

CANNETE' METAL COLORI ASSORTITI GR.230

07433 - cm.25x35 (10 cartoncini)

2225/A - cm.50x70 (10 cartoncini)

10 CANNETE' METAL cm.50x70 gr.230

conf./monocolore

2225/1 ● Oro

2225/2 ● Argento

2225/3 ● Rosso

2225/4 ● Verde



Cannete' waves

CANNETE' WAVES

2210 - cm.50x70 (10 cartoncini)

10 CANNETE' unicolore cm.50x70

2208/1 ● Rosso

2208/2 ● Giallo

2208/3 ● Verde

2208/4 ● Blu

2208/5 ● Avana

Bordo ondulato

Il classico cartone ondulato nella nuova versione in rotolo pretagliato dall'effetto "onda".
Ideale per scenografie!

Rotolo cm.6x15 metri gr.170
(composta da due strisce da mt.7,5)

- 06276** ● Rosso
- 06277** ● Blu
- 06278** ● Verde
- 06279** ● Giallo
- 06280** ○ Bianco
- 12151/1** ● Oro
- 12151/2** ● Argento



Plastica ondulata

Un materiale duttile e versatile con cui è possibile creare originalissimi lavoretti. Facile da tagliare e da piegare, la plastica ondulata (detta anche polionda) è adatta per lavori didattici, scenografie, cartellonistica, grafica, modellismo, ecc.
SPECIALE PER LAVORI 3D SUPER RESISTENTI

UR1215
cm.50x70 mm.2,2 (10 cartoncini)
colori assortiti

04972
cm.70x100 mm.3 (10 cartoncini)
colore bianco

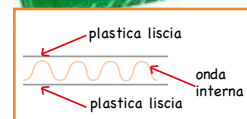

Carton BLOCK

Cartone spessorato color avana da un lato e colorato dall'altro.

5 CARTONI BLOCK
cm.50x70 mm.4

conf./monocolore

- 10861** ● Rosso
- 10862** ● Verde
- 10863** ● Blu
- 10864** ● Giallo
- 10865** ● Arancio

10860
5 cartoni cm.50x70 colori assortiti

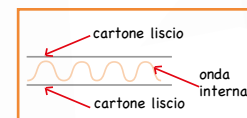

Portacarte

Portacarte e cartoncini verticali da fissare alle pareti. Realizzati in resistente metallo antiruggine. Ottima soluzione salvaspazio per ogni ambiente. Ideale anche per riporre libretti, quaderni, ecc.

08358

portacarte formato A5 (cm.14,8x21)
9 vani cm.17x9x75 h
Può contenere fino a 1200 fogli da 80 gr.

08357

portacarte formato A4 (cm.21x29,7)
6 vani cm.22x9x75 h
Può contenere fino a 900 fogli da 80 gr.

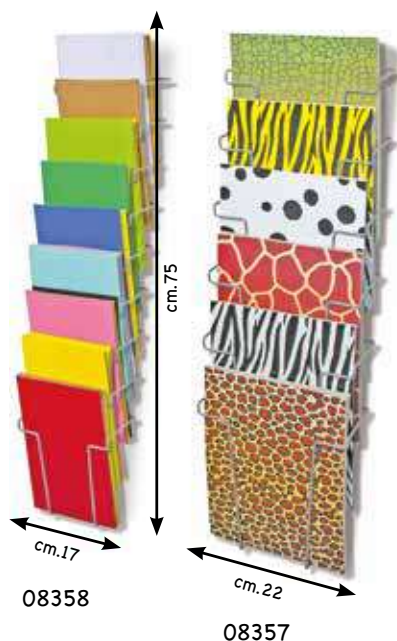

BANDA PORTADISEGNI IN LEGNO E SUGHERO

10365 - cm.100x7 - spessore mm.12

10366 - cm.150x7 - spessore mm.12



PORTACARTE IN ACCIAIO VERNICIATO

08646

portacarte a parete formato A4 (15 vani) cm.118x45 h
Può contenere fino a 2200 fogli di carta gr.80

FACILE
DA
SPOSTARE



09723

mobile/carrello per far asciugare fogli e disegni.
17 ripiani in tondino di acciaio cm.37x35x66 h

Mobili per carte e cartoncini



08708

mobile in MDF per far asciugare fogli e disegni 10 ripiani in tondino di acciaio cm.43x55x100 h (fornito montato)



MOBILI
DOPPIO
USO

08707

mobile per carta e cartoncini con 11 ripiani in legno cm.43x55x100 h (fornito montato)



08709

ripiano portacarta in legno cm.41x52 - spazio utile cm.7 h



08710

ripiano asciugafogli in acciaio cm.41x52

PER
FOGLI CM.
50x70



07789

mobile (in legno) con 10 ripiani. Può contenere fino a 300 fogli per ripiano di carta gr.80 cm.50x70
Dimensioni: cm.78x45x100 h (fornito montato)

PER
FOGLI CM.
70x100



07971

mobile (in legno) con 10 ripiani. Può contenere fino a 300 fogli per ripiano di carta gr.80 cm.70x100
Dimensioni mobile: cm.73x109x96 h (fornito montato)

Valigette portadisegni

Pratiche, leggere, resistenti.
Nella versione bianca le maniglie e le chiusure sono assortite in vari colori.

PRATICA
LEGGERA E
SICURA!

DISPONIBILI IN 2 SPESSORI

12099 - cm.27x37x5 - bianca

12100 - cm.27x37x8 - bianca

12101 - cm.27x37x5 - nera

12102 - cm.37x52x3 - nera

12103 - cm.52x72x3 - nera

12104 - cm.70x100x3 - nera



Tubi telescopici

844x6

6 tracolle per tubi telescopici
(per art.09960 e 842T/100)



09960

tubo \varnothing cm.6,5 - colore nero
(per fogli da cm.45 a cm.80)



842T/100

tubo \varnothing cm.10,5 - colore nero
(per fogli da cm.65 a cm.105)

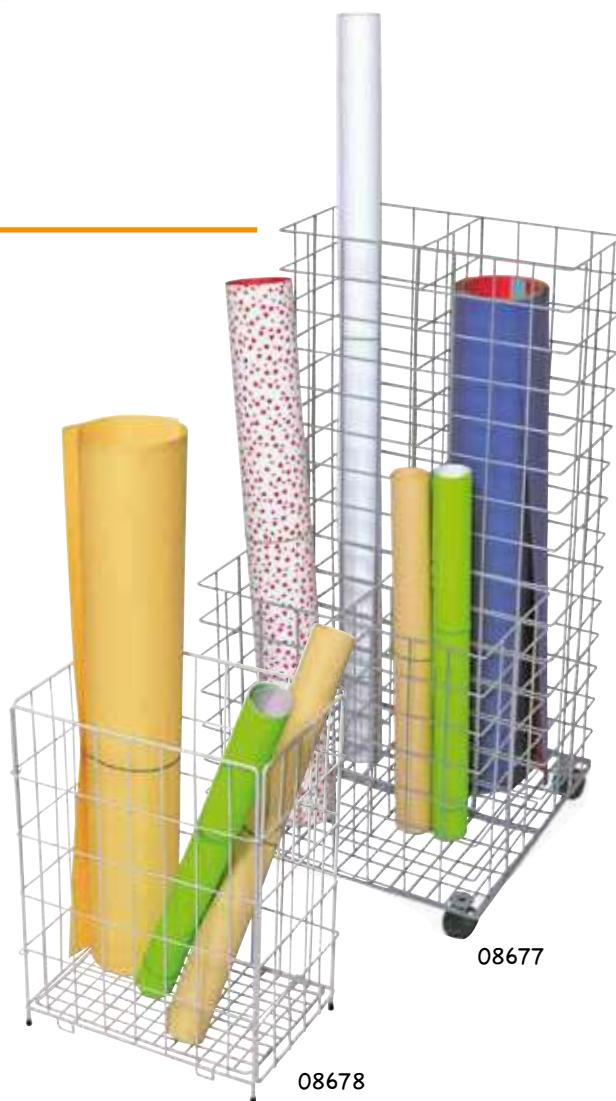

08677

08678

CESTE PORTAROTOLI IN METALLO

08678 - cm.22x30x43 h

08677 - cm.39x39x82 h
(suddivisa in 4 scomparti)

Fustelle



SAGOMA

16 mm.

OFFERTA SPECIALE
PER ESAURIMENTO

● VIA21/12
mini fustella singola mm.16



VIA21/12
treno

VIA21/1...
mini fustella singola mm.16



VIA21/1
trifoglio



VIA21/2
tulipano



VIA21/3
albero



VIA21/4
zampa



VIA21/5
cuore



VIA21/6
stella



VIA21/7
delfino



VIA21/8
gatto seduto



VIA21/9
orso



VIA21/11
angelo



VIA21/13
campana



VIA21/14
farfalla



VIA21/15
Babbo
Natale



VIA21/16
luna



VIA21/17
fiocco
di neve



VIA21/18
pupazzo
di neve



VIA21/19
pulcino



VIA21/20
cuoricini



VIA21/21
margherita



VIA21/22
fiore



VIA21/23
sole



VIA21/24
albero
Natale



VIA21/25
angelo



VIA21/26
carrozzina
neonato



VIA21/27
cerchio



SAGOMA

25 mm.

04826...
mini fustella singola mm.25



04826
stella



04827
cuore



04829
nota
musicale



04830
foglia



04831
mela



04832
margherita



04833
sole



04834
angelo



07887
bambino



07888
bambina



10421
albero



10422
orso



10423
fiocco di neve



10424
mano



10425
campana



10426
colomba



10427
cuoricini



10642
farfalla



10974
angelo



10975
stella cometa



10976
quadrifoglio



10977
stella
stilizzata



10978
farfalla
stilizzata



10979
margherita
stilizzata



11480
cerchio



11481
quadrato



11482
ovale



11483
cerchio
merlato



11484
ovale
merlato



SAGOMA

38 mm.

10980/1...
mini fustella singola mm.38



10980/1
stella



10980/2
angelo



10980/3
fiocco di neve



10980/4
albero
Natale



10980/5
cuore
freestyle



10980/6
cuore



10980/7
fiore



10980/8
margherita



10980/9
farfalla



10980/10
tulipano



10980/11
cerchio



10980/12
ovale



10980/13
cerchio
merlato



SAGOMA

50 mm.

11162/1...
mini fustella singola mm.50



11162/1
stella



11162/2
fiocco
di neve



11162/3
cuore



11162/4
farfalla



11162/5
cerchio



11162/6
tag



11162/7
ovale

Fustelle per angoli

SAGOMA
PER ANGOLI

25
mm.



10995/1...
fustella per angoli mm.25



10995/1
fiore



10995/2
foglie



10995/3
ornamento



10995/4
cuoricini



10995/5
fiocco
di neve

SAGOMA
PER ANGOLI

38
mm.



11168/1 e 11168/2
fustella per angoli mm.38

● **VL112**
fustella "Western" per angoli mm.12



11168/1
fiore



11168/2
cuori



VL112
western

SAGOMA
PER BORDI

25
mm.



11170/1...
fustella per bordi mm.25

Funzione di allineamento speciale
per la punzonatura continua.



11170/1
fiocchi di neve

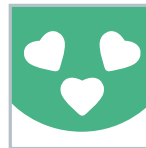

11170/2
cuoricini



11170/3
pizzo
deco

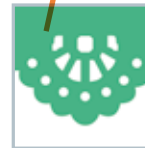

11170/4
pizzo
san gallo



11170/5
stelle

Fustelle per bordi

SAGOMA
PER BORDI MAXI

14x45
mm.



11175/1 a 11175/5
fustella MAXI per bordi mm.14x45



11175/3 - romantic



11175/1 - rococo'



11175/4 - barocco



11175/2 - foglie



11175/5 - cuori

Macchina fustellatrice



“La Little” permette di tagliare ed embossare, attraverso le fustelle, forme di ogni genere e di vari materiali, tra cui carta, cartoncino e Gomma Crepp. Si appoggia il materiale da tagliare sulla fustella e sopra e sotto si collocano le placche trasparenti da taglio comprese nel kit. Si inserisce tutto nell’apertura della macchina e si gira la manovella. All’ uscita si estraggono le formine ritagliate. Ideale per lo scrapbooking, per creare inviti, biglietti d’auguri...

TAGLIA:

Carta

Cartoncino

Gomma Crepp 1/2 mm



base da taglio

12112

cm.16,5x7,8x3

12113

cm.16,5x7,8x5

12111

macchina per fustellare/embossare

cm.18,5x9,5x13,5

da 12128/01 a .../05

da 12128/06 a .../13

da 12128/14 a .../18

da 12128/19 a .../20

da 12128/21 a .../23



12128/01
45x32 mm



12128/02
58x32 mm



12128/03
48x34 mm



12128/04
61x30 mm



12128/05
lettera H:
11x12 mm



12128/06
50x48 mm



12128/07
numero 1:
9,6x21 mm



12128/08
palloncino:
21x29 mm



12128/09
74x48 mm



12128/10
48x34 mm



12128/11
49x29 mm



12128/12
nuvoletta:
34x20 mm



12128/13
80x57 mm



12128/14
margherita:
19x19 mm



12128/15
53x63 mm



12128/16
foglia:
28x23 mm



12128/17
orso:
42x44 mm



12128/18
35x75 mm



12128/19
cuore:
48x41 mm



12128/20
stella:
55x58 mm



12128/21
fiocco:
45x45 mm



12128/22
farfalle:
83x68 mm

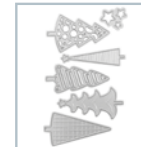

12128/23
alberi:
45x72 mm

Base per piegature

"Blues" è lo strumento indispensabile per ogni lavoro di scrapbooking! Perfetto per realizzare buste, biglietti d'auguri, inviti... Non servono calcoli e misurazioni... Tracciare le piegature è facilissimo con la pieghetta inclusa nella confezione.



12362
base per piegature cm.14x18
+ pieghetta + fustella angolare

FUSTELLA
ANGOLARE
INCLUSA



12363
base per piegature cm.30,5x30,5
+ righello e pieghetta

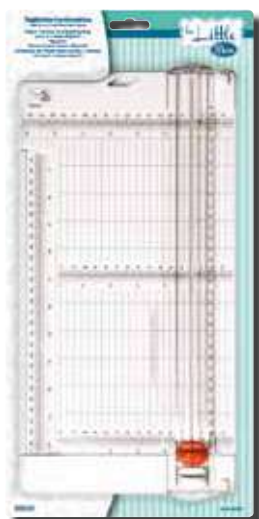

12364
taglierina-cordonatrice
cm.15,2x30,5



12365
lama per taglierina (2 pezzi)

12366
lama + cordonatore per taglierina (2 pezzi)



Pressa per timbri

Pressa per timbri, essenziale per ottenere stampe precise e definite. Consente di realizzare lavori di stampa multistrato. Stampe uniformi e dettagliate!

- Ideale per timbri trasparenti e in gomma/silicone
- Precisa e facile da usare



12368
pieghette per carta
2 pezzi



12361
pressa per timbri cm.18,5x9,5x13,5

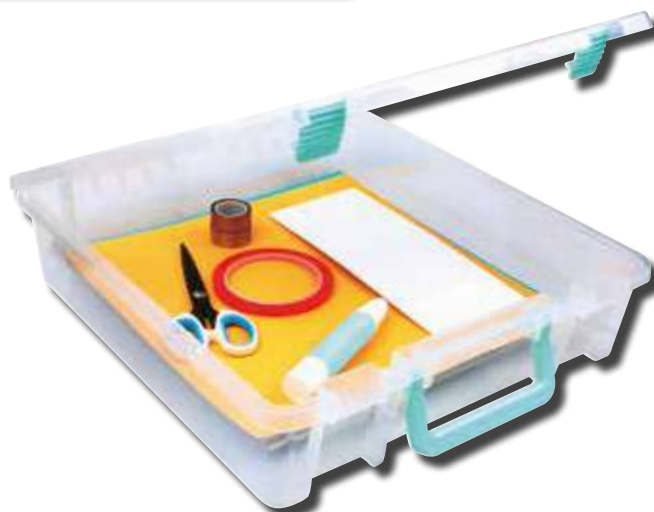

12367
valigetta scrapbooking con manico
cm.38,8x35,5x8,9 h



Laboratorio di pittura

La pittura è un ottimo modo per esprimersi e comunicare emotivamente.

Fino a una certa età i bambini non sono in grado di parlare o esprimersi verbalmente o attraverso la parola... Ecco perché la pittura è per loro un modo per esprimere i propri sentimenti e pensieri.

Ecco a voi le nostre proposte per colorare ogni oggetto e superficie: tempera, pastelli, matite colorate, acquerelli e tutti gli strumenti necessari per trasformare immaginazione e creatività in vere e proprie opere d'arte.

46 Colore

70 Pennelli

93 Tele per pittura

95 Tavolozze

Pennarelli

- super lavabili
- colori brillanti
- cappuccio ventilato
- atossici

Samba



12732/12

pennarelli punta fine
super lavabili - scatola pz.12

12732/24

pennarelli punta fine
super lavabili - scatola pz.24

12732/96

pennarelli punta fine
super lavabili - barattolo pz.96



JUMBO

12740/12

Pennarelli JUMBO punta grossa
super lavabili - scatola pz.12

12740/24

Pennarelli JUMBO punta grossa
super lavabili - scatola pz.24

12740/48

Pennarelli JUMBO punta grossa
super lavabili - barattolo pz.48



Pennarelli Jumbo

- Colori vivaci e brillanti
- Punta resistente e duratura
- Tappo di sicurezza
- Maxi fusto

Serie di pennarelli indicata per i più piccoli!

NOVITA'

KR972319

scatola 12 pennarelli JUMBO
colori assortiti



- Colori vivaci e brillanti
- Punta conica resistente e duratura
- Tappo di sicurezza
- 2 tratti di scrittura
- Maxi fusto

PUNTA
CONICA
2
TRATTI



NOVITA'

KR972320

scatola 12 pennarelli JUMBO
colori assortiti



"Io coloro" set prima infanzia

Il primo set per colorare!
Comprende 8 pastelli a cera,
6 pennarelli JUMBO e un
poster gigante predisegnato

cm.20,5x22x5



NOVITA'

KR972321

valigetta set 16 pezzi

Contenuto:



1 POSTER DA COLORARE



VALIGETTA
PRATICA E
FUNZIONALE!

6 PENNARELLI JUMBO

- Colori vivaci e brillanti
- Punta conica resistente e duratura
- Tappo di sicurezza
- 2 tratti di scrittura
- Maxi fusto



8 PASTELLI A CERA

- Atossici
- Tratto morbido e uniforme
- Ricchi di pigmenti, colori vivaci e brillanti
- Fusto spesso e resistente



Pennarelli Stamperelli

Con doppia punta in feltro, una conica per tracciare linee grosse e fini e una a stampino nella parte superiore del corpo. Inchiostro a base acqua, atossico.

2 in 1

UN LATO
PENNARELLO
UN LATO
STAMPINO



KR972350

scatola 12 pennarelli
colori assortiti

Pennarelli Baby Tip

Marcatore punta tonda anti schiacciamento, a prova di bambino. Inchiostro a base acqua, atossico.



PUNTA ANTI-SCHIACCIAMENTO



KR972347

scatola 12 pennarelli
colori assortiti

Pennarelli per tessuti



NO GLUTINE
CASEINA E UOVA

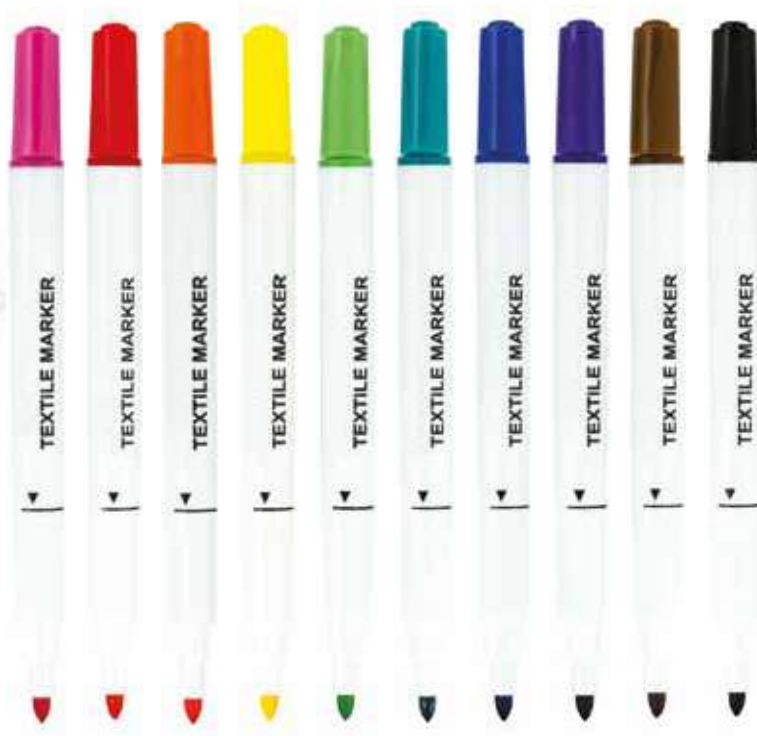

C2739/6

busta 6 marker per tessuti ml.35 colori assortiti

C2739/10

busta 10 marker per tessuti ml.35 colori assortiti

Marker ad inchiostro pigmentato a base d'acqua, resistente alla luce, scrive su tutti i tessuti. Resistente ai lavaggi fino a 60°.

Marker per porcellana-terracotta



MARKER PER PORCELLANA PUNTA MM.2

- 06980** - nero
- 06981** - rosso
- 06982** - blu
- 06983** - verde
- 06984** - giallo
- 06985** - marrone



Marker PER TERRACOTTA punta mm.4

- 06970** - nero
- 06971** - rosso
- 06972** - blu
- 06973** - verde
- 06974** - giallo
- 06975** - bianco



Gesso liquido

Gesso liquido a base acqua. Adatto per scrivere su finestre, lavagne nere e tante altre superfici. L'inchiostro è permanente su carta e altri materiali porosi, mentre su superfici non porose può essere cancellato con un panno.

da 04180 a 04185

pennarello gesso, punta 2-5 mm

- 04180** Bianco
- 04181** Blu
- 04182** Verde
- 04183** Giallo
- 04184** Arancio
- 04185** Rosa



Gesso stick

- Punta ø mm.9,5
- Utilizzabile su qualsiasi superficie
- Si cancella facilmente con uno straccio o un panno umido
- Tratto scorrevole e morbido
- Non tossico

- 12757/1** - pennarello bianco
- 12757/2** - pennarello oro
- 12757/3** - pennarello argento
- 12757/A3** - set 3 pennarelli
(1 bianco + 2 colori fluo)



12757/A3

12757/1

12757/2

12757/3



Marker cancellabili



12750

marker cancellabili colori assortiti
scatola pz. 12 (punta tonda)



- TRATTO 1-4 MM
- CANCELLABILE
- ASCIUGA RAPIDAMENTE

06135 - blu

06136 - nero

06137 - rosso

06138 - verde

07763 - busta 4 marker colori assortiti

Marker indelebili



12751

marker indelebili colori assortiti
scatola pz. 12 (punta tonda)

10 MARKER PUNTA TONDA

TRATTO DA MM.1 A 3

12040/1x10 - nero

12040/2x10 - blu

12040/3x10 - rosso

12040/4x10 - verde

NOVITA'

10 MARKER PUNTA SCALPELLO

TRATTO DA MM.1 A 5

11682/1x10 - nero

11682/2x10 - blu

11682/3x10 - rosso

11682/4x10 - verde

NOVITA'

12 MARKER PUNTA SCALPELLO

11679/1x10 - 2 marker nero

11679/2x10 - 2 marker blu



Matite colorate

Mambo

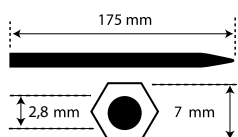

MATITE COLORATE
CON CORPO IN LEGNO VERNICIATO

C3652 - scatola 12 matite colori assortiti

09682 - scatola 24 matite colori assortiti

09683 - scatola 36 matite colori assortiti

C3616/60 - barattolo 60 matite colori assortiti



C3652



C3616/60

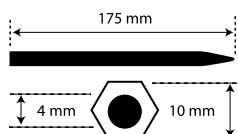

JUMBO

MAXI MATITONI COLORATI

CON CORPO IN LEGNO VERNICIATO

09819 - scatola 12 matitoni colori assortiti

09818 - barattolo 60 matitoni colori assortiti



09819



09818

Matite colorate JUMBO

- Morbida mina da mm.5, ricca di pigmenti
- Fusto triangolare in legno, facile da impugnare
- Colori vivaci e brillanti



Fusto triangolare



NOVITA'

KR972314

scatola 12 matitoni colori assortiti

Matite "metalcolor"

- colori metallici
- mina morbida 3mm con polvere metallica
- facile da temperare
- design elegante con legno nero
- spazio per il nome



METAL
BLACK WOOD

6
PEZZI



KR971869

set 6 matite metalcolor
(6 colori assortiti)



Matite "fluo color"

- colori fluorescenti
- mina morbida 3mm con polvere metallica
- facile da temperare
- design elegante con legno nero
- spazio per il nome



NEON
BLACK WOOD

6
PEZZI



KR971870

set 6 matite fluo color
(6 colori assortiti)



Matite "pastel color"

- colori pastello
- mina morbida 3mm
- facile da temperare
- design elegante
- spazio per il nome



PASTEL

6
PEZZI



KR971871

set 6 matite pastello
(6 colori assortiti)



Matite "rainbow"

- 4 matite in 1
- sezione triangolare
- formato JUMBO

KR972102

set 2 matite "rainbow"



JUMBO



Matite colorate in legno

Pastelli colorati con corpo in legno naturale non verniciato.

dimensioni cm.17,5

C3616H/12

scatola 12 matite colori assortiti

C3616N/60

barattolo 60 matite colori assortiti



Matite acquerellabili

Matita per artisti di qualità, intensamente cromatica. In legno di cedro, acquerellabile. La mina piacevolmente morbida consente un'applicazione uniformemente coprente del colore. I colori sono brillanti, intensi e fotostabili. Lavorando a secco si hanno gli stessi risultati ottenibili con le normali matite colorate. Applicando l'acqua, con pennello o spugna, si ottengono sfumature ad acquerello fluidamente morbide.

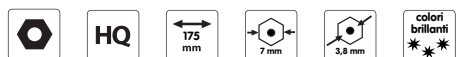

K2139N

scatola 12 matite colori assortiti

K2140N

scatola 24 matite colori assortiti

K2141N

scatola 36 matite colori assortiti

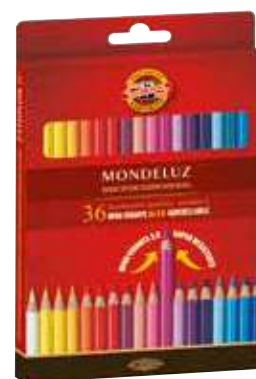

dimensioni cm.17,5

Matita rosso / blu



C3423/12

12 matite rosso/blu esagonale
cm.18x0,9 ø

CON AFFILAMINE



C4010

scatola 12 portamine con mine
colori assortiti + affilamine



scatola 12 matite TUTTA-MINA nero

C8911/2B - gradazione 2B

C8911/HB - gradazione HB

Matite grafite

pag.269-271
temperamatite e gomme



cm.18x0,8 ø corpo giallo

C1602/12

scatola 12 matite temperate HB esagonali

C1380/12

scatola 12 matite HB esagonali con gomma

C1602/60

barattolo 60 matite temperate HB esagonali

C1380/60

barattolo 60 matite HB esagonali con gomma



C1602/12

C1602/60

cm.18x0,8 ø corpo giallo



C1770/E

PACK SCUOLA 72 matite

contiene:

2B (12 pz.)

B (12 pz.)

HB (24 pz.)

F (12 pz.)

H (12 pz.)

Scatola 12 matite esagonali

C1770/2B - gradazioni: 2B

C1770/B - gradazioni: B

C1770/F - gradazioni: F

C1770/H - gradazioni: H

C1770/HB - gradazioni: HB



Impugnature

- Un aiuto per imparare a scrivere
- Design ergonomico
- Grip soffice e antiscivolo
- Perfetta anche per mancini



11430

impugnatura per matite
set 10 pezzi



KR971539

set 2 pezzi

KR971540

PACK SCUOLA 48 pezzi



11448

impugnatura triangolare
per matite set 6 pezzi

Pastelli a cera

- super lavabili
- tratto morbido
- colori brillanti
- atossici



(ø 8x90 mm)

PASTELLI A CERA

3450/12 - scatola 12 pastelli assortiti

3450/24 - scatola 24 pastelli assortiti

3450/64 - scatola 64 pastelli assortiti

3450/48B - barattolo 48 pastelli assortiti



(ø 11x100 mm)

JUMBO

PASTELLI A CERA JUMBO

09825

scatola 12 pastelli JUMBO assortiti

09826

barattolo 50 pastelli JUMBO assortiti



Pastelli a cera in legno

Serie di pennarelli indicata per i più piccoli!

- pastelli a cera 3 in 1
- maxi fusto in legno
- colori vivaci, solubili in acqua



NOVITA'

KR972328

scatola 6 pastelli JUMBO colori assortiti



JUMBO



Pastelli a cera d'api

- Formula naturale a base di cera d'api
- Atossici
- Tratto morbido e uniforme
- Ricchi di pigmenti, colori vivaci e brillanti
- Fusto spesso e resistente

NOVITA'

KR972338

scatola 12 pastelli colori assortiti

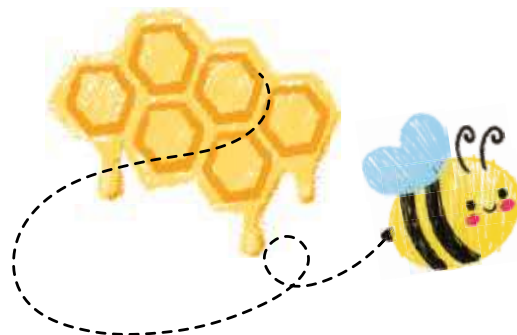

Pastelli a cera "Rocket"

Serie di pennarelli indicata per i più piccoli!

- 6 pastelli impilabili per creare un divertente missile
- Facili da impugnare e utilizzare
- Combinazione di colori primari



NOVITA'

KR972322

scatola 6 pastelli colori assortiti



Pastelli a cera "Rocket"

- 6 pastelli a cera da mettere sulle dita
- Colori vivaci e brillanti
- Atossici



NOVITA'

KR972331

scatola 6 pastelli colori assortiti



COLORA
SENZA
SPORCARTI!



Pastelloni a cera



11454 - barattolo 6 pastelloni assortiti

11455 - set 6 pastelloni di ricambio

Pastelli a olio

PRODOTTI DI PRIMA QUALITÀ, composti da pigmenti ed olii minerali molto pregiati. Questi finissimi pastelli sono tutti miscelabili fra loro, possiedono ottima resistenza alla luce e permettono di ottenere colori brillanti e intensi. Atossici.



(\varnothing 8,3x60 mm)



(\varnothing 11x70 mm)

PASTELLI A OLIO "MINI ARTIST"

MY/MOP12S - scatola 12 pastelli assortiti

MY/MOP24S - scatola 25 pastelli assortiti

Una linea di pastelli a olio studiata per i più piccoli. Atossici.

PASTELLI A OLIO

MY/MOP12 - scatola 12 pastelli assortiti

MY/MOP24 - scatola 24 pastelli assortiti

MY/MOP48 - scatola 48 pastelli assortiti



(\varnothing 17x70 mm)



(\varnothing 11x70 mm)

PASTELLI A OLIO SEMI-JUMBO

06559 - scatola 12 pastelli assortiti

PASTELLI A OLIO METAL

06127
scatola 12 pastelli METALLIZZATI assortiti

Gessi

Gessi da pavimento

Gessi colorati di grandi dimensioni da pavimento. Ideali per le manine dei bambini più piccoli.



20
PEZZI



12059
20 gessi JUMBO da pavimento
cm.10x2,5x2,2 colori assortiti

Gessi fantasia da pavimento



12536
barattolo 15 gessi JUMBO da pavimento
fantasie e colori assortiti



15
PEZZI

Gesso spray

Ideale per superfici vaste, consente di realizzare in modo veloce e pulito coloratissime scenografie, sfondi, cartelloni, mantenendo l'effetto gesso. Permanente su carta e altri materiali porosi, mentre su superfici non porose può essere cancellato con un panno.

- Bombola ml.200
- 07384** - verde
- 07385** - blu
- 07386** - arancio



pag.49
gesso liquido

Gessi



ALTA QUALITÀ
AL MIGLIOR
PREZZO



TIPO
PROFESSIONALE



(ø 10x81 mm circa)

Compatti e molto resistenti, sono cancellabili e non stridono. Tratto intenso, antipolvere. Atossici.

GESSI TONDI ANTIPOLVERE PER LAVAGNA

12508 - scatola 12 gessi colori assortiti

12509 - scatola 12 gessi bianchi

MY/W100 - scatola 100 gessi bianchi

MY/R100 - scatola 100 gessi rossi

MY/CA100 - scatola 100 gessi colori assortiti



(ø 10x81 mm circa)

GESSI TONDI ANTIPOLVERE ALTA QUALITA'

● **07761** - scatola 100 gessi bianchi

● **07762** - scatola 100 gessi colori assortiti

Portagessi

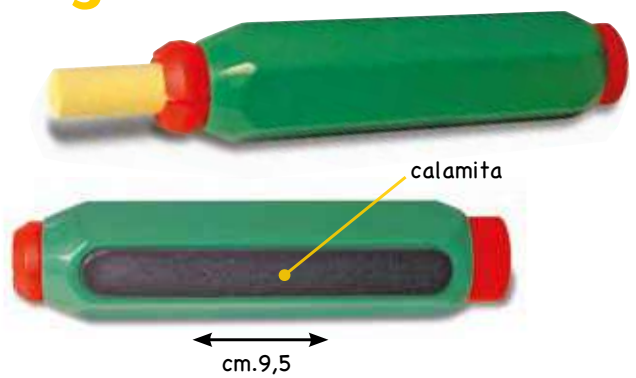

06128

portagessi/pastelli con calamita - cm.9,5
(gessi da ø minimo mm.7 a ø massimo cm.1,3)

Adattabile a qualunque tipo di gesso e pastello.
Dotato di calamita per attaccarlo alle lavagne magnetiche.



pag.311
lavagne nere

Gessi JUMBO

- Maxi fusto, facile da impugnare
- Colori vividi
- Lavabili
- Antipolvere

NOVITA'

KR972325

scatola 6 gessi JUMBO colori assortiti

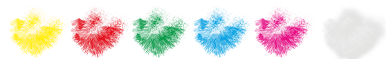

Gessi quadrati policromi

Gessi policromi dal tratto scorrevole e morbido. Colori intensi e brillanti, miscelabili tra loro e sovrapponibili. Perfetti per realizzare disegni su carta e cartoncini, su cui sarà possibile ottenere sfumature e giochi di colore con l'aiuto di uno sfumino o delle dita. Indicati anche per essere utilizzati su lavagne e sull'asfalto. Per conservare nel tempo i disegni a gesso consigliamo di utilizzare uno spray fissativo.



(10x10x64 mm circa)

GESI QUADRATI ANTIPOLVERE

MY/MCP12 - scatola 12 gessi colori assortiti

MY/MCP24 - scatola 24 gessi colori assortiti

MY/MCP48 - scatola 48 gessi colori assortiti



MY/MCP24

Gessi quadrati



C112008

scatola 12 gessi quadrati cm.1x1x10 colori assortiti



C111002

scatola 100 gessi quadrati
cm.1,2x1,2x10 colore bianco

Tempera



11691/...



PF550/...



08808/...

Colori a tempera

Colori a tempera a base acqua, completamente atossici. Studiati per essere utilizzati in grandi quantità anche dai bambini, direttamente dal flacone.

Tempera **ML 250**

- 11691/01 Bianco
- 11691/26 Giallo primario
- 11691/08 Rosso scarlatto
- 11691/14 Verde brillante
- 11691/21 Blu/Cyan
- 11691/02 Nero

11691/A

confezione 6 flaconi ml.250
colori assortiti

Tempera **ML 500**

- PF550/01 Bianco
- PF550/26 Giallo primario
- PF550/17 Arancio
- PF550/07 Rosa
- PF550/25 Magenta
- PF550/06 Carminio
- PF550/29 Rosso scarlatto
- PF550/12 Verde medio
- PF550/14 Verde brillante
- PF550/21 Blu/Cyan
- PF550/10 Blu oltremare
- PF550/30 Violetto
- PF550/28 Marrone
- PF550/02 Nero

- PF550/40 Oro
- PF550/41 Argento

PF550/A

confezione 6 flaconi ml.500
colori assortiti

Tempera **ML 1000**

- 08808/01 Bianco
- 08808/26 Giallo primario
- 08808/17 Arancio
- 08808/07 Rosa
- 08808/25 Magenta
- 08808/06 Rosso vermiglio
- 08808/08 Rosso scarlatto
- 08808/12 Verde medio
- 08808/14 Verde brillante
- 08808/21 Blu/Cyan
- 08808/10 Blu oltremare
- 08808/11 Violetto
- 08808/28 Marrone
- 08808/02 Nero

- 08808/40 Oro
- 08808/41 Argento

09423

confezione 6 flaconi ml.1000
colori assortiti



Tempera GLITTER **ML 250**

- 08992/1 Oro
- 08992/2 Argento
- 08992/5 Rosso



Tempera PERLA **ML 250**

- 08998/1 Oro
- 08998/2 Argento

Tempera Acrilica

**Brillante, impermeabile
e indelebile.
Per ogni superficie!**

Tempera Acrilica

ML
250

| | | |
|----------|---|-----------------|
| 11700/01 |  | Bianco |
| 11700/26 |  | Giallo primario |
| 11700/17 |  | Arancio |
| 11700/07 |  | Rosa |
| 11700/25 |  | Magenta |
| 11700/06 |  | Vermiglio |
| 11700/08 |  | Rosso scarlatto |
| 11700/12 |  | Verde medio |
| 11700/14 |  | Verde brillante |
| 11700/21 |  | Cyan |
| 11700/10 |  | Blu oltremare |
| 11700/11 |  | Violetto |
| 11700/28 |  | Marrone |
| 11700/02 |  | Nero |

| | | |
|----------|---|---------|
| 11700/40 |  | Oro |
| 11700/41 |  | Argento |
| 11700/42 |  | Rame |
| 11700/43 |  | Bronzo |

11700/A
confezione 6 flaconi assortiti ml.250



NOVITA'

12945

scatola 6 acrilici (tubo ml.100)
colori della pelle (art.11535/201, 11535/210,
11535/601, 11535/676, 11535/684, 11535/690)

I colori della pelle



Colori a dita

pag.86
grembiule
per bambini

PRIVO DI
✓ glutine
✓ caseina
✓ uova

Colori a dita intensi, brillanti e coprenti, adatti soprattutto per uso didattico nelle scuole materne, in quanto permettono ai bambini di dare libero sfogo alla creatività. Lavabili e atossici, i colori Deco Dita asciugano con rapidità e sono miscelabili tra loro.

Colori a dita **ML 150**

- 1637/01** Bianco
- 1637/26** Giallo primario
- 1637/06** Carminio
- 1637/10** Blu oltremare
- 1637/12** Verde medio
- 1637/02** Nero

1637/A
conf. 6 barattoli assortiti
ml.150

Colori a dita **ML 500**

- 10242** Bianco
- 10243** Giallo primario
- 10244** Rosso scarlatto
- 10245** Verde
- 10246** Blu
- 10247** Nero

10241
conf. 6 barattoli assortiti
ml.500



Flaconi

Flacone con serbatoio ricaricabile con tempere, acrilici, colori per tessuti, ecc...
Ideale per colorare grandi superfici e scritte.



10239
5 pompette per flaconi tempera



UTILIZZABILE
con tempera
liquida



12317
confezione 10 flaconi ml.50

Colori a dita

Nessun problema se i bambini si sporcano con questi colori... Si lavano facilmente! Atossici, sicuri, conformi agli standard europei sulla sicurezza. Colori vividi e brillanti che non sbiadiscono facilmente, possono essere usati su svariate superfici.

- Super lavabili
- Atossici
- Colori super brillanti e miscelabili



ML
60

NOVITA'

KR972346

scatola 6 colori a dita ml.60

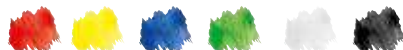

NOVITA'

KR972330

scatola 6 colori a dita ml.100



ML
100



Impilabili, facili da trasportare. Apertura facilitata.

Set pittura a dita

NOVITA'

KR972324

set completo di:

- 6 colori a dita ml.25
- 10 fogli di carta per pittura cm.22x19
- 1 tavolozza



66 Laboratorio di pittura

DecoStick

Un nuovo modo di dipingere senza usare i pennelli! Tempera solida in stick, facilmente impugnabili anche dai più piccoli. La grande punta consente ai bambini di disegnare e dipingere con facilità, sviluppando le proprie capacità espressive e motorie. Colori brillanti e coprenti che asciugano rapidamente, senza lasciare sbavature. Facilmente lavabili con acqua e sapone, atossici, non seccano. Gli stick di tempera solida sono perfetti per dipingere su svariate superfici: carta, legno, vetro, tessuti, pietra...



NOVITA'

12931

12 stick tempera solida (gr.10 cad)



Acquerelli "Ufo"

Solubili in acqua e facilmente lavabili. L'alto contenuto di pigmenti garantisce tinte brillanti e resistenti. Pastiglie in formato maxi, per soddisfare le esigenze dei bambini.

NOVITA'

KR972323

custodia/tavolozza 6 maxi pastiglie di acquerelli
Ø mm.40 + 1 maxi pennello

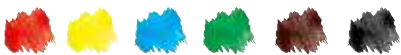

Acquerelli

NOVITA'

KR972348

6 maxi pastiglie di acquerelli
Ø mm.40 + 1 pennello

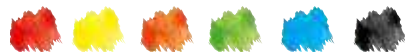









Tavolozze con maxi pastiglioni acquerellabili

Acquerelli di qualità eccezionale a base di pigmenti selezionati:

- elevata resistenza alla luce e ottima resa
- coprenti
- ottima aderenza a tutti i fondi
- effetto vellutato una volta asciutti
- atossici

4 tavolozze cm.10x7,5 +
pastiglione ø cm.5,7x1,9 h



| | | |
|----------------|---|---------|
| 12575x4 |  | Rosso |
| 12576x4 |  | Giallo |
| 12577x4 |  | Verde |
| 12578x4 |  | Blu |
| 12579x4 |  | Marrone |
| 12580x4 |  | Nero |
| 12581x4 |  | Bianco |
| 12582x4 |  | Arancio |



Pastiglione unicolore
ø cm.5,7x1,9 h

| | | |
|--------------|---|---------|
| 07530 |  | Rosso |
| 07531 |  | Giallo |
| 07532 |  | Verde |
| 07533 |  | Blu |
| 07534 |  | Marrone |
| 07535 |  | Nero |
| 09101 |  | Bianco |
| 09102 |  | Arancio |

MAXI acquerelli

Acquerelli di alta qualità:

- elevata resistenza alla luce
- coprenti
- ottima aderenza a tutti i fondi
- effetto vellutato una volta asciutti
- atossici



12574
tavolozza con 8 pastiglioni acquerellabili
Dimensioni tavolozza: cm.33x14
Dimensioni pastiglia: ø cm.5,7x1,9 h



06017
tavolozza con 6 pastiglioni acquerellabili
+ 1 pennello. Confezionata in scatola
tavolozza: cm.15x22
pastiglia: ø cm.5,7x1,9 h



12573
tavolozza con 6 pastiglioni acquerellabili
tavolozza: cm.21x20
pastiglia: ø cm.5,7x1,9 h

Acquerelli



Realizzati con lo scopo di garantire un ottimo rapporto qualità-prezzo, questi acquerelli sono adatti per uso scolastico, hobbistico e dilettantistico.



∅ cm.2,3

C90065

astuccio tondo 12 acquerelli
astuccio: ∅ cm.8,5
pasticca: ∅ cm.2,3

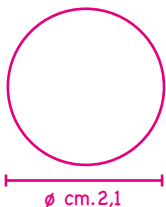

∅ cm.2,1

11747

12 acquerelli + 1 pennello
pasticca: ∅ cm.2,1



∅ cm.2,8

10880

astuccio/valigetta 12 acquerelli
+ 1 pennello
∅ pasticca: cm.2,8



∅ cm.2,8

L94621

21 pasticche tonde (∅ cm.2,8)
+ 1 pennello - astuccio: cm.12x25



∅ cm.3

11745

24 acquerelli + 2 pennelli
pasticca: ∅ cm.3



11744

12 acquerelli + 1 pennello
pasticca: ∅ cm.3



cm.4

06023

astuccio 8 pastiglioni tempera
giganti ∅ cm.4 + 1 pennello
dimensioni: cm.11,5x21
Il coperchio diventa una tavolozza

11746

10 acquerelli + 1 pennello
pasticca: ∅ cm.4

Pennelloni

- Maxi fusto ergonomico, disegnato appositamente per i bambini
- Facile da impugnare
- Struttura antiscivolo
- Setole sintetiche, facili da lavare e molto durature

Piatto



Tondo



A punta



NOVITA'

KR972329

blister 3 pennelloni maxi fusto (a punta, tondo e piatto)



L2M

blister 2 pennelli Jumbo lunghezza cm.19 ø setole cm.1

06153

barattolo 24 pennelli Jumbo lunghezza cm.19 ø setole cm.1



05448

barattolo 20 pennelli piatti
cm.1x19 manico in plastica

L824

barattolo 72 pennelli tondi
lunghezza cm.17,5



04143

barattolo 20 pennelli tondi
ø cm.1x19
Pennelli con setole morbide,
ideali per realizzare fondali
e per dipingere ampie superfici



04142

blister 1 pennello ø cm.1,2x14,5
Pennello tondo con setole corte
per lavori di "picchiettatura" tipici
della pittura con stencil.



Pennelli



PENNELLO PIATTO PURA SETOLA, MANICO CORTO, VERNICIATO NERO

- K577/00x12** - 12 pennelli n° 0
- K577/02x12** - 12 pennelli n° 2
- K577/04x12** - 12 pennelli n° 4
- K577/06x12** - 12 pennelli n° 6
- K577/08x12** - 12 pennelli n° 8
- K577/10x12** - 12 pennelli n° 10
- K577/12x12** - 12 pennelli n° 12
- K577/14x12** - 12 pennelli n° 14
- K577/16x12** - 12 pennelli n° 16
- K577/BL5** - set 5 pennelli: 0-2-4-6-8
- 03691** - set 3 pennelli: 2-4-6
- 03692** - set 3 pennelli: 8-10-12



PENNELLO TONDO PURA SETOLA, MANICO CORTO, VERNICIATO NERO

- K766/00x12** - 12 pennelli n° 0
- K766/02x12** - 12 pennelli n° 2
- K766/04x12** - 12 pennelli n° 4
- K766/06x12** - 12 pennelli n° 6
- K766/08x12** - 12 pennelli n° 8
- K766/10x12** - 12 pennelli n° 10
- K766/12x12** - 12 pennelli n° 12
- K766/14x12** - 12 pennelli n° 14
- K766/16x12** - 12 pennelli n° 16
- K766/BL5** - set 5 pennelli: 0-2-4-6-8
- 03693** - set 3 pennelli: 2-4-6
- 03694** - set 3 pennelli: 8-10-12



PENNELLO TONDO PELO DI BUE EXTRAFINE CHIARO, MANICO CORTO LACCATO

- 1248/00x12** - 12 pennelli n° 0
- 1248/01x12** - 12 pennelli n° 1
- 1248/02x12** - 12 pennelli n° 2
- 1248/03x12** - 12 pennelli n° 3
- 1248/04x12** - 12 pennelli n° 4
- 1248/05x12** - 12 pennelli n° 5
- 1248/06x12** - 12 pennelli n° 6
- 1248/07x12** - 12 pennelli n° 7
- 1248/08x12** - 12 pennelli n° 8
- 1248/09x12** - 12 pennelli n° 9
- 1248/10x12** - 12 pennelli n° 10
- 1248/11x12** - 12 pennelli n° 11
- 1248/12x12** - 12 pennelli n° 12
- 04140** - set 3 pennelli misure: 2-6-8



PENNELLO TONDO IN PELO DI PONY, SETOLE MORBIDE E RESISTENTI, MANICO CORTO LACCATO

- JP101/N01x12** - 12 pennelli n° 1
- JP101/N02x12** - 12 pennelli n° 2
- JP101/N03x12** - 12 pennelli n° 3
- JP101/N04x12** - 12 pennelli n° 4
- JP101/N05x12** - 12 pennelli n° 5
- JP101/N06x12** - 12 pennelli n° 6
- JP101/N07x12** - 12 pennelli n° 7
- JP101/N08x12** - 12 pennelli n° 8
- JP101/N09x12** - 12 pennelli n° 9
- JP101/N10x12** - 12 pennelli n° 10
- JP101/N11x12** - 12 pennelli n° 11
- JP101/N12x12** - 12 pennelli n° 12
- 04148** - set 3 pennelli misure: 2-6-8

PENNELLO PIATTO IN PELO SINTETICO TORAY MANICO CORTO VERNICIATO

- 06226** - n° 0 larghezza setole mm.6
- 06227** - n° 2 larghezza setole mm.7
- 06228** - n° 4 larghezza setole mm.9
- 06229** - n° 6 larghezza setole mm.11
- 06230** - n° 8 larghezza setole mm.14
- 06231** - n° 10 larghezza setole mm.19
- 06232** - n° 12 larghezza setole mm.24



pag.116
pennelli sintetici
per i più grandi





KR971857

blister 5 pennelli sintetici
manico in plastica colorata
Resistenti e forme assortite



08026

blister 12 pennelli
in pelo di bue
misure assortite



11649

blister 8 pennelli sintetici - per colori acrilici

11651

blister 8 pennelli sintetici - per acquerelli

11650

blister 8 pennelli pura setola - per colori a olio



Pennellesse



Pennellesse in pura setola con
manico in plastica colorata.
Possono essere utilizzate con ogni
tipo di colore. Facilmente lavabili.

K555/25x12

12 pennellesse - larghezza mm.25

K555/38x12

12 pennellesse - larghezza mm.38

K555/50x12

12 pennellesse - larghezza mm.50

K555/63x12

12 pennellesse - larghezza mm.63

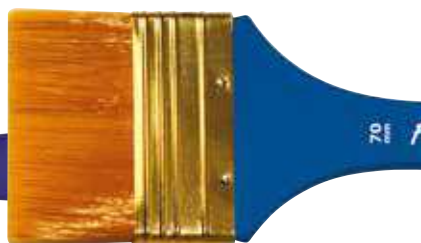

**PENNELLESSA
SYNTETIC FRIDA**

Manico in legno.

10935/15 - setola cm.1,5

10935/20 - setola cm.2

10935/30 - setola cm.3

10935/40 - setola cm.4

10935/50 - setola cm.5

10935/70 - setola cm.7



**PENNELLESSA
PURA SETOLA ANDY**

Manico in legno.

10920/15 - setola cm.1,5

10920/20 - setola cm.2

10920/25 - setola cm.2,5

10920/30 - setola cm.3

10920/40 - setola cm.4

10920/50 - setola cm.5

10920/70 - setola cm.7

10920/100 - setola cm.10

Spatole

06646

spatola "Uni" cm.8x11
in materiale
resistente ai solventi.
Ideale per inchiostri,
gessi, ceramica, stucchi.



06824

confezione 6 spatole (in gomma)
lunghezza cm.8, larghezze
mm.10, 13, 15, 20, 25, 30.
Ideali per lavori più piccoli
e dettagliati.



09165

set 4 spatole (in plastica)
cm.13x8



cm.5x5,5



06654

set 4 spatole/pettini (in EVA)
forme assortite

06765

set 4 spatole (in plastica)
cm.17 forme assortite
Resistenti ai solventi.



mm.25 mm.45 mm.50 mm.60



06650

set 4 spatole/pettini (in gomma)
forme assortite

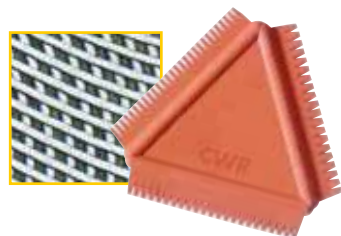

04332

spatola triangolare
(in gomma) cm.10x10x10
Sono utilizzabili tutti e 3 i lati

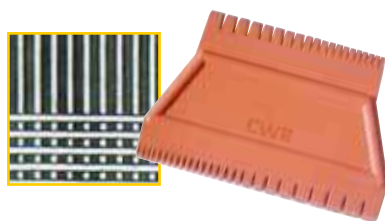

04333

spatola rettangolare
(in gomma) cm.8x12
Sono utilizzabili entrambi i lati

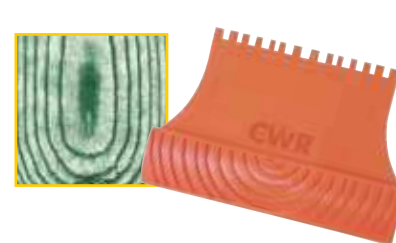

06649

spatola (in gomma) cm.8x12
Sono utilizzabili entrambi i lati

Pennelli effetti

Pennelli in soffice gomma EVA e in spugna: immergeteli nel colore, e create meravigliosi effetti!



NOVITA'

2
PEZZI

KR972315

blister 2 pennelli effetti in gomma EVA



NOVITA'

2
PEZZI

KR972316

blister 2 pennelli effetti in gomma EVA



NOVITA'

2
PEZZI

KR972326

busta 2 rulli in spugna



NOVITA'

5
PEZZI

KR972349

blister 5 pennelli in spugna
con impugnatura ergonomica



10554

set 5 spatole/pennelli fantasia



Pennellotti e timbri



10552
set 4 pennellotti fantasia

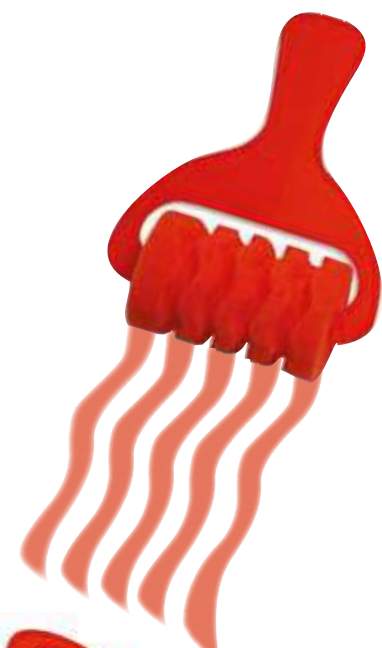

10555
pennello "asterisco"



10551
set 4 timbri in spugna



10553
set 3 rulli in spugna fantasia



T512/25x12

12 pennelli spugna larghezza cm.2,5

T512/50x12

12 pennelli spugna larghezza cm.5

T512/75x12

12 pennelli spugna larghezza cm.7,5

T512/100x12

12 pennelli spugna larghezza cm.10

06640

busta 5 pennellesse assortite

06640

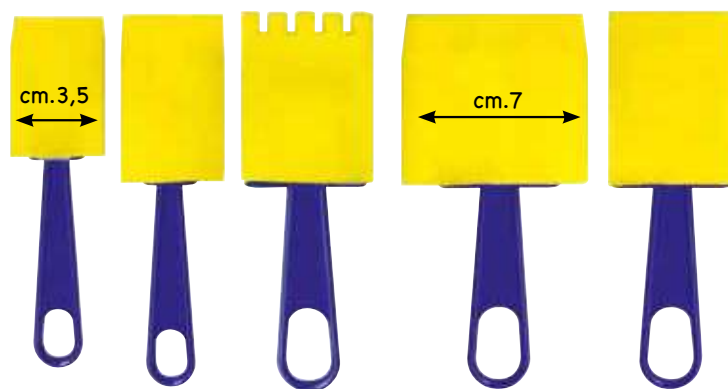

Pennelli a dita

Un modo originale per avvicinare i bambini al mondo del colore: pennelli che si calzano sulle dita! Ideali per incrementare l'esperienza tattile e cromatica.

05060

busta 9 pennelli a dita



Rulli

Rulli in spugna con morbide applicazioni di soggetti sagomati, utilizzabili con tempere, colori acrilici, ecc... Lavabili con acqua e sapone.



07252

busta 3 rulli in spugna con applicazioni motivi: cerchi, linee, quadrati



07253

busta 3 rulli in spugna con applicazioni motivi: farfalle, cuori, stelle



04555

05016

04556

04555 - rullo in spugna larghezza cm.4x2,5 ϕ

04556 - rullo in spugna larghezza cm.7,5x3,5 ϕ

05016 - rullo in spugna con scanalature per decorazioni - larghezza spugna cm.4x15

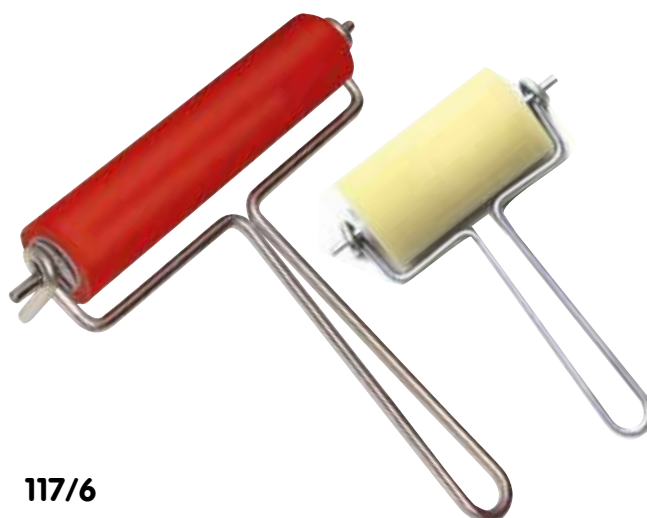

117/6

rullo ϕ cm.2,2x6

117/10

rullo ϕ cm.2,2x10

117SP/7

spugna cm.6 - ϕ cm.3,5

Setaccio a spruzzo

Utilizzato insieme a un comunissimo spazzolino a setole dure, permette di ottenere un effetto molto simile a quello prodotto dall'aerografo.



04337

setaccio per pittura a spruzzo cm.19x14

Spruzzatore a cerniera

Lo spruzzatore a cerniera è costituito da due bracci in metallo: l'estremità di un braccio dev'essere intinta nel contenitore del colore (precedentemente diluito con acqua). Per ottenere l'effetto spray/aerografo basta soffiare nell'altra estremità: il colore fuoriuscirà "vaporizzato". Utilizzare colori atossici.



15

spruzzatore cm.15



pag.112
inchiostri

Spugne per decorazioni

Spugne naturali lavabili con acqua e sapone.



NOVITA'

12883

tamponi spugna \varnothing mm.35 (12 pz.)
Pratico applicatore in spugna che consente di distribuire con precisione il colore o l'inchiostro, evitando di sporcarsi le dita grazie all'impugnatura in plastica.



NOVITA'

12476x24

24 tamponi \varnothing spugna cm.1,5

04553x12

12 tamponi \varnothing spugna cm.2

12477x12

12 tamponi \varnothing spugna cm.3

04554x12

12 tamponi \varnothing spugna cm.4

06830

set 2 tamponi \varnothing cm.2 e 4

12478

set 24 tamponi \varnothing cm.1,5 - 2 - 3 - 4

12478



06030

spugna sintetica rettangolare cm.5x7

NOVITA'

spugna naturale

12863 - \varnothing cm.4/5 (3 pz.)

06029 - \varnothing cm.9 circa

06028 - \varnothing cm.12 circa



Microspugne in vero lattice per tamponature e sfumature con colori acrilici, tempere, colori ad olio, gessi, ecc.

07245

spugne in lattice - set 4 pezzi



10450

set 6 spugnette cm.5,5x6,5



10451

set 4 tamponi cm.6x7



10640

set 4 microspugne in vero lattice



12584

conf. 6 mini cuscinetti per tempera con spugna cm.7

Timbri in spugna

Un modo semplice e veloce per realizzare simpatiche decorazioni a tampone su tutte le superfici con colori a tempera, acrilici, ecc.



impugnatura
rigida mm.7
spugna

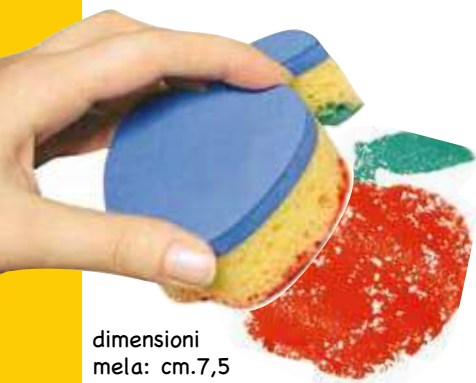

dimensioni
mela: cm.7,5



09951
set 5 timbri in spugna
soggetti natalizi



cm.12

09952
set 5 timbri in spugna
soggetti natalizi



09953
set 7 timbri in spugna
soggetti animali



09954
set 7 timbri in spugna
soggetti animali



cm.9

09955
set 8 timbri in spugna
soggetti assortiti



09956
set 8 timbri in spugna
soggetti assortiti

Timbri in spugna



05437
busta 14 timbri in spugna
soggetti: animali assortiti



05438
busta 16 timbri in spugna
soggetti assortiti



05439
busta 10 timbri in spugna
soggetti natalizi assortiti



● **03738**
set 9 timbri
soggetti frutta e verdura

Timbri in EVA



24
PEZZI



NOVITA'

12884

set 24 timbrini in gomma (8 disegni assortiti)
Facilmente lavabili, si applicano sulle dita e permettono ai bambini di stampare su carta e altre superfici.
Indicati per sviluppare la motricità fine e per realizzare originali lavoretti, biglietti d'auguri, decorazioni scrapbooking...

Timbri autoinchiostranti



15344

set 10 timbri autoinchiostranti cm.4,5
soggetti assortiti

Timbrini dei giudizi

Ideali per insegnanti, questi timbrini preinchiostriati consentono di valutare l'operato degli studenti utilizzando 4 espressioni facciali molto eloquenti e colorate. Un modo pratico e divertente per esprimere il proprio giudizio senza essere troppo severi!



Autoinchiostranti
4 espressioni facciali
4 colori di inchiostro
Lunga durata
Stampa mm.20



NOVITA'

12655

set 4 timbrini dei giudizi preinchiostriati
(diametro stampa mm.20 circa)

Timbri in legno

46
PEZZI

12654

timbri in legno (46 pezzi)
+ 2 cuscinetti inchiostrianti
scatola in legno cm.19,5x13,5x2,5
timbro in legno cm.2x2x2,5



Timbri in legno



● **05592**
uva cm.2,5x3,5



● **05600**
sole cm.5x5

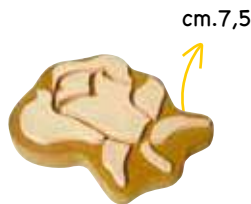

● **05065**
confezione 2 timbri
(in legno) rosa e cuore
+ 1 pennello incluso



● **05534/6**
conf. 6 timbri (in
legno) fiori e farfalle
cm.3,6x4,5x2,2 h



● **05601**
foglie cm.5x5,5



● **05599**
piuma cm.2x8,5

Sagome adesive

Posizionabili sui rulli o sulle basi/
tamponi per creare simpatici timbri.

da 05021 a 05030

set 3 fogli in EVA adesiva
cm.9x15



05021
numeri



05023
verdura



05024
animali



05025
animali marini



● **05026**
animali zoo



● **05027**
frutta



● **05028**
veicoli



● **05029**
fiori



● **05030**
uccelli

Spugne Gommy

Imprimi un oggetto sulla spugna
Gommy precedentemente riscaldata
con un normale asciugacapelli, poi
inchiostro e stampa!



GOMMY spugna per timbri
● **05632** - ø cm.8x3 h
● **05634** - cm.8x12x3 h
● **05635** - cm.10x15x3 h
● **05633x4**
conf. 4 spugne cm.5x7x3 h

dimensione:
cm.5x4 circa



04267



04268



04269

SET 12 STAMPI in acciaio

04267 - soggetti: 8 animali + 4 vari

04268 - soggetti assortiti

04269 - soggetti natalizi

Creare con i timbri

La valigetta contiene tutto l'occorrente per decorare con i timbri qualsiasi superficie: basta semplicemente creare o scegliere uno dei 44 soggetti in gomma rimovibile inclusi nel set e applicarlo sul tampone per fabbricare un vero e proprio timbro.

03628

valigetta "Creare con i timbri" contiene:

- 1 cuscinetto cm.9,5x10,5
- 2 tamponi piccoli cm.4,5x5,5
- 1 tampone medio cm.5,5x6,5
- 1 tampone grande cm.9,5x10,5
- 1 tampone lungo cm.4,5x14,5
- 44 soggetti in gomma adesiva rimovibile da applicare sui timbri



10383

busta 6 timbri a tamponi con impugnatura timbro: cm.6x6 - fantasie assortite

Cuscinetti e tamponi



03623

cuscinetto per colori cm.6,3x23

03622

cuscinetto per colori cm.9,5x10,5



03621

scatola 5 tamponi ø cm.4,
1 cuscinetto cm.9,5x10,5

03620

busta 10 tamponi ø cm.4
(5 grana grossa + 5 grana fine)



07150

set 1 cuscinetto
+ 6 tamponi con impugnatura
dimensioni cuscinetto: cm.10x11
dimensioni tamponi: cm.6x6,5



11473

2 cuscinetti per tempera ø cm.16
+ 2 spugne di ricambio
Ideali per timbri e colori a dita

Pratiche basi con impugnatura anatomica antiscivolo su cui applicare la sagoma del timbro.

03626 - cm.9,5x10,5

03624 - cm.4,5x5,5

03625 - cm.5,5x6,5

05020 - busta 4 basi
dimensioni: cm.5x7,5 (1 pz.),
3,5x5,5 (1 pz.), 2,5x4 (2 pz.)

05019

rullo per timbri ø cm.5x20



03626

05019



03624

05020

Stencil

Busta 6 stencil cm.14x15
in materiale acrilico lavabile.

da **06018 a 11805**
set 6 stencil cm.14x15



06018 "soggetti assortiti"



06019 "mezzi di trasporto"



06020 "soggetti pasquali"



06021 "soggetti natalizi A"



11800 "animali della fattoria"



11801 "sport"



11802 "soggetti natalizi B"



11803 "dinosauri"



11804 "frutti"



11805 "verdure"



03881/ASS

confezione 6 stencil (in plastica) cm.10x15
soggetti assortiti



2131

stencil "BUONE FESTE" in materiale acrilico cm.18x49

2132

stencil "BUON NATALE" in materiale acrilico cm.32x49

pag.259
spray neve

Stencil

Prodotti in plastica. Essendo flessibili, possono essere posizionati anche su superfici curve (bicchieri, bottiglie, colonne, ecc...). **Riutilizzabili.**

* Le immagini sono un suggerimento per la colorazione



6



● 2134/6

busta 2 stencil
treno + auto



7

● 2134/7

busta 2 stencil
aereo + nave



da 2134/1 a 2134/11

busta 2 stencil soggetti assortiti
(cm.14,5x15,5 cad.)



8

2134/8

busta 2 stencil cavallo
+ maiale



10

2134/10

busta 2 stencil sole
+ secchiello



11

● 2134/11

busta 2 stencil vaso
+ ombrello



Stencil

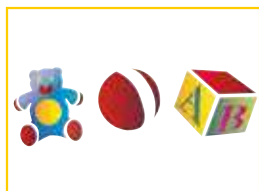

04621
giocattoli



04620
orso



2

● 2135/2
vite



3

● 2135/3
soggetti marini



4

● 2135/4
frutta



6

● 2135/6
mele

da 04620 a 04621

stencil cm.21x29,7 in plastica lavabile

da 2135/2 a 2135/11

stencil cm.20x39

Stencil in gomma

Gli stencil in gomma hanno uno spessore più alto rispetto agli stencil tradizionali. Ciò li rende particolarmente adatti per decorazioni a rilievo su ogni superficie.



04410



● 04411



● 04413



04414



● 04415



● 04416



04417

da 04410 a 04411

stencil (in gomma) cm.7,5x24

da 04413 a 04417

stencil (in gomma) cm.14,5x15,5

Pasta a rilievo

Grazie a questa pasta potrete realizzare in modo facile e pratico bellissime decorazioni a rilievo su vasi, scatole, cornici, pareti, aiutandovi anche con gli appositi stencil in gomma!



04255

barattolo ml.250

Tavolo multiuso

In legno multistrato di betulla dotato di portarotolo per carta da disegno. I bambini potranno disegnare su tutta la lunghezza del tavolo semplicemente stendendo il foglio su di esso, e strappandolo quando il lavoro è terminato.

08169

tavolo multiuso (in legno) cm.120x43x58 h
+ rotolo carta da disegno mt.20x35 cm.

08159

rotolo di ricambio carta da disegno
mt.20x35 h



Banco portacolori

Pratico e resistente, particolarmente indicato per scuole materne ed elementari. Costituito da due ampi ripiani sui quali appoggiare i colori. Il ripiano superiore è dotato di 16 fori di circa 7 cm di diametro, nei quali posizionare i bicchieri portacolori. Le pratiche ruote, consentono di spostarlo senza fatica.

08168

banco portacolori (in legno)
con ruote cm.43x120x63 h
Contiene: 16 bicchieri di sicurezza,
2 bicchieri portapennelli ø cm.10,
2 grandi bacinelle



Carrelli disegno/pittura



12480

carrello pittura (in legno)
cm.46x73x78 h con ruote



● **08113**

carrello pittura (in legno) cm.52x70x60 h
con ruote e pannello cm.33x67



Dotato di pannelli e vani portacolori, utilizzabile contemporaneamente da entrambi i lati. Struttura in legno con ruote.

Cavalletto artistico



Il Cavalletto Artistico include:
gessi colorati, rotolo di carta,
bordo bianco magnetico,
lavagna per gessi, barattoli
per vernice, cancellino

BJ420

cavalletto Artistico per ragazzi
in legno cm.41x48x89 h

BJ421

rotolo di carta cm.30x15 mt.



Cavalletto per bambini con due facciate: su un lato lavagna sintetica verde per gessetti e sull'altro bianca per marcatori a secco/acquerelli. Completo di mensola portacolori, portarotolo per carta e sistema di regolazione semplicissimo. Adatto per bambini di età superiore ai 3 anni. Peso 10 kg.

BIFACCIALE



05750

cavalletto pittura bifacciale
cm.61x70x118 h
(carta esclusa)



Bifacciale. Robusta struttura in legno, provvista da entrambi i lati di pratiche mensole con alloggiamenti per i bicchieri dell'acqua. Pinze reggifogli incluse.

08110

cavalletto pittura bifacciale cm.60x125 h
(carta esclusa)



10118

portarotolo da disegno
(in legno) cm.50x20x12 h
(carta esclusa)



10119

portarotolo completo di pannello
(in legno) cm.108x50x12 h

Supporto a muro per rotoli di carta. La struttura del portarotolo, ben rifinita e smussata, è dotata di mensola per riporre i colori. Predisposizione sul pannello portarotolo degli appositi fori per ancoraggio a muro.

Grembiuli



- Poliestere impermeabile
- Dotato di maniche per una protezione completa
- Colorato e super comodo
- Chiusura a strappo
- Età: 1-3 anni
- Lavabile con un panno umido



11909

maniche lunghe taglia S (2-4 anni)
cm.48x39

11910

maniche lunghe taglia M (4-6 anni)
cm.52x43

NOVITA'

KR972327

grembiolino per pittura



**CHIUSURA
POSTERIORE**

Lavabile con un panno umido



06962

senza maniche con tasca portatutto
(taglia unica) cm.52x43



● **1638**

senza maniche cm.45x60



04958

10 grembiuli smancati
(taglia unica) cm.44x52
in plastica leggera



Black Scrap

Questa tempera super coprente e opaca consente di realizzare con grande facilità bellissimi lavori di Scratch Art, la pittura a graffio: Fai un disegno utilizzando pastelli a cera o a olio Copri il disegno con uno strato di tempera Black Scrap (si applica facilmente con un rullo o un pennello!) e lascia asciugare Graffia la superficie con un punteruolo, e vedrai apparire i colori del disegno!



NOVITA'

12882

BLACK SCRAP tempera per incisione gr.200

Scratch Art

Anche i bambini più piccoli potranno realizzare bellissimi capolavori di Scratch Art, la pittura a graffio! Il set è composto da 10 fogli rivestiti di un magico materiale nero che, se graffiato con gli appositi punteruoli, farà comparire graffiti colorati! Basta fare un disegno sul foglio e graffiarne i contorni con il punteruolo.

esempio



NOVITA'

12901

set graffiti contiene 10 fogli cm.14x10 + 10 punteruoli cm.14

Vernice lavagna



11342

vernice lavagna ml.250

Vernice effetto "lavagna", scrivibile con pennarelli per lavagne e gessetti. Grazie a questa vernice ogni superficie in legno, metallo, ceramica può essere trasformata in lavagna.

Utilizzabile anche su pareti imbiancate (per quelle non imbiancate è consigliato l'utilizzo di un fissativo).



11341

11341 - vernice magnetica gr.120



12068

12068 - vernice magnetica gr.500

Vernice magnetizzante, che trasforma le pareti ed i supporti in uno scudo metallico su cui attaccare fogli di carta, fotografie, avvisi con il supporto di piccoli magneti. La vernice magnetica è scrivibile con gessetti morbidi. Lavabile al 100% con acqua.

Medium

POLY ACRIL

08094 - flacone ml.1000

Trasforma i colori a tempera in colori acrilici: basta unire Poly Acril alle tempere in percentuale del 50% e mescolare con cura.

POLY TEX

08095 - flacone ml.1000

Trasforma i colori a tempera in colori per tessuti, con cui sarà possibile colorare e decorare abiti, scarpe, e qualsiasi altro oggetto in stoffa. Unite Poly Tex ai colori a tempera in percentuale del 60% e mescolate con cura.

UNI-MEDIUM

12114 - flacone ml.1000

Un solo prodotto per tanti usi:

- da solo è trasparente e permette di "plastificare" le superfici o impermeabilizzare oggetti in gesso o ceramica a colata.
- unito ai colori a tempera in parti uguali li trasforma in colori acrilici o per tessuti (100gr di tempera con 100gr di medium)
- unito a della porporina diventa una colla glitter.



Vernideco

Vernice lucidante protettiva

Vernice trasparente, protegge e dona a qualsiasi oggetto un effetto laccato e ceramico. Aderisce tenacemente ad ogni tipo di supporto: carta, tela, ceramica, porcellana, pasta di sale, vetro... Conserva i colori e li protegge dalla polvere evitandone l'ingiallimento.

621/300

flacone ml.300

622

flacone ml.400



06714

barattolo ml.70

Resina acrilica neutra trasparente a base acqua. Aumenta la brillantezza e l'elasticità dei colori acrilici e dei colori a tempera. Questa resina può essere anche impiegata come vernice finale.

Vernici spray

Nei classici colori natalizi, ideali per decorare anche le superfici più estese.



615/1
bombola spray ml.150
colore oro

615/2
bombola spray ml.150
colore argento



*La grafica delle bombole spray può variare

Vernice Spray

Prodotto innovativo a base acqua che consente di verniciare senza difficoltà qualsiasi superficie. Lo spray AQUA aderisce perfettamente a ogni supporto ed è ECOLOGICO. Per questo è delicato anche su materiali fragili come il polistirolo. Utilizzabile per ambienti esterni. Conforme alla normativa DIN 71-3, può essere utilizzato anche sulle superfici che verranno a contatto con i bambini (giocattoli, mobili ecc...). NON CONTIENE METALLI PESANTI, NÉ PROPELLENTI CFC.



Spray ml.350

- | | | |
|--------------|---|----------------------|
| 09271 |  | Nero profondo lucido |
| 09272 |  | Bianco puro lucido |
| 09273 |  | Giallo colza |
| 09274 |  | Verde foglia |
| 09275 |  | Verde giallo |
| 09276 |  | Arancio pastello |
| 09277 |  | Rosso fuoco |
| 09279 |  | Blu cielo |
| 09280 |  | Blu ultramarino |









Colori Acrilici

I colori Deco Acril aderiscono ad ogni tipo di supporto non grasso: carta, legno, tessuti, tele, argilla, polistirolo, ceramica, plastica, pasta di sale, ecc... Non ingialliscono, asciugano rapidamente, sono miscelabili tra loro e coprenti.

3 flaconi ML.35

3 pezzi/monocolore

| | | |
|-------------------|---|---------------|
| D330/U01x3 |  | Bianco |
| D330/U26x3 |  | Giallo |
| D330/U17x3 |  | Arancio |
| D330/U07x3 |  | Rosa |
| D330/U25x3 |  | Magenta |
| D330/U06x3 |  | Carminio |
| D330/U12x3 |  | Verde chiaro |
| D330/U14x3 |  | Verde medio |
| D330/U21x3 |  | Cyan |
| D330/U10x3 |  | Blu oltremare |
| D330/U28x3 |  | Terra |
| D330/U02x3 |  | Nero |



D330/A
valigetta 10 flaconi ml.35



Colori per ceramica

I colori a freddo Deco Ceramic permettono di dipingere su ceramica, porcellana, terracotta. Pronti per l'uso: basta semplicemente agitare il flacone per ottenere un prodotto fluido ed omogeneo. Brillanti, intensi, perfettamente resistenti alla luce, asciugano rapidamente. Diluibili con acqua e miscelabili tra loro. Per pulire gli oggetti decorati si consiglia di utilizzare un panno umido evitando di strofinare. Attenzione! I colori Deco Ceramic sono studiati per bambini e hobbisti: a base acqua, non richiedono l'asciugatura negli appositi forni; di conseguenza gli oggetti decorati non devono essere lavati come le normali stoviglie!



3 flaconi ML.35

3 pezzi/monocolore

| | | |
|-------------------|---|---------------|
| 1634/U01x3 |  | Bianco |
| 1634/U26x3 |  | Giallo |
| 1634/U17x3 |  | Arancio |
| 1634/U25x3 |  | Magenta |
| 1634/U06x3 |  | Carminio |
| 1634/U12x3 |  | Verde medio |
| 1634/U21x3 |  | Cyan |
| 1634/U10x3 |  | Blu oltremare |
| 1634/U28x3 |  | Terra |
| 1634/U02x3 |  | Nero |



1634
valigetta 10 flaconi ml.35
colori assortiti



1634/5
set 5 flaconi ml.35
colori assortiti

pag.49
marker porcellana

Colori per vetro

Colori trasparenti per dipingere a freddo su vetro, metallo, lastre in plexiglass, ecc... Pronti per l'uso, miscelabili tra loro e diluibili con acqua. Si asciugano molto rapidamente e possiedono un'ottima resistenza alla luce. Per pulire gli oggetti decorati utilizzate un panno umido. Non strofinare. Non adatti ad ambienti umidi.



3 flaconi ML.35

3 pezzi/monocolore

| | | |
|-------------------|--|---------------|
| 1632/U01x3 | | Bianco |
| 1632/U26x3 | | Giallo |
| 1632/U17x3 | | Arancio |
| 1632/U06x3 | | Carminio |
| 1632/U07x3 | | Rosa |
| 1632/U12x3 | | Verde medio |
| 1632/U10x3 | | Blu oltremare |
| 1632/U28x3 | | Terra |
| 1632/U02x3 | | Nero |
| 1632/U00x3 | | Incolore |



1632
valigetta 10 flaconi ml.35
colori assortiti



1632/5
set 5 flaconi ml.35
colori assortiti

Finto piombo Contorno a rilievo

Ideale per tracciare profili e delimitare i colori su vetro e ceramica. Si stende e si lavora grazie al pratico beccuccio di precisione.



TUBETTO ML.20

- 1642/1** - nero
- 1642/2** - grigio
- 1642/3** - oro
- 1642/4** - argento



Glass DECO

Colori **rimovibili e riposizionabili** per vetro, plexiglass, plastica... Con il liner disegnate sul film trasparente e colorate con i tubetti colore. Quando i colori saranno asciutti rimuovete delicatamente la decorazione e attaccatela su vetri e finestre!

05889
set Glass Deco contiene: 5 colori in tubetto ml.10,5, 1 liner nero ml.10,5, 1 film trasparente



Colori per tessuti

I colori Deco Textile permettono di realizzare splendide decorazioni su tessuti. Pronti per l'uso, miscelabili tra loro e diluibili con acqua. Grazie alla loro particolare composizione non si alterano nel tempo e sono resistenti ai lavaggi, anche in lavatrice (temperatura consigliata: 30°C).



3 flaconi ML.35

3 pezzi/monocolore

| | | |
|-------------------|--|---------------|
| 1633/U01x3 | | Bianco |
| 1633/U26x3 | | Giallo |
| 1633/U07x3 | | Rosa |
| 1633/U25x3 | | Magenta |
| 1633/U06x3 | | Carminio |
| 1633/U12x3 | | Verde medio |
| 1633/U21x3 | | Cyan |
| 1633/U10x3 | | Blu oltremare |
| 1633/U28x3 | | Terra |
| 1633/U02x3 | | Nero |



1633/5
set 5 flaconi ml.35
colori assortiti

1633
valigetta 10 flaconi ml.35
colori assortiti

Tessuti

Tessuti di qualità utilizzabili con colori e marker per tessuti.

VOILE GR.42 (100% cotone)

12259 - cm.140x140

12260 - cm.140x3 MT.

MICROSATIN GR.80 (100% poliestere)

12261 - cm.160x160

12262 - cm.160x3 MT.

TELA GR.120 (100% cotone)

12263 - cm.150x150

12264 - cm.150x3 MT.

268

foulard poliestere tinta unita cm.80x80



Telaio

Un classico strumento di artigianato realizzato in legno per allenare destrezza e creatività di grandi e piccini.

266/3 - cm.30x30

266/5 - cm.50x50

266/7 - cm.80x80

266/120 - cm.120x120



pag.48
marker per tessuti

Cartoni telati

Cartoni alto spessore (non si imbarcano o deformano con colori, liquidi e colle) proposti in svariati formati, rivestiti con pregiata tela per artisti. Supporto perfetto per colori a olio, tempera, acquerelli, acrilici, paste a rilievo, ecc.



CARTONE OVALE

- 06004** - cm.5x8
- 06005** - cm.12x18
- 06006** - cm.16x22
- 06456** - cm.24x30
- 06457** - cm.30x40

CARTONE TONDO

- 06007** - ø cm.8
- 06008** - ø cm.12
- 06009** - ø cm.15
- 06010** - ø cm.22
- 06458** - ø cm.30



PER BAMBINI

CARTONE RETTANGOLARE MM.2,5

- 384/1824** - cm.18x24
- 384/2030** - cm.20x30
- 384/2535** - cm.25x35
- 384/3040** - cm.30x40
- 384/4050** - cm.40x50

PER ARTISTI

CARTONE RETTANGOLARE MM.3

- 354/1015** - cm.10x15
- 354/1318** - cm.13x18
- 354/1520** - cm.15x20
- 354/1824** - cm.18x24
- 354/2025** - cm.20x25
- 354/2030** - cm.20x30
- 354/2430** - cm.24x30
- 354/2535** - cm.25x35
- 354/3040** - cm.30x40
- 354/3050** - cm.30x50
- 354/3550** - cm.35x50
- 354/4050** - cm.40x50
- 354/5060** - cm.50x60
- 354/5070** - cm.50x70



350

cartone predisegnato cm.30x40 (soggetti assortiti nell'imballo da 60 pezzi) Al cartone è unita la cartolina-guida a colori relativa al soggetto da dipingere.



● 08676

set 12 cartoni predisegnati cm.30x40 (6 nature morte + 6 fiori)



● 08675

set 12 cartoni predisegnati cm.30x40 (6 soggetti marini + 6 paesaggi)



08057

10 fogli cm.23x33 gr.160/mq - bianco/avorio

08058

10 fogli cm.50x70 gr.160/mq - bianco/avorio

CARTA TELATA

2001

album da 10 fogli di carta telata preparata per pittura ad olio, tempera e acrilici cm.24,5x34,5

● 2011

album predisegnati in carta telata da 10 fogli (soggetti assortiti) con la traccia disegnata dell'opera e la relativa cartolina fotografica cm.24,5x34,5



Tele per pittura

Tela di altissima qualità con texture a grana media. Ideale per tutte le tecniche, sopporta perfettamente anche massicce applicazioni di colore senza danneggiarsi. Rivestita con tre strati di gesso universale, pronta all'uso, consente un assorbimento bilanciato dei colori. Non contiene acidi (questo garantisce una lunga durata della tela). Bordi al vivo che consentono di dipingere anche i lati della tela per conferirle un look moderno. Può essere appesa senza il bisogno della cornice. Barre tenditela professionali in legno per garantire un'eccellente stabilità e resistenza. La struttura degli angoli consente di regolare la tensione della tela.



PER BAMBINI

TELA PER PITTURA MM.16
minimo acquistabile: 12 pezzi

- 385/1824** - cm.18x24
- 385/2535** - cm.25x35
- 385/3040** - cm.30x40
- 385/4050** - cm.40x50
- 385/5070** - cm.50x70

PER ARTISTI

TELA PER PITTURA MM.16 CLASSIC
minimo acquistabile: 12 pezzi

- 355/1318** - cm.13x18
- 355/1824** - cm.18x24
- 355/2020** - cm.20x20
- 355/2430** - cm.24x30
- 355/2535** - cm.25x35
- 355/3040** - cm.30x40
- 355/3070** - cm.30x70
- 355/3550** - cm.35x50
- 355/4050** - cm.40x50
- 355/5070** - cm.50x70
- 355/70100** - cm.70x100



Per tutte le tecniche:
OLIO, ACRILICO, TEMPERA, MISTE...

PER ARTISTI

TELA PER PITTURA MM.38 MODERN (ALTO SPESSORE)

- 356/1530** - cm.15x30 (minimo 12 pezzi)
- 356/2030** - cm.20x30 (minimo 12 pezzi)
- 356/2040** - cm.20x40 (minimo 12 pezzi)
- 356/2050** - cm.20x50 (minimo 12 pezzi)
- 356/3040** - cm.30x40 (minimo 12 pezzi)
- 356/3070** - cm.30x70 (minimo 12 pezzi)
- 356/3080** - cm.30x80 (minimo 6 pezzi)
- 356/3090** - cm.30x90 (minimo 6 pezzi)
- 356/3550** - cm.35x50 (minimo 12 pezzi)
- 356/4050** - cm.40x50 (minimo 12 pezzi)
- 356/4080** - cm.40x80 (minimo 6 pezzi)
- 356/5060** - cm.50x60 (minimo 12 pezzi)
- 356/5070** - cm.50x70 (minimo 6 pezzi)
- 356/6080** - cm.60x80 (minimo 6 pezzi)
- 356/70100** - cm.70x100 (minimo 6 pezzi)



12699
PACK SCUOLA pz.45
mini tela cm.6,3x9



12698
PACK SCUOLA pz.24
mini cavalletti in legno
cm.7x12 h

Indicato per lavoretti
di classe!



Tavolozze

Ideali per la pittura a olio



175/2030

tavolozza rettangolare (in legno)
cm.20x30



180/1824

tavolozza ovale (in legno)
cm.18x24

180/2030

tavolozza ovale (in legno)
cm.20x30



04547

04548

SCODELLINI Ø CM.5
CON CLIP PER TAVOLOZZA

04547

scodellino singolo con coperchio

04548

scodellino doppio con coperchio

Pratiche, resistenti,
facilmente lavabili

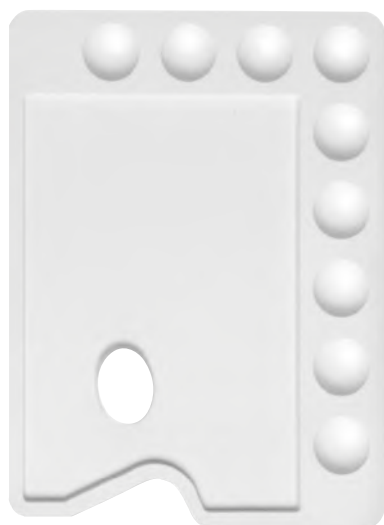

165

tavolozza rettangolare (in plastica)
cm.17x25 (9 scomparti)

166

tavolozza rettangolare (in plastica)
cm.19x28 (9 scomparti)



184

tavolozza ovale (in plastica)
cm.17x24 (7 scomparti)

185

tavolozza ovale (in plastica)
cm.22x30 (9 scomparti)



Tavolozze



10560

vassoio (in plastica) cm.24x33
(interno formato A4)

10142

vassoio (in plastica) cm.28x36

10561

vassoio (in plastica) cm.33x45
(interno formato A3)



12048

tavolozza (in plastica) \varnothing cm.20
con coperchio salvacalore



12049

tavolozza (in plastica) \varnothing cm.20
con bicchiere



196

maxi piatto/tavolozza
(in plastica) \varnothing cm.31,5



04956

tavolozza (in plastica) cm.25x35
(20 scomparti)

05329

tavolozza (in plastica) cm.25x35
(20 scomparti) con coperchio salvacalore



169

tavolozza (in plastica)
rettangolare cm.32x42
(18 scomparti)
Ideali per lavorare creta
e paste modellabili



Tavolozze



203

tavolozza "Poker" (in plastica) cm.15x43
4 scomparti ø cm.9

I fori contenenti il colore sono di dimensioni molto grandi per potere ospitare le grandi quantità di colore che sono soliti usare i bambini. Prodotta in resistente materiale acrilico lavabile.



164

tavolozza "Murales" (in plastica)
6 scomparti ø cm.7 - cm.16,5x24,5

Ideale per tutti coloro che fanno uso di grandi quantità di colore, come ad esempio i pittori di murales. Impugnatura comoda a due dita.



190

bacinella "Sole" (in plastica)
9 scomparti ø cm.20



183

bacinella "Fiore" (in plastica)
7 scomparti cm.18x18

Bacinella studio



171

maxi bacinella (in plastica)
cm.28x28x4 h in scatola singola
litografata

Dotata di molteplici scomparti; ideale per riporre grandi quantità di colore, barattoli ecc. Particolarmente indicata per scuole materne ed elementari.



Tavolozze

pag.68
maxi acquerelli



08987

tavolozza (in plastica) cm.21x21
(16 scomparti)

scomparti capienti
ideali per maxi
acquerelli



11473

2 cuscinetti (in plastica) per tempera
Ø cm.16 + 2 spugne di ricambio.
Ideali per timbri e colori a dita.



09692

tavolozza (in plastica) Ø cm.31
(12 scomparti)

09693

tavolozza (in plastica) Ø cm.31
(12 scomparti) con coperchio trasparente



11329

4 piatti bianchi per
colori (in plastica)
Ø cm.22



08988

tavolozza (in plastica) cm.14x33
(11 scomparti)



10752

tavolozza (in plastica)
cm.20x29x4,5 h (6 scomparti)

Bacinelle giganti per rulli

Maxi bacinelle rettangolari, particolarmente indicate per lavori di linoleografia e pittura con rulli. La superficie inclinata consente di stendere i colori in modo omogeneo. La vaschetta raccoglie il colore in eccesso. Comode anche come base di appoggio per evitare di sporcare la superficie di lavoro. Prodotte in resistente materiale acrilico lavabile.

04669



04670



04669

bacinella (in plastica) cm.22x32 - 1 scomparto

04670

bacinella (in plastica) cm.22x32 - 2 scomparti



04671

bacinella rettangolare (in plastica) cm.30x45
3 scomparti grandi e 6 scomparti piccoli

Portacolori

Posti sul banco di lavoro, questi interni consentono di assegnare un posto a tutti gli strumenti utilizzati per dipingere e di avere tutto a portata di mano, mantenendo in ordine la superficie di lavoro ed evitando di rovesciare i colori. Prodotti in resistente materiale acrilico lavabile.

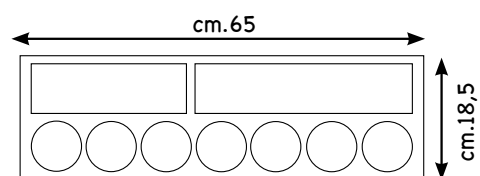

BA12/1

portacolori (in plastica) cm.18,5x65x5 h

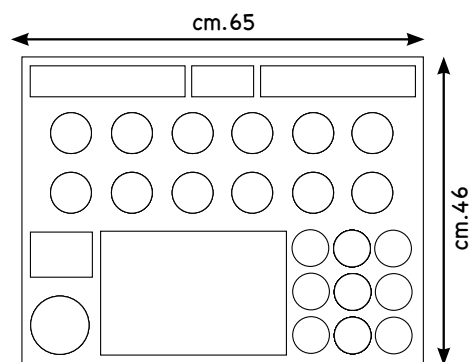

BA12/2

portacolori (in plastica) cm.46x65x5 h



pag.84
banco portacolori

Barattoli

Pratici barattoli calamaio in materiale acrilico antiurto. Dotati di un particolare coperchio studiato per evitare che l'acqua utilizzata per dipingere possa rovesciarsi. Il coperchio, inoltre, è dotato di canalini a rilievo su cui è possibile appoggiare il pennello senza rischiare di sporcare il disegno o la superficie di lavoro.



1171/1x6

6 barattoli calamaio con coperchio (in plastica) ml.330 ø cm.8,5x9,5 h



08101

12 ciotole (in plastica) colori assortiti



06022

PACK SCUOLA
10 barattoli calamaio (in plastica)
ml.160 - colori assortiti



06024

tavolozza (in plastica) cm.15x22
+ 3 barattoli calamaio ml.160



08033

4 bicchieri (in plastica antiurto) ml.250

Salvacolore



06098

salvacolore colorbox (in plastica)
composto da 6 vani a chiusura ermetica



06051

tavolozza salvacolore (in plastica) cm.16x23
completa di 12 vasetti estraibili con coperchio
a chiusura ermetica

Ciotole



177

10 ciotole impilabili (in plastica)
 ø cm.6



172

bicchiere portapennelli in materiale trasparente contenente una piramide costituita da 5 ciotole in plastica (ø cm.3,5 - 4,2 - 5,2 - 6,2 - 7,5)

172/5

piramide 5 ciotole in plastica (bicchiere escluso)



12481

confezione 4 bacinelle assortite (in plastica)
 2 quadrate cm.10x10 + 2 tonde ø cm.10,5



174

5 ciotole sovrapponibili (in plastica) ø cm.9 + 1 coperchio



173/3x5

5 set scodellini da 3 ciotole (ø cm.6 - 6,7 - 7,5) con coperchio

173x10

10 set scodellini da 5 ciotole (ø cm.3,3 - 4 - 4,4 - 5 - 5,5) con coperchio



06220

6 ciotole sovrapponibili (in plastica) ø cm.12



178x10

10 ciotole antirovescio (in plastica)
 ø cm.9x4 h



179

12 ciotole impilabili (in plastica)
 ø cm.9x4 h



08100

4 ciotole (in plastica)
 ø cm.16



07536

6 bacinelle impilabili (in plastica) cm.11x9x2 h



11330

4 vassoi pittura (in plastica)
cm.24x13x1,5 h



12513

bacinella (in plastica) cm.28x13x1,4

12512x4

4 basi portapennelli (in plastica)
cm.21x4x3,5 h - 6 posti



09884

ceppo (in legno) portapennelli
(10 posti) base cm.21x10x2,4 h
+ barattoli calamaio con coperchio ml.330



09883

ceppo portapennelli (18 posti)
in multistrato di betulla
base cm.21x10x2,4 h

Portapennelli e lavapennelli



1171/K

12 bicchieri per acqua ml.330
(in plastica) ø cm.8,5x10,5 h



04158

tavolozza portapennelli + bacinella
(in plastica) cm.13x25x3 h



T221

portapennelli circolare smontabile
(in plastica) ø cm.14,5x10 h



1306

lavapennelli (in acciaio)
con bicchiere intercambiabile
ø cm.8,5x19,5 h



1304

bicchiere portapennelli (in plastica)
ø cm.8x8 h



05499

bicchieri portapennelli
con divisori estraibili (in plastica)
ø cm.10,5x11 h (in scatola)

05473

set 2 bicchieri portapennelli con divi-
sori estraibili + bacinella (in plastica)
ø cm.10,5x11 h (in scatola litografata)



linea per i più grandi

Tempera



TUBO
ML.12

E1336
scatola 12 tubi tempera ml.12
colori assortiti



TUBO
ML.16

C1623
scatola 10 tubi tempera ml.16
colori assortiti



TUBO
ML.12

09593
scatola 12 tubi tempera ml.12
colori assortiti

E1338
scatola 18 tubi tempera ml.12
colori assortiti

TUBO
ML.22

09591
scatola 6 tubi tempera ml.22
colori assortiti

09592
scatola 10 tubi tempera ml.22
colori assortiti

Colori a tempera

04217

valigetta cm.17x23 contiene:
12 tubi tempera ml.12 colori assortiti,
tavolozza, 3 pennelli, 5 scodellini



02001

valigetta cm.17x23 colori assortiti, contiene:
24 tubi tempera ml.12, 1 tavolozza, 4 pennelli



09793

valigetta cm.25x30 colori assortiti, contiene:
12 tubi tempera ml.12 assortiti, 1 tavolozza cm.17x25,
1 telaio Classic cm.18x24, 2 tubi tempera ml.22 bianco
di zinco, 2 pennelli pelo di bue, 5 ciotole con coperchio



09862

valigetta cm.25x30 colori assortiti, contiene:
12 tubi a tempera da ml.12, 5 ciotole da pittura,
3 pennelli in setola, 1 cartone telaio



09882

valigetta cm.25x30 colori assortiti, contiene:
18 tubi a tempera da ml.12, 5 ciotole da pittura,
2 pennelli, 1 cartone telaio



linea per i più grandi

linea per i più grandi

Acrilici

Colori acrilici dalla consistenza leggera che possono essere diluiti con acqua oppure utilizzati anche direttamente dal vasetto poichè aderiscono immediatamente alle superfici. Una volta essiccati diventano impermeabili.



ML
60

Flacone ML.60

| | | |
|-----------|--|-------------------------|
| 11947/104 | | Bianco di titanio |
| 11947/201 | | Carnicino |
| 11947/210 | | Giallo Napoli |
| 11947/215 | | Giallo limone |
| 11947/227 | | Giallo primario |
| 11947/304 | | Arancio brillante |
| 11947/302 | | Scarlatto |
| 11947/324 | | Vermiglione |
| 11947/326 | | Rosso di cadmio |
| 11947/315 | | Carminio |
| 11947/336 | | Rosso primario magenta |
| 11947/400 | | Blu primario ciano |
| 11947/455 | | Azzurro ceruleo |
| 11947/453 | | Blu di cobalto |
| 11947/443 | | Blu oltremare |
| 11947/408 | | Violetto |
| 11947/559 | | Verde smeraldo |
| 11947/509 | | Verde chiaro |
| 11947/568 | | Verde vescica |
| 11947/676 | | Giallo ocra |
| 11947/684 | | Terra di Siena bruciata |
| 11947/690 | | Bruno Van Dyke |
| 11947/793 | | Nero di carbonio |

METAL

| | | |
|-----------|--|---------|
| 11947/901 | | Oro |
| 11947/902 | | Argento |



12022

valigetta Acrì contenente:
- 15 flaconi acrilici ml.60 colori assortiti
- 15 cartoncini telati



11944

valigetta Acrì contenente:
- 10 flaconi acrilici ml.60 colori assortiti
- 1 tavolozza in acrilico
- 2 spatole in acrilico
- 6 pennelli in pura setola
- 2 spugnette

Colori acrilici



ML
60

11945
scatola 4 flaconi acrilici ml.60
(cyan, magenta, giallo, bianco)

11946
scatola 6 flaconi acrilici ml.60
(cyan, magenta, giallo, nero, 2 bianchi)



ML
100

11535/A5
scatola 5 acrilici tubo ml.100
colori primari assortiti



NOVITA'

12945
scatola 6 acrilici (tubo ml.100)
colori della pelle (art.11535/201, 11535/210,
11535/601, 11535/676, 11535/684, 11535/690)

Flacone ML.100

| | | |
|------------------|--|-------------------------|
| 11535/103 | | Bianco di zinco |
| 11535/104 | | Bianco di titanio |
| 11535/201 | | Carnicino |
| 11535/210 | | Giallo Napoli |
| 11535/215 | | Giallo limone |
| 11535/213 | | Giallo di Cadmio |
| 11535/227 | | Giallo primario |
| 11535/301 | | Giallo Arancio |
| 11535/304 | | Arancio brillante |
| 11535/302 | | Scarlatto |
| 11535/324 | | Vermiglione |
| 11535/326 | | Rosso di cadmio |
| 11535/315 | | Carminio |
| 11535/336 | | Rosso primario magenta |
| 11535/400 | | Blu primario cyan |
| 11535/455 | | Azzurro ceruleo |
| 11535/453 | | Blu di cobalto |
| 11535/443 | | Blu oltremare |
| 11535/450 | | Blu Ftalo |
| 11535/445 | | Blu di Prussia |
| 11535/408 | | Violetto |
| 11535/559 | | Verde smeraldo |
| 11535/538 | | Verde permanente |
| 11535/509 | | Verde chiaro |
| 11535/568 | | Verde vescica |
| 11535/676 | | Giallo ocre |
| 11535/601 | | Terra di Siena naturale |
| 11535/684 | | Terra di Siena bruciata |
| 11535/687 | | Terra d'ombra bruciata |
| 11535/688 | | Terra d'ombra naturale |
| 11535/690 | | Bruno Van Dyke |
| 11535/793 | | Nero di carbonio |
| 11535/797 | | Grigio di Payne |
| 11535/791 | | Nero di Marte |

Flacone ML.100 FLUO

| | | |
|------------------|--|--------------|
| 11535/151 | | Arancio fluo |
| 11535/152 | | Giallo fluo |
| 11535/157 | | Rosa fluo |
| 11535/161 | | Verde fluo |

Flacone ML.100 METAL

| | | |
|------------------|--|---------|
| 11535/901 | | Oro |
| 11535/902 | | Argento |
| 11535/975 | | Bronzo |

Colori acrilici

Colori acrilici dalla consistenza leggera che possono essere diluiti con acqua oppure utilizzati anche direttamente dal vasetto poiché aderiscono immediatamente alle superfici. Una volta essiccati diventano impermeabili.



Flacone ML.150

| | | |
|-----------|--|------------------------|
| 08607/104 | | Bianco di titanio |
| 08607/200 | | Carnicino chiaro |
| 08607/215 | | Giallo limone |
| 08607/227 | | Giallo primario |
| 08607/304 | | Arancio brillante |
| 08607/302 | | Scarlatto |
| 08607/324 | | Vermiglione |
| 08607/326 | | Rosso di cadmio |
| 08607/315 | | Carminio |
| 08607/336 | | Rosso primario magenta |
| 08607/400 | | Blu primario cyan |
| 08607/455 | | Azzurro ceruleo |
| 08607/453 | | Blu di cobalto |
| 08607/443 | | Blu oltremare |
| 08607/408 | | Violetto |
| 08607/559 | | Verde smeraldo |
| 08607/509 | | Verde chiaro |
| 08607/568 | | Verde vescica |
| 08607/676 | | Giallo oca |
| 08607/690 | | Bruno Van Dyke |
| 08607/793 | | Nero di carbonio |

| | | |
|-----------|--|-------------|
| 08607/899 | | Oro pallido |
| 08607/902 | | Argento |

09865
confezione 6 flaconi assortiti ml.150



Flacone ML.250

| | | |
|-----------|--|-------------------------|
| 08794/104 | | Bianco di titanio |
| 08794/201 | | Carnicino chiaro |
| 08794/227 | | Giallo primario |
| 08794/304 | | Arancio |
| 08794/324 | | Vermiglione |
| 08794/326 | | Rosso di cadmio |
| 08794/336 | | Rosso primario magenta |
| 08794/400 | | Blu primario cyan |
| 08794/453 | | Blu di cobalto |
| 08794/443 | | Blu oltremare |
| 08794/408 | | Violetto |
| 08794/538 | | Verde permanente |
| 08794/509 | | Verde chiaro |
| 08794/684 | | Terra di siena bruciata |
| 08794/793 | | Nero di carbonio |

09188
confezione 6 flaconi assortiti ml.250



Colori acrilici

linea per i più grandi



09585
scatola 12 tubetti ml.12 colori assortiti

E818
scatola 18 tubetti ml.12 colori assortiti



09583
scatola 6 tubetti ml.22 colori assortiti

09584
scatola 10 tubetti ml.22 colori assortiti



09861
valigetta cm.25 x 30
contiene: 18 tubetti acrilici ml.12,
1 tavolozza, 3 pennelli, 1 cavalletto



09794
valigetta cm.25 x 30,
contiene: 1 tavolozza in materiale acrilico cm.17 x 25,
1 telaio Classic cm.18 x 24, 12 tubetti acrilici ml.12
colori assortiti, 2 tubetti acrilico ml.22 bianco di zinco,
3 pennelli in setola, 5 ciotole con coperchio



D330/U30x3
3 flaconi acrilico ml.35 oro
D330/U31x3
3 flaconi acrilico ml.35 argento

04922
set 2 flaconi ml.35 (oro e argento)



● **05441**
barattolo ml.150 argento



D330/5
set 5 flaconi ml.35
(cyan, magenta, giallo, bianco, nero)

04962
set 5 flaconi ml.35 colori natalizi assortiti

linea per i più grandi

Olio

Colori di qualità professionale che offrono elevate prestazioni a un prezzo ragionevole. Questi colori a olio sono fabbricati con pigmenti di prima qualità e testati al fine di ottenere colori brillanti e intensi.



E1386

scatola 12 tubetti ml.12 colori assortiti



09587

scatola 6 tubetti ml.22 colori assortiti

09588

scatola 10 tubetti ml.22 colori assortiti

04218

valigetta cm.17x23 colori assortiti
12 tubetti olio ml.12, 1 bacinella cm.12x23,
3 pennelli pura setola, 1 scodellino, 1 spugna
ø cm.5,8x1,8 h

09795

valigetta cm.25x30, contiene:
1 tavolozza in legno cm.18x25, 1 telaio Classic
cm.18x24, 12 tubetti a olio ml.12 assortiti,
2 tubetti a olio ml.22 bianco di zinco, 3 pennelli
pura setola, 1 scodellino singolo con coperchio
e clip



Acquerelli

Pigmenti di qualità, PER ARTISTI E STUDENTI.
Colori brillanti, intensi e miscelabili tra loro.



11577

scatola 12 tubetti acquerelli
ml.12 colori assortiti

11578

scatola 18 tubetti acquerelli
ml.12 colori assortiti



Dimensione reale

DEMI-GODET (MEZZO GODET)
(mm.20 x 16 x 10 h)

11475

scatola 12 demi-godet colori assortiti
completa di pennello e tavolozza

Aquart brush

PENNELLO CON SERBATOIO RICARICABILE. Pratico e unico prodotto con punta a pennello in setole. Può essere riempito con acqua o inchiostri per molteplici utilizzi: manga, grafica, fumetto, acquerello. Ricaricabile.

AquArt®

12060
set 3 PENNELLI
punte assortite

12060/1
pennello punta fine

12060/2
pennello punta media

12060/3
pennello punta grande



linea per i più grandi

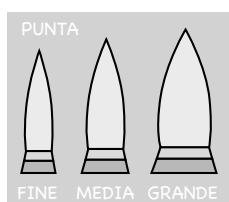

1. svitare e riempire il serbatoio con acqua o inchiostri
2. avvitare la punta sulla ghiera
3. premere il fusto per bagnare le setole

Calligraphy

C8772
4 marker punte assortite

Tratto deciso e modulabile, garantisce una scrittura precisa e ricca di dettagli. Punta in feltro a scalpello di varie larghezze; inchiostro nero a base d'acqua.

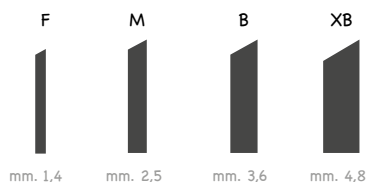

Set manga

10557
impugnatura con 5 pennini
e inchiostro



Ceralacca

4 STECCHE ceralacca cm.10
con stoppino

06642 - colori assortiti

06643 - colore rosso

● **06653** - colore nero



06644
confezione regalo: sigillo
+ stecca ceralacca cm.10



Inchiostro di china

Inchiostro di china idroresistente, scorrevole, a base di nerofumo, conferisce un tratto netto e un colore vivo.

10506

flacone ml.60

10507

flacone ml.250

10710

flacone ml.1000



10506



10507



10710



11453

confezione 10 pipette dosacolor ml.3

10508

10 flaconi assortiti da ml.60 + tavolozza e pennello

Inchiostro di china a base d'acqua, fluido, trasparente e solubile in acqua, utilizzabile puro come un acquerello. Asciugatura rapida, resistente all'acqua e allo strofinio.



10509

10 flaconi assortiti da ml.60 + tavolozza e pennello

Inchiostro acrilico a base d'acqua, semifluido, molto concentrato, diluibile in acqua. Utilizzabile su tutti i supporti, resiste all'acqua dopo l'essiccazione.



K141730

set 6 flaconi da gr.20 colori assortiti

Inchiostri colorati da disegno. Pigmenti idrodispersibili in una soluzione di resina naturale. I colori sono resistenti alla luce e miscelabili tra loro. Brillantezza assicurata anche se diluiti.



K141722

inchiostro nero opaco flacone gr.20 (adatto ai pennini)

Gesso Primer



11225

gesso primer trasparente all'acqua, flacone ml.250

Indicato per la preparazione di fondi. Può essere usato per ogni tecnica pittorica. Essiccazione rapida. Garantisce maggiore durata del dipinto. Aderisce a tutte le superfici.



09589

10536

10534

10536

gesso primer nero ad alto potere coprente, flacone ml.500

09589

gesso primer bianco ad alto potere coprente, flacone ml.500

10534

gesso primer bianco ad alto potere coprente, flacone ml.1000

linea per i più grandi

Olio di lino

L'olio di semi di lino è il diluente maggiormente utilizzato nella pittura a olio per aumentare la brillantezza dei colori e per ridurre la traccia del pennello, dilatandola e rendendo molto scorrevole la pennellata stessa. Se diluito con trementina consente di ottenere un eccellente medium per qualsiasi tipo di pittura.



10742

10743

10744

10742

olio di lino raffinato, flacone ml.125

10743

olio di lino raffinato, flacone ml.500

10744

olio di lino raffinato, flacone ml.1000

Fissativi spray ml.400

Di facile e veloce utilizzo, incolore ed anti-ingiallenti; conferiscono brillantezza alle superfici trattate e aumentano la vivacità delle tinte, senza modificarle; fissano definitivamente i colori al supporto proteggendoli dall'ossidazione e dagli agenti esterni.



EFFETTO LUCIDO E OPACO

625

626

627 e 628

625 - fissativo per carboncino, tempera, acquerelli

626 - fissativo finale Damar per colori ad olio

627 - fissativo per colori acrilici, tempera e acquerelli effetto lucido

628 - fissativo per colori acrilici, tempera e acquerelli effetto opaco

Cavalletti



05415
mini cavalletto (in legno)
cm.11x23 h



cavalletto (in legno) cm.19x36 h
0,4 kg. Altezza utile della tela cm.32

- 10546** - naturale
- 10547** - bianco
- 10548** - verde
- 10549** - fuxia
- 10550** - colori assortiti



06598
cavalletto (in legno)
cm.12x16x34 h



con catenella

09183
cavalletto (in legno)
cm.35x45x56 h



40
cavalletto da tavolo (in legno)
base cm.29x34x105
massima altezza utile del dipinto



45
cavalletto da campagna (in legno)
dimensioni: altezza chiuso cm.87
massima altezza utile del dipinto cm.118



06597
cavalletto Lira (in legno)
cm.66x87x173 h

Manichini

Ideali per artisti e laboratori d'arte, per riprodurre al meglio le fattezze del corpo umano. Prodotti in legno. Snodabili.

linea per i più grandi



- 201** - uomo (in legno) cm.31 h
- 201/1** - donna (in legno) cm.31 h
- 04542** - uomo (in legno) cm.66 h
- 04543** - donna (in legno) cm.66 h



- **04544**
bambino (in legno) cm.121 h

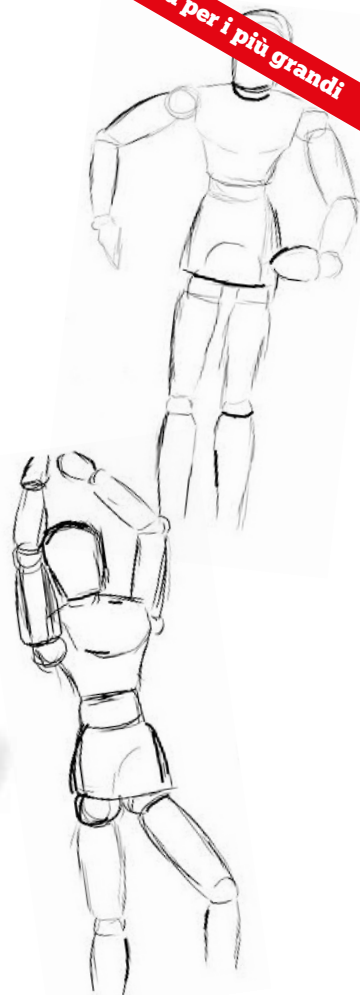

- 205**
mano destra uomo (in legno) cm.30 h
- 205/1**
mano sinistra uomo (in legno) cm.30 h
- 206**
mano destra donna (in legno) cm.25 h
- 206/1**
mano sinistra donna (in legno) cm.25 h



- 210**
cavallo snodabile (in legno) cm.45x40 h circa - base cm.30x11

linea per i più grandi



Pennelli

**PENNELLI SINTETICI VINCENT
A MANICO CORTO**

PENNELLI PUNTA TONDA

- 11000/0 - n° 0
- 11000/2 - n° 2
- 11000/4 - n° 4
- 11000/6 - n° 6
- 11000/8 - n° 8
- 11000/10 - n° 10
- 11000/12 - n° 12
- 11000/14 - n° 14
- 11000/16 - n° 16
- 11000/20 - n° 20

PENNELLI PUNTA PIATTA

- 11020/2 - n° 2
- 11020/4 - n° 4
- 11020/6 - n° 6
- 11020/8 - n° 8
- 11020/10 - n° 10
- 11020/12 - n° 12
- 11020/14 - n° 14
- 11020/16 - n° 16
- 11020/20 - n° 20



Spatole

Realizzate in materiale resistente che le rende leggere e flessibili. Ideali per l'applicazione di colore e paste su tele.



11254
busta 2 spatole
(in plastica) assortite



11370
scatola 6 spatole (in plastica)
assortite



05224
5 spatole (in plastica)
lunghezza massima cm.20

A photograph of two young children sitting at a white table, focused on playing with colorful modeling clay. The child on the left is a young girl with dark curly hair, wearing a yellow shirt and denim overalls, shaping a piece of pink clay. The child on the right is a young boy with dark hair, wearing a white t-shirt and denim overalls, working with a piece of yellow clay. The table is covered with various pieces of clay in different colors like blue, green, purple, orange, and pink. In the background, other children and a white chair are visible, suggesting a classroom or playroom setting.

Manipolazione e scultura

La modellazione è ormai considerata indispensabile nel processo di crescita di un bambino per svariati motivi: 1) **Sviluppa le capacità motorie fini e migliora la coordinazione occhio-mano: gli atti di schiacciare, rotolare, appiattire aiutano il bambino a sviluppare i muscoli che serviranno per movimenti motori fini, come per esempio tenere una matita o usare le forbici.** 2) **Modellare e manipolare una pasta da gioco aiuta ad alleviare la tensione, rilasciare l'energia in eccesso, migliorare la concentrazione ed esprimere le emozioni.** 3) **Incoraggia la creatività: creare oggetti da zero e incoraggia i bambini a espandere la loro immaginazione e pensare in modi nuovi e innovativi.**

118 **Plastilina e
paste da modellare**

123 **Accessori
per modellare**

127 **Stampi a rilievo
e polvere ceramica**

133 **Scultura per
i più grandi**

Plastilina

Totalmente naturale, a base di olio.
Non secca se lasciata all'aria aperta
Riutilizzabile
Atossica, senza conservanti
Colori brillanti e miscelabili
Priva di glutine



12709



10565

12709

conf. 6 stick Kiddy Clay gr.100
colori assortiti
Facile da modellare e sempre elastica,
non indurisce. Atossica, senza glutine.

10565

12 stick Kiddy Clay colori assortiti,
4 formine, 1 mattarello.
Totale gr.200



10567

PACK SCUOLA Kiddy Clay
24 panetti da gr.160
assortiti in 12 colori
Totale gr.3840



10566

6 stick Kiddy Clay
colori assortiti
Totale gr.50



10568

24 stick Kiddy Clay
colori assortiti
Totale gr.500



10564

4 stick Kiddy Clay
colori assortiti
Totale gr.454



10572

valigetta Kiddy Clay Totale gr.550
(7 stick colori assortiti, 7 formine, 1 mattarello)



10569

secchiello Kiddy Clay Totale gr.1240
(contiene: 13 stick colori assortiti
+ 4 formine)



10570

secchiello Kiddy Clay Totale gr.500
(contiene 7 stick colori assortiti)

Plastilina

Facile da modellare, atossica.
Sempre elastica, **non indurisce.**

panetto gr.500

- | | | | |
|--------------|-----------|--------------|-----------|
| 07020 | ○ Bianco | 07026 | ● Verde |
| 07021 | ● Giallo | 07027 | ● Azzurro |
| 07022 | ● Arancio | 07028 | ● Blu |
| 07023 | ● Rosso | 07029 | ● Viola |
| 07024 | ● Rosa | 07030 | ● Marrone |
| 07025 | ● Fuxia | 07031 | ● Nero |

07032
confezione 12 panetti gr.500
colori assortiti

07033
panetto gr.500 - 8 colori assortiti

C265
set 10 stick plastilina totale gr.200
tipo extra - colori assortiti

**SENZA
GLUTINE
NÉ ZOLFO**



● **10573**
scatola formine Kiddy Clay Totale gr.120
(12 stick assortiti in 6 colori, 6 formine,
1 stecca in plastica)



10583x6
6 scatole Pocket Animal Kiddy Clay.
Ogni scatola contiene: 4 stick per realizzare
un animale adulto e il suo cucciolo.
Totale gr.120 (assortite in 6 soggetti differenti)



10581
kit da gioco Kiddy Clay safari, contiene: 24 stick
colori assortiti, 5 set per animali, 1 set per albero,
1 fondale 3D, 1 stecca in plastica. Totale gr.500



10582
kit da gioco Kiddy Clay Animal
contiene: 24 stick colori assortiti, 5 set per
animali, 1 set per albero, 1 fondale 3D, 1 stecca
in plastica. Totale gr.500

Pasta da modellare **Super leggera**

i-CLAY rimbalza! Riutilizzabile. Asciuga all'aria. Colori brillanti e miscelabili. Atossica, ipoallergenica e priva di glutine.



SENZA GLUTINE

busta gr.50

- **07040** ○ Bianco
- **07043** ● Verde

* Volume pari a gr.200 di plastilina



secchiello gr.400

- 07050** ○ Bianco

* Volume pari a Kg.1,8 di plastilina



Plastilina **Super Soft**

SUPER MORBIDA E FLESSIBILE

Facile da modellare e sagomare. Disponibile in tanti colori brillanti, miscelabili tra loro. Atossica, senza glutine.



panetto gr.150

- 12711/01** ○ Bianco
- 12711/03** ● Giallo
- 12711/04** ● Rosso
- 12711/06** ● Verde
- 12711/09** ● Blu

NON INDURISCE



12711/A6

conf. 6 stick gr.135
colori assortiti

Plastilina **Dough**

Leggera, asciuga all'aria. Atossica, senza glutine.

12717

conf. 4 barattoli (gr.130/cad)
colori assortiti



ASCIUGA ALL'ARIA

Cartapesta in polpa

Asciuga naturalmente
Può essere dipinta con acrilici,
tempere ecc... Priva di glutine

SENZA
GLUTINE



11407

busta cartapesta in polpa gr.100

11408

busta cartapesta in polpa gr.200

Sabbia cinetica "Deco Sand"

Composta da sabbia naturale per oltre il 98%, non secca mai.
Questa sua composizione fa in modo che modellandola si creino
incredibili effetti cinetici e sembrerà che la sabbia inizi a muo-
versi e a prendere vita!!

SENZA
GLUTINE



10849

confezione 1 kg. sabbia cinetica



11344

contenitore completo di 1 kg.
di sabbia cinetica e 16 formine



Creta

Purissima, naturale al 100%
Mantiene il colore grigio se lasciata asciugare
all'aria. Assume il color mattone se cotta
negli appositi forni alla temperatura di 980
°C. Priva di glutine



272/25 - panetto kg.25

272 - panetto kg.1

Ceramica

Ceramica bianca, naturale al 100%
Asciuga all'aria o può essere cotta negli appo-
siti forni alla temperatura di 1020 °C. Dopo la
cottura assume il colore bianco opaco (ceramica
biscotto). Priva di glutine.



275/25 - panetto kg.25

275 - panetto kg.1

Pasta da modellare

- Sintetica, inodore
- Facile da modellare
- Non necessita di cottura
- Indurisce all'aria in 10/15 ore
- Può essere colorata e lucidata con vernice trasparente
- Atossica
- Priva di glutine



**INODORE, COMPLETAMENTE NATURALE,
NON CONTIENE SOSTANZE CHIMICHE**



GRANDE FORMATO

panetto kg.5

conf./monocolore

- 12253** Bianco
- 12254** Terracotta

panetto gr.500

conf./monocolore

- 11492** Bianco
- 11493** Terracotta

panetto kg.1

conf./monocolore

- 05751** Bianco
- 05752** Terracotta



panetto gr.500

conf./monocolore

- 09425** Bianco
- 09426** Giallo
- 09427** Rosso
- 09428** Verde
- 09429** Blu



MY/MW1000

panetto kg.1 pasta
per modellare bianca

MY/MT1000

panetto kg.1 pasta
per modellare terracotta



Accessori per modellare

05012

mattarello (in plastica)
con 3 ruote sagomate
intercambiabili lunghezza cm.21



ALTA
QUALITÀ
SUPER
RESISTENTI



05075

busta trafile tonda
con 4 diversi estrusori - dimensioni: \varnothing cm.2,5



12069

mattarello cm.20x2,5 \varnothing



05076

mattarello cm.22x4 \varnothing

11456

CONFEZIONE SCUOLA 8 mattarelli cm.22x4 \varnothing

11894

mattarello regolabile 3 in 1
cm.32x2,5 \varnothing

Questo speciale mattarello consente di ottenere tre diversi livelli di spessori: mm.1,7 mm.2,5 e mm.3,5.
È indicato per livellare crete, plastiline e tutte le paste da modellare.



3 IN 1
PER 3 DIVERSI
LIVELLI DI
SPESSORE



12710

set 5 attrezzi
per modellare



cm.22

04307

set attrezzi didattici (in plastica).
Contiene: 1 coltello, 1 stecca,
2 rotelle da taglio, 1 mattarello



10267

set 3 mattarelli (in legno)
con cilindro ruotante cm.24x2,8 \varnothing



04162

mattarello (in plexiglass)
cm.20x2,5 \varnothing



Formine e accessori



04309

set 8 formine assortite (in plastica)
cm.4x7 circa



273

set 9 formine assortite (in plastica)
cm.4x7 circa



14
PEZZI

06978

14 formine (in plastica)
+ accessori soggetti assortiti



10577

busta 16 formine assortite
Kiddy Clay Farfalla: cm.4,5x3,5



Formine da taglio

Ideali per realizzare bellissimi gioielli ed oggetti con i granuli plastici Plasto Small o con paste da modellare.



04266

set 6 forme assortite
cuore: cm.5x6 circa



07442

set 3 forme: stelle
stella grande: cm.9x9



07443

set 6 forme: cuori e fiori
fiore cm.4,5 / 5,5 / 6,5
cuore cm.3,5 / 4,6 / 5,7
altezza cm.1,9



07447

set 6 forme: Natale
stella: cm.5,6x5,6



07444

set 9 forme: numeri
numero 1: cm.4,5x1,5



07445

set 4 forme: famiglia
papà: cm.10x13 circa



07440

set 3 soggetti: cerchi
ø maggiore: cm. 7,5 circa

Tappeti protettivi

Ideale per proteggere tavoli e pavimenti. Ignifugo e resistente all'usura e lavabile con qualsiasi detergente.



Base con un lato liscio e uno satinato (antiscivolo). Facilmente lavabile con qualsiasi detergente, resistente.



TAPPETO PROTETTIVO

- **10821** - cm.65x65
- **10823** - cm.100 h
(vendita al metro)

TAPPETO PROTETTIVO

- **06155x10**
10 piani di lavoro cm.23x33
- **06156x10**
10 piani di lavoro cm.35x50
- **07129**
piano di lavoro cm.50x70
- **07130**
piano di lavoro cm.70x100

Basi da taglio

Base da taglio in legno di betulla. Bordi arrotondati, spessore mm. 18



spessore mm.18

- **08015** - cm.15x24
- **08016** - cm.20x29

Piano in lattice

Base soffice e morbida in vero lattice. Ideale per lavori di sbalzo, punzecchio.



- **07126** - cm.21x29,7
- **07128** - cm.15x20

Base da gioco

- Indicata per plastiline e colori
- Consente di non sporcare tavoli e pavimenti

- **11450x6**
6 basi da gioco cm.60x80
(la confezione contiene 6 disegni assortiti)



Pasta di sale

Miscela per pasta di sale naturale al 100%, composta solamente da prodotti di prima qualità: sale finissimo, farina e colla naturale. Consente di ottenere un impasto bianchissimo, liscio e facile da modellare: basta semplicemente aggiungere al preparato la quantità di acqua suggerita nelle istruzioni. Atossica. Disponibile nei colori bianco e rustico, più tendente al giallo anticato.

276

scatola pasta di sale bianca miscela gr.500

276/1000

scatola pasta di sale miscela kg.1

269

miscela gr.500 pasta di sale rustica, impasto colore anticato, non bianchissimo

276



Polveri specifiche

Prodotti molto versatili che trovano svariati utilizzi nel bricolage, nella didattica e nel fai-da-te per rendere lisce e omogenee le superfici da trattare, eliminando con facilità eventuali imperfezioni: screpolature, piccoli buchi o fessure... Istruzioni e modi d'uso sulle confezioni. Non adatte ai bambini se non sotto la supervisione di un adulto.

SCATOLA KG.1

08000

gesso alabastrino

08002

scagliola

08004

cemento bianco

08005

malta pronta

08006

stucco in polvere

08007

colla per piastrelle

SCATOLA KG.5

08003

scagliola



Silicone spray



07481

bombola spray ml.400

Lubrificante, distaccante impiegato per la sformatura di manufatti in plastica e gomma. Se spruzzato all'interno degli stampi facilita l'estrazione della forma evitando di romperla.

Vernideco



621/300



622

621/300 - flacone ml.300

622 - spray ml.400

Vernice trasparente cristallizzante, protegge e dona un effetto laccato e ceramico. Aderisce su tela, ceramica, porcellana, pasta di sale, vetro...

Verni acqua



07007

flacone Verni Acqua ml.500

Vernice trasparente di finitura a base acqua. Garantisce un effetto trasparente semi-lucido, proteggendo e lucidando la decorazione.

126 Manipolazione e scultura

Polvere di ceramica

La polvere di ceramica è un prodotto per colata a freddo. Molto resistente, asciuga rapidamente e presenta un impasto estremamente omogeneo, che permette di ottenere superfici lisce e compatte. Sulla confezione sono riportate tutte le istruzioni per lavorare e dipingere la polvere di ceramica. Disponibile in due colorazioni: bianca e terracotta.



CERAMICA BIANCA

05695 - kg.1
05696 - kg.5
2073/18 - kg.15



CERAMICA TERRACOTTA

05697 - kg.1
05698 - kg.5

pag.128

stampi
a rilievo



03921

piano per stampe a rilievo dimensione totale cm.33x44

Realizzato in materiale acrilico, con lo scopo di facilitare la realizzazione di formine ottenute per colata. Il listello mobile, posizionato nell'apposito vano, consente di adattare il piano a stampe di diversi formati.

Set ceramica a colata

Valigetta con il necessario per realizzare l'insegna "Welcome" con la polvere di ceramica. Il procedimento è molto semplice: basta aggiungere la polvere di ceramica contenuta nella busta all'acqua, mescolare e versare il composto nelle varie forme. In 4 ore la miscela sarà asciutta e pronta per essere colorata.



● **03567**

valigetta set ceramica a colata insegna "Welcome" Contiene: 5 stampe (insegna "Welcome" + le 4 stagioni), gr.500 di polvere di ceramica, gancini per appendere l'insegna, 1 pennello, acquerelli, 2 metri di filo animato, cordoncino per appendere la creazione.

Stampe a rilievo

Utilizzabili più volte con ogni materiale a colata: polvere di ceramica, gesso, resina, cera, sapone. Utilizzabili anche per le paste da modellare e come esercizio per pregrafismi.



07479

confezione 10 stampe a rilievo cm.7x12 numeri da 0 a 9

07480

confezione 30 stampe a rilievo cm.7x12 numeri assortiti

Stampi a rilievo per colata

* Le immagini sono un suggerimento per la colorazione

Utilizzabili più volte con ogni materiale a colata: polvere di ceramica, gesso, resina, cera, sapone.

da 278/1 a 278/39

stampo cm.13x19

OFFERTA!

278/ASS

confezione 20 stampi cm.13x19 soggetti assortiti



1 - sogg. natalizi 1



2 - sogg. natalizi 2



3 - orsetti



4 - astri/maschere



5 - frutta/verdura



6 - uova



7 - animali piccoli



8 - uova/maschere



9 - pupazzo di neve



10 - Babbo Natale



11 - viso Babbo Natale



12 - coppia angeli



13 pannocchie



14 - luna



15 cavalluccio



16 orsetto



17 maschera 1



18 - maschera 2



19 - maschera 3



20 - papera e tartaruga



22 - posacenere /fiore



23 - cane



24 - animali



25 - casa



26 - casette Messico



27 - casette



28 - palazzo + case

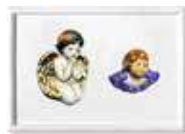

29 - angeli



30 - angelo



31 - addobbi Natale 1



32 - addobbi Natale 2



33 - soggetti marini



34 - soggetti vari



35 - crocifisso



36 - soggetti Pasqua 1



37 - soggetti Pasqua 2



38 - soggetti natalizi 3



39 - soggetti natalizi 4



Stampi a rilievo per colata

* Le immagini sono un suggerimento per la colorazione

da 2780/1 a 2780/43

stampo cm.21x23

OFFERTA!

2780/ASS

confezione 20 stampi cm.21x23

soggetti assortiti



1 - bambola 1



2 - bambola 2



3 - bambina



5 - pagliaccio



● 6 - sole/luna



7 - cesto di frutta



8 - sole



9 - 2 angeli



● 10 - case



11 - animali marini



13 - interno casa



14 - sole/luna 1



15 - sole/luna 2



17 - sole rendicastro
(o posacenere)



18 - cornice



19 - angeli su
nuvole



20 - pozzo



21 - villaggio greco



22 - stella
portacandela



23 - portacandele
natalizi



24 - Babbo Natale
con asino



25 - ciliegie



26 - angioletti



27 - animali



28 - farfalle



● 29 - casetta



30 - casette



31 - Madonna
(cm.16x19)



43 - sole

Stampi a rilievo per colata

Utilizzabili più volte con ogni materiale a colata: polvere di ceramica, gesso, resina, cera, sapone.

* Le immagini sono un suggerimento per la colorazione



da 2782/1 a 2782/20
stampo cm.29x38

OFFERTA!

2782/ASS

confezione 10 stampi cm.29x38
soggetti assortiti



1 - maschera
sole/luna



2 - ramo fiorito



3 - Madonna
con Bambino



10 - Madonna
con Bambino



4 - Babbo Natale



5 - Babbo Natale



8 - pappagallo



9 - tucano



11 - presepe
(cm.19x33)



12 - sottopentola
con paesaggio



13 - portachavi
con anatra



14 - cornice grande



15 - cornice
piccola



16 - sole e luna



17 - pupazzo di neve



19 - Papa Giovanni



20 - Giovanni Paolo II

Stampi a rilievo

* Le immagini sono un suggerimento per la colorazione

Questi stampi possiedono una superficie esterna leggermente porosa che può essere decorata con diversi materiali: colori acrilici, perlati, fluorescenti, gessetti, matite colorate, tempere, glitter, sabbia, paillettes... La superficie esterna di ogni stampo costituisce un ottimo supporto per colle, colori, vernici spray, ecc... Gli stampi, essendo molto grandi, non sono adatti per colate ma per essere decorati e colorati.



● **2785/1**
Babbo Natale cm.32x46



● **2785/2**
Pupazzo di neve cm.32x46



● **2785/3**
vassoio cm.32x46



04435
stampo "sole" cm.40x40



04527
stampo "sole" cm.47x51



04528
"sole" cm.58x58 include un plastospecchio



1340
maschera donna cm.14x20



1340/1
maschera uomo cm.15x23



1340/2
"Maya" cm.19x35



05615
donna cm.15x21



05616
clown cm.15x20



05617
maschera indiana
cm.20x27



05618
maschera greca
cm.20x27



05619
maschera leone
cm.22x26



08445
maschera sole
cm.25x27



08446
maschera grande
cm.15x21



08447
maschera piccola
cm.12x16

Stampi in lattice

Un assortimento di stampi che consentono di realizzare con facilità originali statuine tridimensionali utilizzando materiali a colata come polvere di ceramica, cera, sapone...



04986
orsetto cm.8 h



04989
ballerina cm.12 h



04990
fatina cm.12 h



● **04991**
uovo cm.10,5x7 h



● **04992**
Babbo Natale cm.10 h



04996
uva cm.10,5x7 h



04998
conchiglia cm.7x6,5 h



05000
edera cm.7x5 h



05658
pagliaccio con palla cm.11,5 h



05662
tigre cm.8,5 h



05663
elefante cm.10 h



05664
panda cm.9,5 h



05665
cavallo cm.10 h



05666
gufo cm.9 h



05667
pinguino cm.11 h



05668
gallina cm.7 h



05670
casetta cm.4x8,5 h



05673
pecorella cm.6 h



05674
unicorno cm.12 h



05678
foca cm.10 h



09544
cupido sguardo a destra cm.10 h
● **09545**
cupido sguardo a sinistra cm.10 h



05679
set 3 pastorelli cm.12 h



● **09547**
set 3 Re Magi cm.16 h

* Le immagini sono un suggerimento per la colorazione

Paste da modellare

- 270**
panetto grigio da gr.500
- 271**
panetto grigio da kg.1



Plastilina

Plastilina grigia per artisti utilizzata anche nelle scuole per realizzare sculture, teste, volti per le bambole ecc... Facile da modellare e plasmare.

Argilla da forno

Argilla di ottima qualità. Naturale al 100% Facile da lavorare, **ASCIUGA E INDURISCE** all'aria o può essere cotta negli appositi forni a una temperatura compresa tra 970 °C e 1050 °C. Priva di glutine

- 10382** - panetto kg.1,5 colore: bianco
- 09431** - panetto kg.5 colore: bianco
- 10563** - panetto kg.12,5 colore: bianco

- 10381** - panetto kg.1,5 colore: rosso
- 09430** - panetto kg.5 colore: rosso
- 10562** - panetto kg.12,5 colore: rosso



Argilla Zamora

Argilla in gres per scolpire e modellare. Eccellente plasticità. Contiene il 40% di impalpabile grog 0-0,2 mm. **Ideale per lavori a tornio e per modellare pezzi lisci ricchi di dettagli.** L'alto contenuto di grog garantisce un eccellente comportamento durante l'essiccazione e la cottura. Il suo particolare colore avorio dopo la cottura (1240-1300 °C) è molto apprezzato, e costituisce un'ottima base per smalti e ossidi coloranti.

- 12255** - Zamora kg.5 colore bianco

Argilla Granada

Argilla in gres per scolpire e modellare. Eccellente plasticità. Contiene il 40% di grog 0-0,5 mm. **Ideale per sculture, murali e lavori con la tecnica Raku.** L'alto contenuto di grog conferisce una bella superficie strutturata e un comportamento eccellente durante l'essiccazione e la cottura. Il particolare colore avorio dopo la cottura (1240-1300 °C) è molto apprezzato e costituisce un'ottima base per smalti e ossidi coloranti.

- 12256**
pasta per modellare Granada kg.5 - bianco



Pasta polimerica "Proto"

Per creare oggetti simpatici, bigiotteria e piccoli pezzi d'arte.

- Morbida e flessibile
- Miscelabile con altre paste polimeriche
- Non secca se esposta all'aria
- **Indurisce in forno a 130 °C**
- Atossica
- Priva di glutine



da 10606 a 10621

panetto unicolore gr.50 PROTO
Misure panetto: cm.6x7x1 circa

| | | |
|--------------|--|--------------|
| 10606 | | Bianco |
| 10607 | | Crema |
| 10608 | | Rosa carne |
| 10609 | | Giallo |
| 10610 | | Arancio |
| 10611 | | Fuxia |
| 10612 | | Rosso |
| 10613 | | Viola |
| 10614 | | Verde Scuro |
| 10615 | | Blu |
| 10616 | | Marrone |
| 10617 | | Nero |
| 10618 | | Verde Chiaro |
| 10619 | | Azzurro |
| 10620 | | Glicine |
| 10621 | | Nocciola |



3000 GR.

10625

PACK SCUOLA 60 panetti assortiti in 12 colori da gr.50 (tot. gr.3000)
Misure display: cm.30x30x6,5. Contiene i colori: bianco, crema, pesca, giallo, arancio, rosa, rosso, viola, verde scuro, blu scuro, marrone scuro, nero

Vernice finale per "Proto"

Vernice a base d'acqua. Indicata per proteggere le creazioni e per renderle più lucide e brillanti. Asciuga in 24 ore.



10626

flacone di vernice trasparente all'acqua per PROTO ml.10

10627

flacone di vernice trasparente all'acqua per PROTO ml.50



10623



10624

10622

blister 2 panetti (tot. gr.100) assortiti nei colori oro e argento

10623

blister 4 panetti (tot. gr.200) assortiti in 4 colori BASE

10624

blister 4 panetti (tot. gr.200) assortiti in 4 colori FLUO



10622

Stecche e mirette



256/35
barattolo 35 stecche
(in plastica) cm.18
modelli assortiti



03804
barattolo 24 stecche-mirette
(in policarbonato e acciaio)
altamente professionali



255/24
barattolo 24 mirette
cm.20 (in materiale
antiurto e acciaio)



255/BL
blister 2 mirette
+ 3 stecche



11359
busta 3 mirette
(in legno) e filo
in acciaio cm.20
modelli assortiti



254/10
10 stecche
(in plastica)
cm.18 modelli ass.



11238
busta 6 stecche
cm.15 modelli ass.
11239
busta 6 stecche
cm.20 modelli ass.



03646 03647

DOPPIO USO in materiale
antiurto e acciaio

03646
tecno-miretta cm.20
03647
tecno-miretta cm.20

Set per modellare e scolpire



T470
trafila in acciaio + 19 estrusori
dimensioni: diametro cm.1,5



T278
set per modellare e tornire la creta
(totale 8 pezzi)

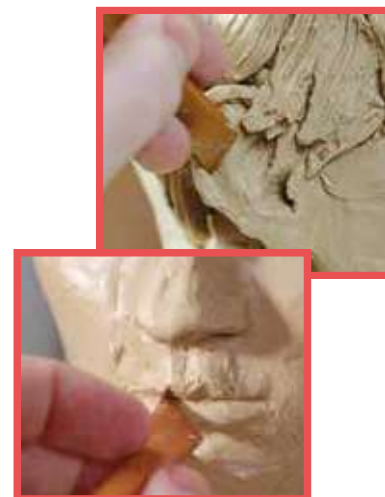

Trespoli per scultura

258

trespolo da tavolo girevole
(in legno) cm.35x35
peso kg.2,5



259

trespolo da studio girevole
(in legno) cm.35x35x100
peso kg.6



Torni per ceramica



08549

tornio da studio (in acciaio)
con gambe richiudibili, registrabile
in altezza, verniciato nero e cromato.
Altezza minima da terra cm.63,
massima cm.100



12588

trespolo da studio (in legno e metallo) piano in legno cm.34x34
altezza regolabile da 91 a 128 cm - peso 5,6 kg
Trespolo in acciaio cromato e verniciato nero con piano girevole in
legno. Regolazione altezza per mezzo dell'asta centrale scorrevole.

Forno per ceramica

262

forno per ceramica dotato
dei seguenti accessori:
1 piastra, 1 mezza piastra,
serie di colonnine a 36 triangoli
dimensioni interne: \varnothing cm.44x34h
con regolatore termocomputer,
temperatura 1260 °C - KW 3.0



257

tornio elettrico per
realizzare vasi di creta,
ceramica, terracotta...
cm.30x40x18 h



Piedistalli

Piedistalli di vari materiali, indicati per le fasi di studio del progetto degli artisti oppure per la fase espositiva.



11657

base in legno: cm.10x10x2 punta cm.25

11658

base in legno: cm.18x18x2 punta cm.40

11659

base in legno: cm.18x18x2 punta cm.60

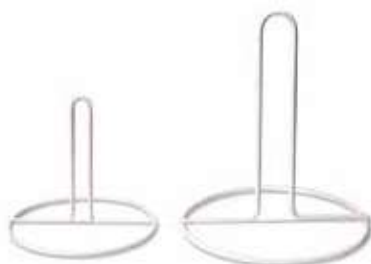

11661

base in metallo: \varnothing cm.14x12 h

11662

base in metallo: \varnothing cm.18x20 h

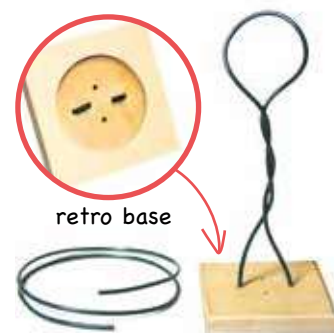

11660

base in legno: cm.10x10x2 h
contiene 2 mt. di filo animato

1747

filo animato \varnothing mm.4x100 mt.

Filo animato

Particolarmente indicato per armare e rinforzare i lavori per ceramica, gesso ecc... ma anche per realizzare gancini da annegare nell'impasto, cosicchè quando sarà asciutto potrete facilmente appendere le vostre creazioni.



1743

filo animato rivestito in plastica
 \varnothing mm.1,3x100 mt.

Garze gessate

Garze gessate a presa rapida. Stese a fasce incrociate, le garze gessate permettono di realizzare strutture sottili ma molto robuste e leggere.



06145

confezione 4 garze per modellare
mt.3x10 cm. h

Macchina per pasta da modellare

Macchina per pasta da modellare in acciaio con cui è possibile ottenere uno strato uniforme o mescolare i colori. 9 diversi spessori possibili di implementazione.



11908

macchina cm.23x20x15 circa
misura utile cm. 17,5



materiale creativo

In un mondo caratterizzato dalla tecnologia, è importante che il tempo trascorso "offline" sia riempito da attività divertenti e creative. Proponiamo qui un'ampia gamma di prodotti con cui i bambini saranno in grado di sprigionare la propria fantasia realizzando oggetti concreti, lavoretti didattici, piccoli regali e decorazioni. L'attività creativa aiuta i bambini a rallentare e a concentrarsi per realizzare un oggetto finito partendo da materiali differenti.

142 Forme
in polistirolo

181 Decorazioni in legno

212 Tecniche
artistiche

256 Festività
e ricorrenze

Forme apribili Kristall 3D

In plastica trasparente. Tutte le forme Kristall possono essere aperte e riempite oppure dipinte con colori per vetro o acrilici.



SFERA

- 05637x12** - 12 sfere ø cm. 4
- 12231x16** - 16 sfere ø cm.5
- 880/60x12** - 12 sfere ø cm. 6
- 880/80x12** - 12 sfere ø cm. 8
- 07280x12** - 12 sfere ø cm.10
- 880/120x10** - 10 sfere ø cm.12
- 09958x6** - 6 sfere ø cm.14
- 05638x6** - 6 sfere ø cm.16
- 08831x5** - 5 sfere ø cm.18



► Vedi forme con separatore a pagina successiva

Sfere apribili Senza occhiello

Indicate per lavori di découpage e decorazioni, addobbi, vetrinistica, allestimenti. Al loro interno è possibile posizionare piccoli oggetti o gadget. Possono anche essere accoppiate con le sfere Kristall. In questo modo avrete una metà coprente, e una metà trasparente.

- 12559x16** - 16 sfere ø cm.5 - trasparente
- 12559/01x16** - 16 sfere ø cm.5 - bianca
- 12559/02x16** - 16 sfere ø cm.5 - nera
- 12559/03x16** - 16 sfere ø cm.5 - rossa

Ideali anche per tombole, giochi a premio ecc. Riempite con materiali diversi (biglie, semi, riso, ecc...) possono essere utilizzate per tombole sonore ed esperimenti uditivi.



Forme Kristall Nido



05173x8

8 sfere nido kristall 3D ø cm.12 con foro



05174x5

5 gocce nido kristall 3D cm.18 h con foro

Forme kristall 3D



05920x6

6 sfere halloween ø cm.8 colore arancio

Forme apribili Kristall 3D

In plastica trasparente. Tutte le forme Kristall possono essere aperte e riempite oppure dipinte con colori per vetro o acrilici.



CUORI

881/60x5

5 cuori - cm.6

881/80x5

5 cuori - cm.8

881/100x5

5 cuori - cm.10

10355x5

5 cuori - cm.14



UOVA

04195x20

20 uova cm.6 h

04196x20

20 uova cm.10 h



STELLE

05639x5

5 stelle - cm.8 h

04194x3

3 stelle - cm.14 h



GOCCE

882/110x5

5 gocce - cm. 11 h

882/140x5

5 gocce -cm. 14 h



MEDAGLIONE

05651x10

10 medaglioni ø cm. 9



BABBO NATALE

05640x4

4 babbi Natale cm.13 h



PULCINO

04193x3

3 pulcini cm.9 h



CONIGLIO

05644x3

3 conigli cm.9 h



CAMPANA

05645x5

5 campane cm.9 h



ANGELO

05641x4

4 angeli cm.10 h



ABETE

05642x5

5 abeti cm.11 h



ORSETTO

05650x4

4 orsetti cm.10 h



CASSETTA

04191

casetta cm.10 h



FARFALLA

05649x3

3 farfalle cm.13 h



SCATOLA

04201x3

3 scatole tonde ø cm.8,5x5 h



SCATOLA

05643x3

3 scatole ovali ø cm.10x7x5 h



SCATOLA

04202x3

3 scatole ottagonali ø cm.8,5x5 h

Forme Kristall con separatore

SFERA CON SEPARATORE

- 05251x12** - 12 sfere ϕ cm.8
- 07587x12** - 12 sfere ϕ cm.10
- 05252x10** - 10 sfere ϕ cm.12
- 07716x6** - 6 sfere ϕ cm.16
- 11479** - sfera ϕ cm.18



CUORE CON SEPARATORE

- 06058x10**
10 cuori cm.10



STELLA CON SEPARATORE

- 06057x6** 6 stelle
cm.14



UOVA CON SEPARATORE

- 05166x20**
20 uova cm.10 h



- 09909x12**
12 sfere kristall ϕ cm.8
con separatore dorato 3D
"ANGIOLETTO"



- 05858x6**
6 sfere kristall ϕ cm.8
con separatore "BOLLA"

Sfere con separatore
a specchio
"EFFETTO PROFONDITÀ"

- 06234x6** - 6 sfere ϕ cm.8
- 07588x12** - 12 sfere ϕ cm.10
- 06235x10** - 10 sfere ϕ cm.12
- 07717x6** - 6 sfere ϕ cm.16



Vetrini Kristall appendibili

Possono essere decorati con colori per vetro, acrilici o ceramica e utilizzati come base per decorazioni tridimensionali. Grazie alla loro trasparenza, garantiscono un risultato sorprendente se appesi a soffitti, finestre, porte, lampadari, ecc.

- 12656x16** - 16 vetrini ϕ cm.5
- 12017x12** - 12 vetrini ϕ cm.6
- 12010x12** - 12 vetrini ϕ cm.8
- 12011x12** - 12 vetrini ϕ cm.10
- 12012x10** - 10 vetrini ϕ cm.12
- 12018x6** - 6 vetrini ϕ cm.14
- 12019x6** - 6 vetrini ϕ cm.16



- 04197x12**
12 vetrini kristall
finestre cm.6,5x9 h



- 04198x12**
12 vetrini kristall
tondi ϕ cm.8,5



- 04199x12**
12 vetrini kristall
ovali cm.10 h



- 04200x12**
12 vetrini kristall
campane cm.9,5 h



- 05648x4**
4 set Halloween n° 2
pipistrello cm.7x11
zucca cm.9x10,5

Forme di polistirolo

Oltre alla tecnica del patchwork, le forme di polistirolo si adattano a molte tecniche di decorazione. Disponibili in un vasto assortimento di soggetti, possono essere ulteriormente impreziosite con l'aiuto di nastri, occhietti, ciniglia, cordoncini e moltissimi altri materiali.

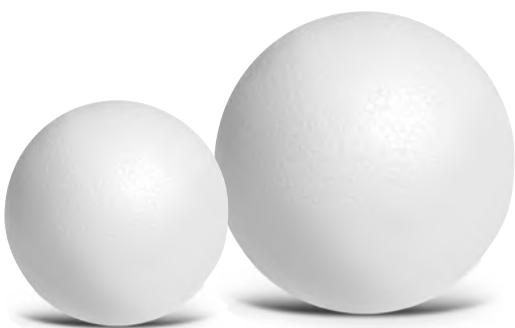

SFERA

- 816/40x50** - 50 sfere - ϕ cm.4
- 816/50x40** - 40 sfere - ϕ cm.5
- 816/60x35** - 35 sfere - ϕ cm.6
- 816/70x25** - 25 sfere - ϕ cm.7
- 816/90x16** - 16 sfere - ϕ cm.9
- 816/120x8** - 8 sfere - ϕ cm.12
- 816/140x5** - 5 sfere - ϕ cm.14



PALLA A SPICCHI

- 10772x25**
- 25 palle - ϕ cm.6
- 10771x16**
- 16 palle - ϕ cm.9



PALLA RIGATA

- 10773x10**
- 10 palle rigate ϕ cm.8



SFERA APRIBILE

- 07876x4**
- 4 sfere apribili ϕ cm.16
- 07877x2**
- 2 sfere apribili ϕ cm.20
- 10757**
- sfera apribile ϕ cm.25



UOVO APRIBILE

- 07969x5**
- 5 uova apribili cm.11x15,5 h
- 07970x2**
- 2 uova apribili cm.15,5x22,5 h
- 10769**
- uovo apribile cm.20x28 h



UOVO

- 815/12x15**
- 15 uova ϕ cm.8,5x12 h
- 815/13x22**
- 22 uova ϕ cm.5,5x8 h
- 10768x30**
- 30 uova ϕ cm.4x6 h

**CAMPANA****815/1x15**

15 campane cm.9x9,5 h

10760x6

6 campane cm.16x16 h

**FIOCCO****10758x3**3 fiocchi di neve
cm.17,5x17,5x9 h**CUORE****10763x22**

22 cuori - cm.7

815/3x18

18 cuori - cm.11

10764x7

7 cuori - cm.15

**STELLA****10761x18**

18 stelle - cm.10

10762x13

13 stelle - cm.15

815/2x11

11 stelle - cm.20

**ABETE****10767x16**

16 abeti cm.5,5x7,5 h

**SCATOLA****815/16x4**4 scatole ovali
cm.15,5x11,5 h**SCATOLA****815/17x5**5 scatole quadrate
cm.13,5x13,5**CORNICE****815/14x4**4 cornici con supporto
cm.17x24**CONO****07878x14**

14 coni - cm.4x6

07879x11

11 coni - cm.7x12

07880x6

6 coni - cm.9x20

10770x3

3 coni - cm.10x25

**PIRAMIDE****10759x6**

6 piramidi cm.9x9x12,5 h

**BIRILLO****815/18x8**

8 birilli cm.15 h

**ANGELO****10463x6**

6 angioletti cm.13 h

**PESCE****06097x8**

8 pesci cm.11x4 h

**PASSEROTTO****06096x5**

5 passerotti cm.18x9 h

**PULCINO****815/20x8**

8 pulcini cm.6x6

**PAPERA****815/7x5**

5 papere cm.16x13 h

Forme di polistirolo



ANGELO

06094x8

8 angeli cm.12,5x9 h



LUNA

815/15x4

4 lune cm.25 h



LUMACA

815/11x3

3 lumache cm.21x20 h



TARTARUGA

06095x5

5 tartarughe cm.13x6 h



GATTO

815/8x3

3 gatti cm.26 h



PAGLIACCIO

815/10x3

3 pagliacci cm.23 h



CONIGLIO

815/9x3

3 conigli cm.25 h



ORSO

815/6x3

3 orsetti cm.26 h



FRUTTA

● **06110**

set 7 soggetti piccoli (castagna, fico, kiwi, fragola, noce, aglio, cipolla)
dimensioni: castagna cm.5 h



CORONA

10765x19

19 corone - ø cm.10

815/4x12

12 corone - ø cm.15

815/5x5

5 corone - ø cm.25

CORONA

10766x14

14 corone piatte ø cm.15

REALIZZATA
CON ART.10765



Forme in cellulosa

Prodotte in carta pressata. Facili da colorare e da incollare, possono essere personalizzate ed impiegate in modo da ottenere simpatici pupazzetti con cui giocare, ma anche addobbi, decorazioni, ecc.



FUNGHETTI

09654 - cm.1,5x2
09656 - cm.3,7x4,7

20 PEZZI



BIRILLI

09657 - cm.1,7x4
09659 - cm.4x8

20 PEZZI



CAMPANE

- **09669** - cm.1,8x2
- **09670** - cm.2,8x3,7
- 09671** - cm.4,3x4,3

20 PEZZI



SFERE

- 09663** - ϕ cm.1,5 (min. 3 buste)
- 09664** - ϕ cm.3
- 09665** - ϕ cm.4

20 PEZZI



UOVA

- 09666** - cm.2,2x3
- 09667** - cm.2,8x4
- 09668** - cm.3,5x4,7

20 PEZZI



TESTE

- 09672** - ϕ cm.6
- 09673** - ϕ cm.7,5

10 PEZZI



Forme in carta pressata

CONFEZIONE SCUOLA

10209x24

24 sfere cm.7 diametro



10206



10209



GIÀ ASSEMBLATI



10841x12

12 angeli "cuore"
cm.13x10x4,5



10845x12

12 cuori
cm.9x8,4x4



10847x12

12 palle di Natale
 ϕ cm.7,5

Uova da decorare

Le uova plastiche non si rompono, hanno una superficie porosa che supporta ogni tipo di colore o collante, e consentono di ottenere gli stessi risultati realizzabili su un uovo vero! Esistono tantissime tecniche per decorare le uova: batik, stencil, découpage, timbri, foglia d'oro, mosaico, patchwork, marmorizzazione, uova di Praga, ecc... Per ottenere risultati strepitosi consigliamo di abbellire le uova con carta riso, carta velina, tovaglioli, oppure utilizzando i Deco effetti, paste da modellare o a rilievo... e quant'altro suggerisca la fantasia. Dotate di un foro che consente di appenderle, una volta decorate.



05245

conf. 6 uova cm.6,5 h
colore bianco



05246

busta 50 uova cm.6,5 h
colore bianco



05214

conf. 20 uova cm.6,5 h
colore bianco



06590

busta 50 uova cm.6,5 h
colore naturale



07256

conf. 24 uova cm.6,5 h
oro, argento



05345

busta 50 uova cm.6,5 h
colori assortiti



05734



05248

05734

confezione 50 gancini metallici
per appendere le uova

05248

confezione 100 gancini
metallici per appendere sfere e uova



03919x12

12 basi per dipingere uova e sfere
ø superiore cm.5 x 3,5 h



12583

confezione 12 basi in plastica
ø cm.8 per dipingere uova e sfere

Kit uova Paperotti

IL KIT CONTIENE:

- 12 UOVA in plastica
- 12 BASI per le uova
- 12 FACCINE + ALI + ZAMPE
- BIADESIVO



REALIZZA
UN SEGNPOSTO
PASQUALE!



08922

kit 12 uova in plastica complete di accessori fustellati per decorarle (base, faccine, zampe e ali in cartone fustellato, biadesivo) e creare simpatici paperotti

Tubolari termoretraibili per uova

Il set include 12 adesivi tubolari con vari soggetti pasquali, che potrete applicare con facilità sia sulle uova vere sia su quelle in plastica. Se utilizzate uova vere, calzate il tubolare sull'uovo; appoggiate l'uovo su un cucchiaino e immergetelo per circa 3 secondi in acqua bollente. Il tubolare aderirà immediatamente all'uovo senza fare grinze! Se invece utilizzate uova in plastica vi consigliamo di calzare il tubolare sull'uovo e riscaldarlo con un normalissimo phon per capelli.

07337x6

6 tubolari termoretraibili per uova
soggetti pasquali assortiti
(ogni set è composto da 12 tubolari)



Set "Decorare le uova"

05247

scatola "Decorare le uova"
contiene: 12 uova bianche da decorare, 1 base portauova, 12 stecchini, 12 gancini per uova, 1 panetto di creta da kg.1, libretto di istruzioni



Corpi per pupazzi

Indicati per realizzare pupazzi, bamboline.
Base ø cm.4x10,5 h

4 DIVERSI
COLORI
PER GIOCHI DI
INTEGRAZIONE

Utilizzate i ganci
art. 05248 per
appendere i pupazzi
all'albero di Natale.



09744

12 corpi per pupazzi
europei

09745

12 corpi per pupazzi etnici
(3 Europa, 3 Asia,
3 America Latina, 3 Africa)



da **06587** a **06589**

busta capelli per bambole gr.50

CONI PER PUPAZZI

2390/20

20 coni (in plastica)
ø cm.6x15 h

CORPI PER PUPAZZI

07162x6

6 corpicini (in legno) cm.9

CORPI PER PUPAZZI

815/18x8

8 birilli (in polistirolo) cm.15

06587  Biondo

06588  Castano

06589  Nero

Fantasmini da decorare

Questi originali fantasmini
sono realizzati con un par-
ticolare materiale plastico
che consente di decorarli
con qualsiasi tipo di colore,
materiale o collante.



07151

scatola 4 fantasmini (in plastica)
cm.7x8 h

Palline

Tipo ping-pong.
Indicate per realizzare teste
di pupazzi e bamboline.



817

scatola 6 palline bianche ø cm.3,5

812

scatola 6 palline assortite ø cm.3,5

Compensato di betulla

Materiale costituito da sfogliati di legno di betulla. Resistente e compatto, di colore chiarissimo caratterizzato da morbide venature arrotondate, il compensato è robusto e garantisce ottimi risultati anche se trattato con vernici, colori, impregnanti ecc. Supporta perfettamente ogni tipo di colore: olio, tempere, acrilici, ecc. Ideale come base per découpage.



pag.184
fettine di legno



RETTANGOLO Spessore mm.4

- 09985x5** - 5 pezzi cm.8,5x16
- 08566x5** - 5 pezzi cm.10x15
- 08567x5** - 5 pezzi cm.15x20
- 08568x5** - 5 pezzi cm.18x24
- 08569x5** - 5 pezzi cm.20x25
- 07482x5** - 5 pezzi cm.21x30

- 08570** - cm.25x30
- 08571** - cm.25x35
- 07483** - cm.30x40
- 08572** - cm.30x50
- 08573** - cm.35x45
- 07484** - cm.35x50
- 08574** - cm.40x50
- 08575** - cm.40x60
- 08576** - cm.50x60
- 07485** - cm.25x70
- 07486** - cm.35x70
- 07487** - cm.50x70

RETTANGOLO Spessore mm.6

- 10328x6**
6 multistrati - cm.25x30
- 10331** - cm.50x75



QUADRO Spessore mm.4

- 07573x5**
5 pezzi cm.15x15
- 07574x5**
5 pezzi cm.20x20
- 07575x5**
5 pezzi cm.25x25

QUADRO Spessore mm.6

- 10329x6**
6 multistrati - cm.30x30
- 10330** - cm.50x50
- 10332** - cm.75x75



TONDO Spessore mm.4

- 07718x5**
5 pezzi ϕ cm.7
- 07567** - ϕ cm.15
- 07568** - ϕ cm.22
- 07569** - ϕ cm.28



07715x5 5 pezzi ovali cm.7x11

- 07563**
ovale cm.12x18
- 07564**
ovale cm.16x22
- 07565**
ovale cm.24x36
- 07566**
ovale cm.36x49

- 07561**
grande semicerchio cm.36x74
- 07562**
grande semicerchio cm.28x74



- 07570**
triangolo cm.20x20
- 07571**
triangolo cm.25x25
- 07572**
triangolo cm.30x30

Supporti in legno e MDF

Gli oggetti in legno e MDF sono ideali come base per découpage, pirografia, pittura, country painting ecc.



04915
vassoio cm.30x40x4 h



06340 - vassoio ø cm.24
06341 - vassoio ø cm.30



06372 - piatto ø cm.28



05961
set 3 vassoi
dimensione massima: cm.28x37x7 h



06342x4 - 4 taglieri cm.12x22
06343x2 - 2 taglieri cm.20x30



09216
tagliere cm.12x27
09217
tagliere rigato cm.12x27



05963
set 2 portavasi
dimensione max: cm.22x23x27 h



04913
scatola con chiusura
cm.9x14x8 h



05959
set 3 scatole con chiusura
dim. massima: cm.10x17x9 h



04912
scatola cm.15x15x9 h



05413



05410



05414



05957



05958



05960

05413 - portamatite cm.10x10x8,5 h

05414 - portafoglietti cm.11,5x11,5x6,5 h

05410 - scatola con coperchio cm.10x10x6,5 h

05411 - scatola con coperchio cm.15x15x6,5 h

05957 - 3 scatole quadrate (max cm.13x13x6,5 h)

05958 - 3 scatole a cuore (max cm.13x14x5,2 h)

05960 - 2 scatole tonde (max ø cm.12x7,3 h)

Supporti in legno e MDF



04895
busta 5 posate neutre cm.31

06288
set 3 cucchiali neutri cm.30



06335
set 2 vasi con cuori
dimensione max \varnothing cm.18x16 h



06337
vaso cm.15x17x25 h

05415
cavalletto in legno
cm.11x23



04917 - portafoto cm.13x18

06370 - portafoto cm.12x17

06371 - portafoto cm.14x19



05964
armadietto portachiaavi
cm.11x17x20 h



07097
portagomitoli cm.31x17x25 h



05962
appendiabiti con mensola cm.15x60



06904
uovo mdf cm.5,5x9 h



06336
casetta per uccelli
cm.13,5x10x13,5 h

Tavole in legno

Ideali per lavoretti hobbistici
in stile provenzale e shabby chic.



spessore cm. 1,3

11627/2435 - tavola in legno cm.24x35

11627/3030 - tavola in legno cm.30x30

11627/3550 - tavola in legno cm.35x50

Tavoletta/portafogli



tavola in legno con clip

10885 - cm.14,8x21

10886 - cm.21x29,7



10824

tavoletta portafogli
cm.16x23 in masonite
con clip in metallo

Sagome in legno

Sagome in legno MDF da decorare.

pag.90
colori acrilici

pag.232
pirografo

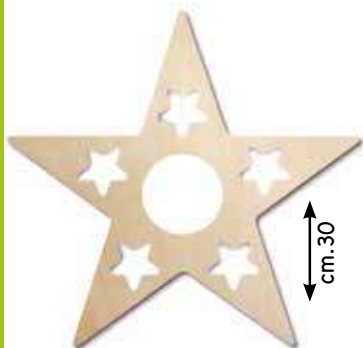

08155
stella \varnothing cm.30



08156
albero cm.20x28

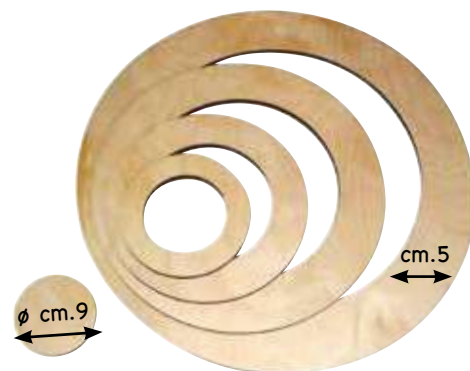

06731
set 4 corone in legno spessore mm.6
diametri esterni cm.10, 16, 25, 35



06880
cm.9x12x6 mm.

06987
cm.12x17x6 mm.

06881
cm.22x29x6 mm.

07713
cm.36x73x6 mm.



12045
 \varnothing cm.30 - 8 mm.



07714
cm.36x73x6 mm. (a punta)



12006
cm.42x120x8 mm.

Targa da decorare

Ideale come supporto per il country painting, ma anche per découpage pittorico, pittura, ecc.

08154
targa (in legno)
cm.10x18



Cornici da colorare

SB301

set 12 cornici (in legno) cm.11x12



Cucchiaini da decorare

I classici cucchiaini da cucina in legno si trasformano in divertenti personaggi, animali, burattini... Per decorare i cucchiaini è possibile utilizzare ogni tipo di materiale: cartoncini colorati, rafia, spago, occhietti mobili, pasta da modellare, Gomma Crepp, pompons, ciniglia... Una proposta economica ed originale per realizzare deliziosi lavoretti didattici.

06288

set 3 cucchiaini neutri (in legno) cm.30



Stecche natalizie

Stecche in MDF da dipingere ideali come regalini natalizi e lavoretti didattici.



● **58494**

6 stecche decorative (in legno) - soggetti natalizi

Stecche personaggi/segnalibri

Stecche in MDF con sagoma di bambino e bambina per realizzare simpatici pupazzi.



BUSTA 10 STECCHE IN LEGNO

09153

"bambino" cm.17,5x8

09154

"bambina" cm.17,5x8

Pressa per fiori

La pressa per fiori è lo strumento più semplice per seccare i fiori in modo naturale. Questa pressa è composta da due basi in legno dotate di viti a farfalla. Nella confezione è incluso anche il cartone ondulato, indispensabile per creare spessore fra una base e l'altra e attutire la pressione sul fiore.



ALL'INTERNO
TUTTE LE
SPIEGAZIONI
NECESSARIE
PER REALIZZARE
I QUADRETTI

04374

confezione completa "Pressa per fiori"

Albero genealogico

Uno strumento divertente per insegnare ai bambini i gradi di parentela e per far loro capire da dove provengono, chi sono i loro antenati ecc. Costruire l'albero genealogico aiuterà i bambini a posizionarsi all'interno della storia familiare. Ideale come regalo per i genitori o per decorare le aule della scuola materna!

12110

Kit albero genealogico

Contiene:

- 1 albero in legno cm.25x60 h
- 1 base in legno cm.12x10x1,5 h
- 4 cartoncini gr.270 cm.35x50
- 10 fermagli
- 1 punteruolo
- 2 stecchini di legno
- 1 paio di forbicine
- 1 matita
- 12 pastelli a cera
- 15 dischetti in cartoncino
- Istruzioni



REALIZZA
IL TUO ALBERO
GENEALOGICO
O UN ALBERO
DELLE STAGIONI

REALIZZAZIONE DELL'ALBERO GENEALOGICO

- 1 - Posiziona il tronco in legno su uno dei cartoncini inclusi nel set e segna con la matita la posizione dei fori
- 2 - Disegna, ritaglia e colora la chioma
- 3 - Con il punteruolo aiuta il bambino a forare il buco segnato precedentemente e con lo stecchino di legno allarga il foro ottenuto
- 4 - Utilizza i fermacampioni per ancorare la chioma al tronco in legno
- 5 - Chiedi al bambino di disegnare il volto dei membri della famiglia: i fratelli e le sorelle, i genitori, i nonni, e di scrivere i nomi sotto i disegni. In alternativa incolla sul dischetto in cartoncino le loro foto.
- 6 - Aiuta il bambino ad attaccare sulla chioma i personaggi nella giusta posizione: nonni in cima, genitori nella seconda riga e il bambino e i suoi fratelli in basso
- 7 - Completa scrivendo il titolo alla base. L'albero genealogico decorativo è fatto!

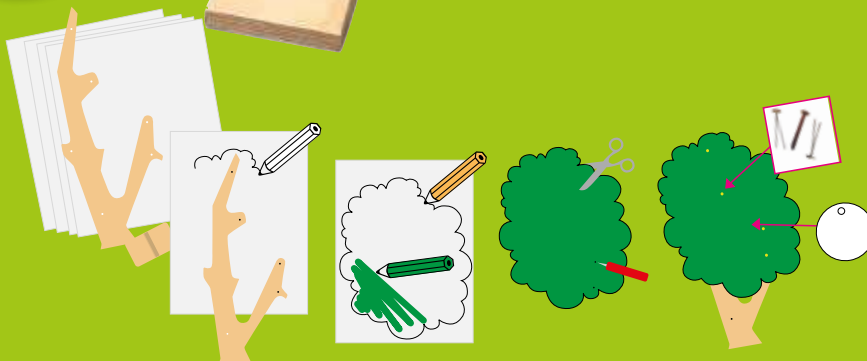

Cestini pretagliati

Per assemblare i cestini basta piegare i lati e incollare fra loro le linguette.



05518

24 cestini in cartone ø cm.20
colori assortiti



05735

busta contenente: 12 uova colorate,
1 cestino portauova in cartone da assemblare

Portamatite

I set contengono le varie componenti per costruire portamatite e 6 pastelli a cera colorati, con cui decorarli e renderli unici.

05554

set 3 portamatite fustellati in cartone da assemblare e colorare (animali assortiti) + pastelli a cera
Dimensioni: cm.13x18



Bacheca da decorare

Ideale per realizzare fantastici lavori didattici con fiori secchi o spezie, o colorando diversi formati di pasta, o ancora componendo un quadro/souvenir delle vacanze. Facile da assemblare grazie alle istruzioni contenute nel set.



07602x5 - 5 bacheche in cartone cm.21x21



07600x10

10 portafoglietti in cartone
cm.14x17 h



07601x10

10 portafoglietti in cartone
cm.18,5x34,5 h



Albero 3D

Da colorare e decorare con matite, pastelli a cera colorati, glitter...

12511

albero 3D in cartone
cm.30x20



Maxi poster da colorare

Maxi poster da dipingere prodotto su "mattboard", uno speciale cartoncino mattato (da gr. 300/mq., opaco da un lato e patinato lucido dall'altro) che può essere dipinto con qualsiasi tipo di colore.

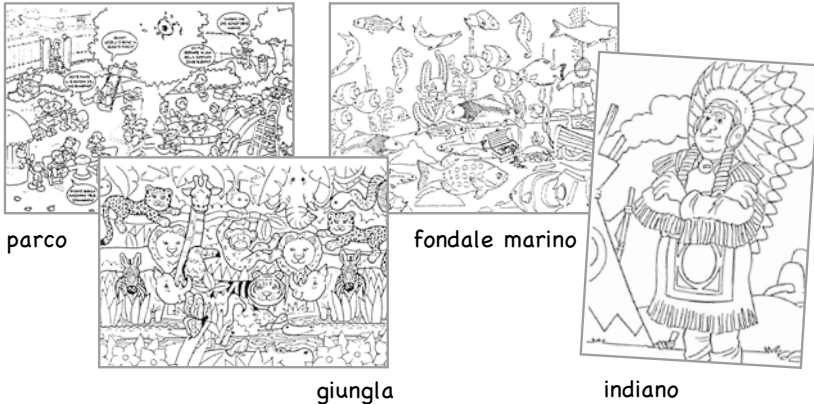

parco

fondale marino

giungla

indiano

9600

set 4 maxi poster cm.70x100 soggetti assortiti



Puzzle bianco da disegnare e colorare



05657

set 3 puzzle bianchi
cm.28x35,5



Disegna il soggetto che preferisci sulla tavoletta...



...colora il disegno e divertiti a scomporlo e ricomporlo!

Puzzle predisegnati da colorare

Questi puzzle possono essere colorati con matite, pennarelli, pastelli e colori acrilici. I disegni sono molto chiari e semplici.

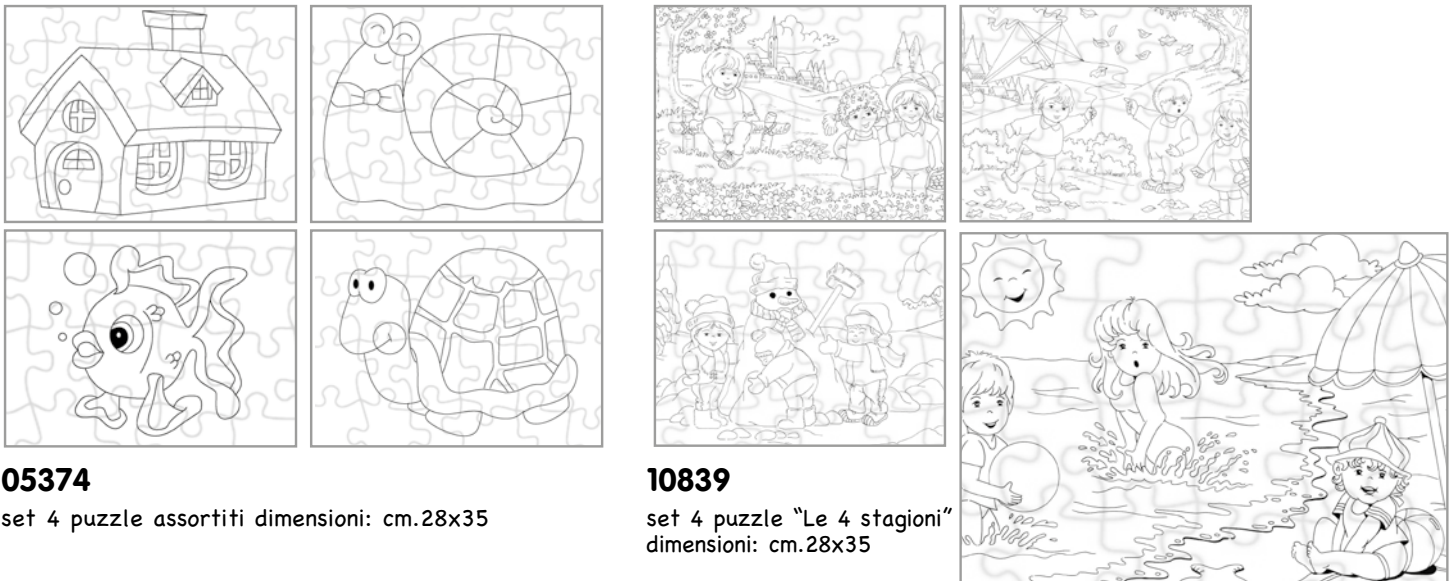

05374

set 4 puzzle assortiti dimensioni: cm.28x35

10839

set 4 puzzle "Le 4 stagioni"
dimensioni: cm.28x35

Fare le maschere

Set completo per creare bellissime maschere di animali. Nella confezione troverete istruzioni e materiali per realizzare il musetto di svariati animali.

05494

set completo per maschere, contiene: 8 maschere, 6 cartoncini pesanti, 2 cartamodelli, 2 metri di elastico



Set burattini

Set contenente tutto l'occorrente per creare simpatici burattini. Istruzioni incluse.

05497

contiene: 6 sagome base in panno-lenci, istruzioni per l'uso, fogli di panno lenci colorati per ricavarne i particolari (naso, muso, ecc...), occhietti mobili e cartamodelli per realizzare con facilità le sagome di alcuni animali



Calza di Natale

Contiene sagome pretagliate e forate per punti, **ago di sicurezza**, filo di lana e istruzioni

09169

set completo per realizzare una calza di Natale. Contiene sagome pretagliate e forate per punti, **ago di sicurezza**, filo di lana e istruzioni



Frottage

Utilizzando delle matite di varia morbidezza, pastelli, gessetti, carboncini, si sfrega il supporto lasciando affiorare a poco a poco i rilievi della superficie sottostante. Il risultato consente di ottenere dei disegni e delle textures chiaro-scure e sfumate di questi materiali utilizzati come "matrice". Queste tavolette in materiale acrilico servono appunto come matrice per realizzare decorazioni con la tecnica del frottage.



09856

set 4 matrici Frottage

09857

set Frottage contiene: 12 matrici + 12 pastelli a cera



Party Set

Originalissimi set per rendere speciale ogni festa e ricorrenza.

Ogni set include maschere o accessori in robusto cartoncino da decorare e indossare: corone, maschere, papillon, occhiali, cravatte... Scatenate la vostra fantasia e decorate il party set utilizzando pennarelli, matite colorate, pastelli, colori a tempera, glitter, pompons...

Tutti gli elementi sono dotati di cordoncino per poterli indossare facilmente, adattandoli alle dimensioni della testa o del collo di ogni bambino.



NOVITA'

12921

set 16 cappellini e corone da decorare
cappelli: cm.11-20
corone: cm.21-29

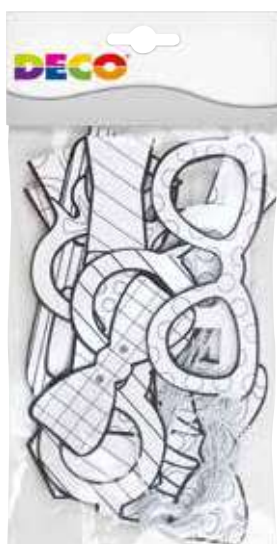
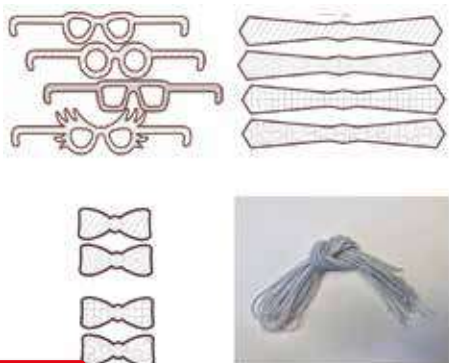

NOVITA'

12922

PARTY SET 12 pezzi
occhiali e papillon da decorare
completo di 5 mt di cordoncino



NOVITA'

12923

ANIMALI SET 16 pezzi
maschera in cartone da decorare
completo di 16 cordoncini



Party Set

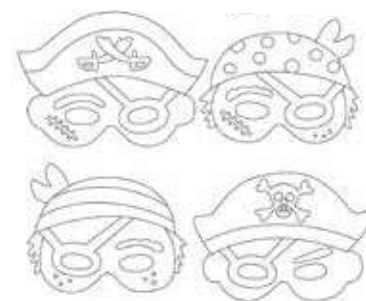
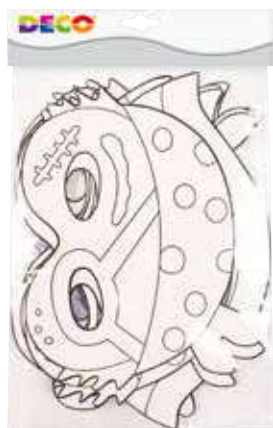

NOVITA'

12924

PIRATI SET 12 pezzi
maschere in cartone da decorare
completo di 12 cordoncini

LETTERS 123



NOVITA'

12920

set 10 fogli (1000 pezzi)
lettere e numeri in cartone
cm.3 H - colori assortiti



Porta dell'Elfo

Una porticina magica che attirerà elfi e gnomi!

I bambini potranno divertirsi a decorare questa porta per poi appoggiarla a un albero del giardino o in un angolo della propria cameretta.

Il set include anche una scaletta e la cassetta per la posta. Facilmente decorabile con colori acrilici, tempere, glitter e qualsiasi materiale creativo.

NOVITA'

12918

porta dell'elfo con scaletta
e cassetta postale
porta: 180x80 mm - scala: 110x45 mm
cassetta posta: 50x45 mm



Supporti in terracotta

Semplici vasetti di terracotta, con i quali è possibile realizzare veri e propri capolavori di originalità. La terracotta, infatti, si presta perfettamente a ogni tipo di decorazione.



TEGOLE

07616x6

6 tegole - cm.10 h

07615x6

6 tegole - cm.16 h

07617x4

4 tegole cm.25 h



VASETTI

01040x48

48 vasetti - ø cm.4

01050x48

48 vasetti - ø cm.5

10218x48

48 vasetti - ø cm.7

01090x36

36 vasetti - ø cm.9

Marker PER TERRACOTTA punta mm.4

06970 - nero

06971 - rosso

06972 - blu

06973 - verde

06974 - giallo

06975 - bianco



STELLE E FIORI

10833

set 3 stelle in terracotta cm.4.5, 5, 7

10832

set 3 fiori in terracotta cm.3, 5, 6.5



SOGGETTI IN TERRACOTTA

07631x6

6 pergamene in terracotta cm.7,5x10

07632x4

4 pergamene in terracotta cm.9x13



07633x6

6 ovali in terracotta cm.7x10 h

07634x3

3 ampolle in terracotta cm.11 h

07635x4

4 anfore in terracotta cm.16 h

Vernice all'acqua

Vernice all'acqua trasparente lucida protettiva per oggetti in terracotta.



11312

vernice all'acqua ml.35

Vernice rosso terracotta

Vernice rosso terracotta. Acrilica all'acqua. Ravvivante per soggetti in terracotta: tegole, mattoni, anfore, ecc...



11313

vernice rosso terracotta ml.35

Vasetti di sicurezza antiurto

Semplici vasetti in materiale plastico antiurto per la sicurezza del bambino. I materiali si adattano a ogni tipo di decorazione. Tramite una foratura alla base del vasetto, è possibile appendere quest'ultimo, oppure utilizzarlo per interrare piccoli semi.

MATERIALE
PLASTICO
ANTIURTO

INDICATO PER
I PIU' PICCOLI



VASETTI

12233 - 12 vasetti kristall
ø cm.4 (6 pz.) + ø cm.5 (6 pz.)

12234 - 12 vasetti color terracotta
ø cm.4 (6 pz.) + ø cm.5 (6 pz.)

12235 - 12 vasetti color verde
ø cm.4 (6 pz.) + ø cm.5 (6 pz.)

12246 - 12 vasetti color bianco
ø cm.4 (6 pz.) + ø cm.5 (6 pz.)

**APPENDI, DECORA I TUOI VASETTI
CON COLORI ACRILICI o PER CERAMICA
E COLTIVA LA TUA PIANTINA!**

CAPOVOLGERE IL VASETTO
BUCARLO PER APRIRE
IL FORO IN MODO DA
POTERLO APPENDERE,
OPPURE UTILIZZARLO PER
INTERRARE PICCOLI SEMI.

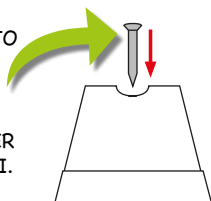

Marker per porcellana



MARKER PER PORCELLANA
PUNTA MM.2

06980 - nero

06981 - rosso

06982 - blu

06983 - verde

06984 - giallo

06985 - marrone



● **08117** - piatto ø cm.18

● **08118** - piatto ø cm.24

Portafoto "click system"

Cornici a giorno in resistente materiale acrilico infrangibile. Grazie all'esclusivo "click system", questi portafoto consentono di appendere le fotografie senza difficoltà, sia in orizzontale che in verticale, in modo pratico e sicuro utilizzando i gancini plastici a incastro inclusi nel set.



03965

cornice tonda: set 2 vetrini \varnothing cm.14 + 4 gancini

03966

cornice ovale: set 2 vetrini cm.14x20 + 4 gancini

03967

cornice rettangolare: set 2 vetrini cm.15x20 + 4 gancini

03968

cornice rettangolare: set 2 vetrini cm.23x32 + 4 gancini

05762

set cornice rettangolare: 2 vetrini cm.10x15 + 4 gancini

Passepartout

Pratici e resistenti cartoncini assortiti in molteplici forme e colori. Indispensabili per raccordare ritratti, fotografie e disegni alle cornici. Ideali per click system.



08128



08130



08129



08131

**CONFEZIONE 6 PASSEPARTOUT
COLORI ASSORTITI**

08128 - tondo con cuore \varnothing cm.14

08129 - tondo \varnothing cm.14

08130 - ovale cm.14x20

08131 - rettangolare cm.15x20

08132 - rettangolare cm.23x32

Cornici a giorno in crilex

Infrangibili. In crilex.
Ultra trasparenti.

11610/1318 - cm.13x18

11610/1824 - cm.18x24

11610/2030 - cm.20x30

11610/2129 - cm.21x29,7 (A4)

11610/2430 - cm.24x30

11610/2535 - cm.25x35

11610/2942 - cm.29,7x42 (A3)

11610/3040 - cm.30x40

11610/3550 - cm.35x50

11610/5070 - cm.50x70

11610/6080 - cm.60x80

11610/70100 - cm.70x100



Plastovetro

pag.91
colori per vetro

Materiale plastico con le stesse caratteristiche del vetro (lucentezza e trasparenza), con il notevole vantaggio di essere infrangibile. Disponibile nelle versioni liscia e "cattedrale". La superficie smerigliata "cattedrale" crea lo stesso effetto di semi-trasparenza delle vetrate delle chiese. Questi vetrini possono essere appesi, grazie agli appositi gancini in metallo che si incastrano nel bordo del vetro, senza doverli incorniciare. Ideali per lavori didattici e hobbistici.



PLASTOVETRO "CATTEDRALE"

1631/1x5

5 vetri cattedrale cm.15x20

1631/2x5

5 vetri cattedrale cm.23x32



PLASTOVETRO LISCIO CON GANCIO

03969x6

6 vetri tondi lisci - ø cm.14

03970x6

6 vetri ovali lisci - cm.14x20



PLASTOVETRO LISCIO con gancio metallico

1636/1x5

5 plastovetri lisci cm.10x15

1636/2x5

5 plastovetri lisci cm.15x20

1636/3x5

5 plastovetri lisci cm.23x32



PLASTOVETRO "CATTEDRALE"

1631/4 - busta contenente:

- 1 plastovetro cattedrale ovale cm.14x20
- 1 plastovetro cattedrale tondo ø cm.14
- 2 gancini metallici

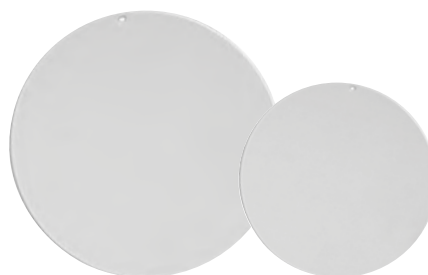

IDEALI DA DECORARE E APPENDERE OPPURE
COME SEPARATORE PER SFERE CM 6-8-10-12-14-16

Vetrini Kristall Piatti

Vetrini trasparenti prodotti in robustissimo materiale acrilico infrangibile. Possono essere decorati con colori per vetro e acrilici o utilizzati come base per decorazioni tridimensionali.

12017x12 - 12 vetrini ø cm.6

12010x12 - 12 vetrini ø cm.8

12011x12 - 12 vetrini ø cm.10

12012x10 - 10 vetrini ø cm.12

12018x6 - 6 vetrini ø cm.14

12019x6 - 6 vetrini ø cm.16



Predisegni

Disegni semplici dai contorni ben delineati, ideali per decorare vetri, plastovetro, finestre, ecc.

04336

predisegni per plastovetro cm.15x21
10 soggetti assortiti
(idonei per l'età scolare)



1641



1641

album cm.30x40 modelli per vetrate
16 fogli con 41 modelli diversi

FOGLIO CM.44X120 H CON PREDISegni

04647x12

12 soggetti pasquali

04648x12

12 soggetti natalizi

04649x12

12 animali assortiti

04650x12

12 soggetti assortiti
(animali, personaggi e tanti
altri soggetti di fantasia)

04657

set 4 fogli soggetti assortiti



Film da decorare

Consentono di decorare le finestre e molte altre superfici senza rovinarle. Fabbricati con una particolare plastica pesante che costituisce un ottimo supporto per i colori acrilici e può essere tagliata con facilità. È sufficiente scegliere un disegno, posizionarlo sotto al foglio trasparente e tracciarne i contorni con gli appositi colori per contorni. Sono particolarmente consigliati colori trasparenti e Glass.



04656

rotolo film pesante, cm.55x3,5 mt.
spessore 15/100

1629/1

confezione 10 fogli film trasparente
dimensioni: cm.28x32

06260

confezione 6 fogli film trasparente
pesante dimensioni: cm.23x33



04598

busta 10 Window Foil
dimensioni: cm.29,7x42

04668

busta 10 Window Foil
dimensioni: cm.21x29,7



164 Materiale creativo

Plastovetro semi-rigido crilex

Plastovetro fabbricato in materiale acrilico. Pur mantenendo la trasparenza e la lucentezza tipiche del vetro ha il vantaggio di essere infrangibile e di possedere una discreta flessibilità, ampliando così le possibilità di utilizzo didattico, hobbistico, per vetrinisti ecc. Il materiale plastico supporta perfettamente colle, colori e altri materiali.

TRASPARENTE
INFRANGIBILE
MULTIUSO



- 07213** - cm.35x50 spessore: 11/10
- 07214** - cm.50x70 spessore: 11/10
- 07215** - cm.70x100 spessore: 11/10

Plastovetro flex

Un materiale versatile che si presta perfettamente a molteplici utilizzi: coreografie, scenografie, vetrinistica, didattica, grafica... Flessibile, antiscaglia, ideale anche per gli esterni: mantiene tutte le caratteristiche del vetro (trasparenza, decorabilità, resistenza) ma non è pericoloso, ed è quindi indicato anche per i bambini. Può essere colorato con colori trasparenti o marker permanenti.

materiale
molto flessibile



05348x6

6 plastovetri
cm.35x50 spessore: 35/100

05349x6

6 plastovetri
cm.50x70 spessore: 35/100

05350

cm.70x100 spessore: 35/100

Fogli adesivi trasparenti rimovibili

Ideali per lavori su carta ma specialmente su vetro in quanto consentono di ottenere particolari effetti di luce grazie alla trasparenza dei fogli. Perfetti per insegnare ai bambini i concetti di quadricromia.

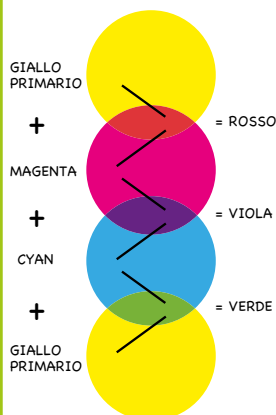

08921

set 6 fogli cm.21x29,7
adesivo trasparente rimovibile per vetro
fogli: 2 cyan, 2 magenta, 2 gialli

pag.347
palette esacromiche

Set suncatcher

Set contenente 29 diversi soggetti predisegnati su plastica trasparente e dai contorni ben delineati a rilievo. Ideale anche per i più piccoli! Il set include anche della polvere di ceramica che, mescolata ad acqua, può essere colata nei Suncatcher per realizzare simpatiche targhette decorative da dipingere.

08417

set 29 suncatcher da colorare
soggetti e misure assortiti



Supporti in cotone da decorare



COLORE ECRU'

11412x5

5 borse IN COTONE grandi
cm.37x41 h - manico corto



● **11417x5**

5 cappellini con visiera
IN COTONE (anche per bambini)



11414

grembiule IN COTONE cm.88x58 h
bordato blu - ADULTO



11418x10

10 borse in TNT
(tessuto non tessuto)
cm.38x42 h manico lungo



● **11416x5**

5 cappelli da cuoco
in TNT - ADULTO



11415x5

5 grembiuli in TNT
cm.60x90 h - ADULTO



12565

zainetto in TNT cm.29x25
da dipingere completo
di 4 marker



Gomma Crepp

La **Gomma Crepp** è un materiale detto anche "EVA", morbido al tatto ma molto resistente. Facile da tagliare e incollare, la Gomma Crepp è un valido e originale prodotto per realizzare lavoretti didattici e decorazioni.



GOMMA CREPP

- 1662** - set 10 fogli cm.15x20 colori assortiti
- 04754** - set 10 fogli cm.20x30 colori assortiti
- 04755** - set 10 fogli cm.30x50 colori assortiti
- 11326** - set 10 fogli cm.50x66 colori assortiti
- 12474** - set 5 fogli cm.50x66 colori assortiti
(assortimento colori base didattici: giallo rosso verde blu bianco)



GOMMA CREPP GLITTER

- 12377**
busta 10 fogli cm.20x30 colori assortiti
- 12472**
set 5 fogli cm.20x30 colori Natale assortiti
- 12473 GRANDE FORMATO!**
set 5 fogli cm.50x66 colori Natale assortiti
- 10401**
busta 10 fogli **ADESIVI** cm.20x30 colori assortiti

12376

Gomma Crepp **GLITTER ADESIVA**
busta 44 pezzi forme e colori assortiti

44
PEZZI
ADESIVI



IDEALE PER LAVORI
DI SCRAPBOOKING



Decorati in EVA

Soffici sagome in Gomma Crepp, assortite in tanti simpatici soggetti. Possono essere incollate con facilità per impreziosire disegni, lavoretti, oggetti vari...



NOVITA'

250
PEZZI

12912

forme in EVA "Primavera Mix" (250 pezzi)
colori assortiti
dimensioni: mm.15-40 circa



NOVITA'

425
PEZZI

12913

forme in EVA "Fiori" (425 pezzi)
colori assortiti
dimensioni: mm.20-45 circa



NOVITA'

250
PEZZI

12914

forme in EVA "Mezzi di trasporto" (250 pezzi)
colori assortiti
dimensioni: mm.15-40 circa

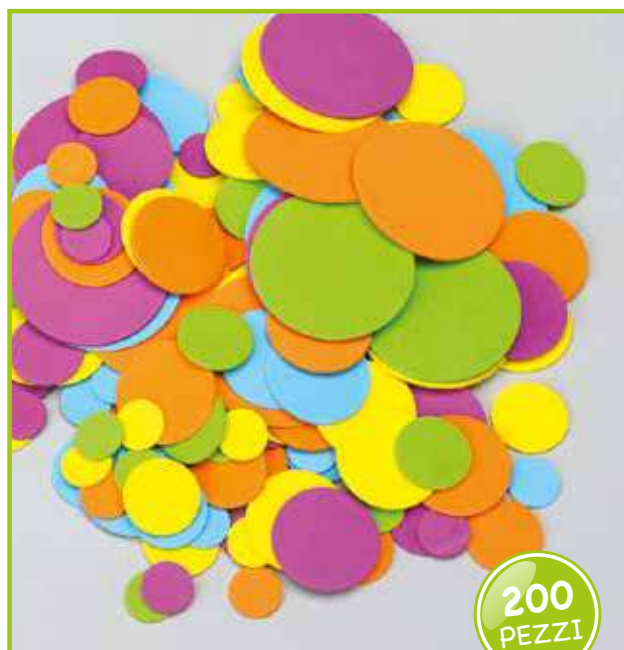

200
PEZZI

11458

set 200 cerchi in Gomma Crepp

Decorati in EVA

Soffici sagome in Gomma Crepp, assortite in tanti simpatici soggetti. Possono essere incollate con facilità per impreziosire disegni, lavoretti, oggetti vari...



da **04322x4** a **04331x4**

conf. 4 buste decori in Gomma Crepp forme e colori assortiti



04322x4
160 fiori



04323x4
400 stelle



04324x4
128 cuori



04325x4
360 numeri



04326x4
312 lettere



04327x4
160 frutti



04328x4
128 animali



04329x4
128 animali mare



04330x4
200 forme



04331x4
320 cerchi

07101

busta 50 sagome soggetti assortiti



03629

scatola timbri soggetti assortiti + 2 basi/impugnature



● **03742**

kit "Crea la tua borsa"
Il set contiene tutto l'occorrente per realizzare una borsetta in soffice Gomma Crepp in modo facile e divertente



FM967C

set 20 sagome animali assortiti

Decorati in EVA

ADESIVA

72
PEZZI
ADESIVI

11459

set 72 insetti **ADESIVE** in Gomma Crepp



405
LETTERE
ADESIVE

11460

set 405 lettere **ADESIVE** in Gomma Crepp



12915

lettere e numeri in EVA **ADESIVI** (1000 pezzi)
colori assortiti
dimensioni: mm.22 h circa

1000
PEZZI

170 Materiale creativo

500
PEZZI

12607

animali in EVA **ADESIVI** (500 pezzi)
colori e animali assortiti
dimensioni: mm.20-50



NOVITA'

Decorati in EVA

ADESIVA



132
STELLE
ADESIVE

NOVITA'

12927

set 4 fogli stelle in EVA GLITTER **ADESIVE** (132 pezzi)
dimensioni stella: da 15 a 34mm.
foglio mm.100x200 - 4 FOGLI (2 oro, 2 argento)



cm.4x5



03631

busta 2 fogli cm.16,5x25 44 decori **ADESIVI**
rimovibili per realizzare timbri, addobbi e
decorazioni. mela: cm.4x5



05021
numeri



05023
verdura



05024
animali



05025
animali marini

05021

set 3 fogli in Gomma Crepp **ADESIVA**
cm.9x15

da 05023 a 05030

set 3 fogli in Gomma Crepp **ADESIVA**
cm.9x15



05026
animali zoo



05027
frutta



05028
veicoli



05029
fiori



05030
uccelli

Feltro

Il feltro è un materiale composto da fibre di lana pressate. Per la sua resistenza è molto utilizzato per realizzare abiti per bambole, burattini e tanti altri oggetti!



pag.238
ovatta per imbottitura

pag.272
velcro adesivo



07653

set 10 feltri cm.21x30
colori assortiti

07652

set 10 feltri **ADESIVI**
cm.21x30 colori assortiti



NOVITA'

12917

set 54 feltri cm.20x30 - 18 colori assortiti
PACK SCUOLA

Feltro ad alto spessore

FELTRO ADESIVO gr.350/mq.







08765

cm.35x105 h spessore mm.2,2 - rosso



FELTRO gr.350/mq.
spessore mm.2,2
cm.105 h
vendita a metratura

ROTOLO FELTRO gr.350/mq.
spessore mm.2,2
cm.35 x 105 h

| | | | |
|--------------|--------------|---|--------------|
| | 08321 |  | Nero |
| 08332 | 08322 |  | Giallo |
| 08333 | 08323 |  | Rosso |
| | 08325 |  | Beige |
| 08336 | 08326 |  | Bianco |
| 08337 | 08327 |  | Verde scuro |
| | 08328 |  | Verde chiaro |
| | 08329 |  | Blu |
| | 08330 |  | Celeste |
| 11605 | 11606 |  | Grigio |



Decorati in feltro sagomato



08664
4 cuori cm.10x10



08665
4 cuori ø cm.14



08666
4 cerchi ø cm.16



08667
4 stelle ø cm.20



08668
4 fiori ø cm.20



08669
2 stelle cm.23



08670
2 gnomi cm.23x18



08663
6 soggetti natalizi
(alberello cm.5 h)



10834
8 fiori assortiti
(cm.3 e cm.6)



10835
8 stelle (da cm.6,5 a cm.10)



10836
8 stelle (da cm.4 a cm.8)



Decorati feltro/velcro

Sagome in feltro dotate di pratico velcro per attaccarle e staccarle con facilità.



08784
set 10 decori in feltro con velcro
stacca/attacca - soggetti natalizi



08719
set 14 decori in feltro con
velcro stacca/attacca
animali assortiti

Politex TNT (tessuto non tessuto)

Prodotto resistente allo strappo, non si sfilaccia e non si deteriora. Indicato per addobbi, abitini, realizzazione di pupazzi e decorazioni.

- Resistente alla cucitura e allo strappo
- Compatibile per venire a contatto con gli alimenti
- Fisiologicamente inerte
- Saldabile per mezzo di ultrasuoni o microonde









10134

POLITEX foglio cm.30x50 - 6 colori assortiti

da 10143 a 10148

POLITEX rotolo cm.150 h vendita al metro lineare

| | | |
|--------------|---|-------------|
| 10143 |  | Bianco |
| 10144 |  | Giallo |
| 10145 |  | Verde prato |
| 10146 |  | Rosa |
| 10147 |  | Rosso |
| 10148 |  | Blu |



**RESISTENTE
E DAI COLORI
BRILLANTI**

**IDEALE PER REALIZZARE
DECORAZIONI, SCENOGRAFIE
E ALLESTIMENTI**



10837

36 stelle misure ass. da cm.6,5 a cm.10

11336

12 stelle cm.20

11337 12 stelle ø

cm.23

11338

12 gnomi cm.18x23

11339

12 cuori cm.14

11340

12 stelle cm.14

Tela juta

Grazie al suo aspetto grezzo e naturale la tela juta è indicata per creare biglietti augurali, scatole, menù, confezioni regalo, pupazzetti, ecc...



IDEALE PER LAVORI
DI SCRAPBOOKING



pag.210
spago



12247

busta 6 pezzi cm.23x33 - colore naturale

2162 - GRANDE FORMATO!

pezza tela juta cm.140x200 - colore naturale



05541

set 10 pezzi cm.20x30 colori assortiti

2160

busta 10 pezzi cm.35x46 colori assortiti

● **2161 - GRANDE FORMATO!**

set 5 pezzi cm.50x140 colori assortiti

Carta panno

Carta morbida e resistente, che riunisce in un unico prodotto le migliori caratteristiche di carta e tessuto: resistenza, duttilità, morbidezza.



05797

rotolo carta panno blu
mt.5x120 cm. h.gr.60/mq

EFFETTO
SOFT TOUCH

INDICATA PER REALIZZARE
COSTUMI, PICCOLE DECORAZIONI
E COME TOVAGLIA!



Panno lana

Il panno lana oltre a mantenere le stesse caratteristiche del feltro si presenta ancor più morbido e sottile.











PANNO LANA colori assortiti

1570 - album 10 pezze cm.15x20

1571 - album 10 pezze cm.20x30

PANNO LANA
PEZZA cm.50x180

PANNO LANA
PEZZA cm.45x90

| | | | |
|----------------|----------------|---|---------|
| 1572/01 | 1575/01 |  | Rosso |
| 1572/02 | 1575/02 |  | Verde |
| 1572/03 | 1575/03 |  | Giallo |
| 1572/04 | 1575/04 |  | Blu |
| 1572/05 | 1575/05 |  | Rosa |
| 1572/06 | 1575/06 |  | Marrone |
| 1572/07 | 1575/07 |  | Bianco |
| 1572/08 | 1575/08 |  | Nero |
| 1572/09 | 1575/09 |  | Arancio |
| 1572/10 | 1575/10 |  | Azzurro |









Ecopelle

Tessuto sintetico, perfetta imitazione della pelle. Si tratta di un tessuto di poliestere con una copertura in cloruro di polivinile. Il materiale è molto morbido, flessibile e piacevole al tatto. I vantaggi principali sono, tuttavia, la resistenza all'abrasione e alla deformazione, elevata durata. Ecopelle è il materiale ideale per realizzare oggetti di abbigliamento e oggettistica.



ECOPELLE PEZZA cm.50x70 unicolore

| | | |
|--------------|---|---------|
| 11850 |  | Giallo |
| 11851 |  | Arancio |
| 11852 |  | Rosa |
| 11853 |  | Rosso |
| 11854 |  | Verde |
| 11855 |  | Blu |

11856

set 6 pezze cm.17,5x25 (cad.) colori assortiti

IDEALE PER REALIZZARE
MASCHERE E COSTUMI



176 Materiale creativo

Sagome fustellate canneté

Le sagome pretagliate si prestano a molteplici utilizzi: ideali per addobbare finestre, bacheche, pareti. Possono anche essere appese utilizzando del filo di nylon o utilizzate come chiudipacco per regali!!!



pag.191
occhietti decorativi



dimensioni cm.6x7

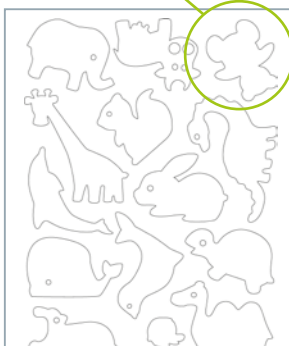

05408

confezione 4 fogli cm.23x33 - 56 animali assortiti



dimensioni cm.7,5x7,5

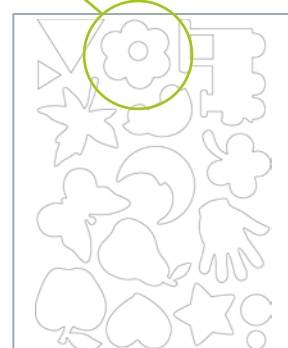

05409

confezione 4 fogli cm.23x33 - 48 forme assortite



dimensioni cm.6x8

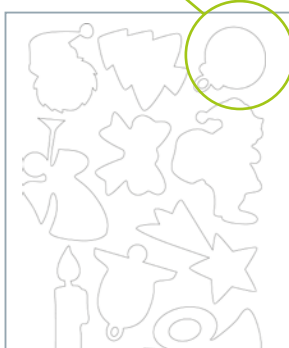

05003

confezione 4 fogli cm.23x33 - 40 forme natalizie assortite



03618

confezione 44 soggetti fustellati assortiti in canneté oro/argento fogli cm.14x20



07169

confezione 18 forme geometriche in canneté
dimensioni cerchio: \varnothing cm.13,5

Decorati in sughero



esempio

06729

set albero da decorare in sughero
spessore mm.4, altezza cm.26,5 + 2 basi

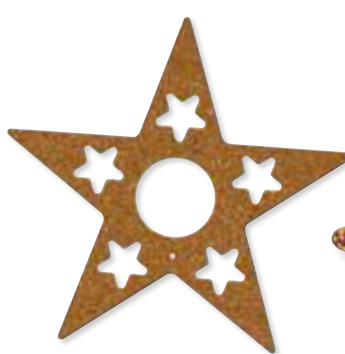

esempio



08052

busta 2 stelle in sughero cm.16x16

Dekò cuore



07158

set "Effetto cuore"
contiene: 6 basi in materiale acrilico a forma di cuore cm.17x17 con gancino per appenderla, 6 cuori in cartoncino colore rosso/oro

07145

Dekò cuore set da decorare cm.17x17
Contiene: 1 base rossa a forma di cuore in materiale acrilico, 1 specchio infrangibile a forma di cuore, 1 cuore in cartoncino, 1 cuore in sughero con foro, 1 cuore in canneté con foro

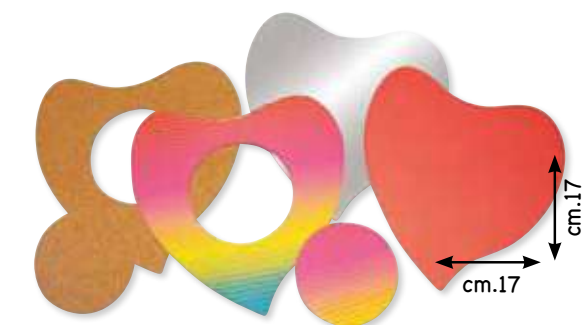

07153x6

6 cuori in specchio
infrangibile cm.14x14

07156x10

10 cuori in cartoncino
rosso/oro cm.14x14

07154x6

6 cuori in sughero
con foro cm.14x14

07155x6

6 cuori in canneté
con foro cm.14x14

● **07157**

busta 12 cuoricini cm.7x7, contiene: 3 specchi infrangibili a cuore, 3 cuori in sughero con foro, 3 cuori in canneté con foro, 3 cuori in cartoncino rosso/oro

Decori in sughero

Originali sagome dalle forme assortite che potranno essere decorate a piacere dai bambini per poi impreziosire ogni tipo di oggetto, disegno, collage, biglietto... Le forme sono pretagliate, quindi non è necessario l'utilizzo di forbici.

GRANDEZZA
NATURALE
CM.6x8



06760

set 14 animali
+ 20 occhietti adesivi



06761

set 16 sagome
soggetti assortiti



06762

set 10 sagome natalizie



07109

set 40 sagome
soggetti assortiti



● **07110**

set 22 sagome
soggetti assortiti

Decorati in sughero

Ideali anche come base per svariate tecniche: découpage, doratura, pirografia... Decorabili con ogni colore e materiale.



04889x5

5 stelle doppie
ø cm.20 spess. mm.4



04893x5

5 cuori doppi
ø cm.14 spess. mm.6



1154x12

12 tondi ø cm.9
spess. mm.4

04888x5

5 tondi ø cm.16
spess. mm.6

04887x5

5 tondi ø cm.20
spess. mm.6

1155x5

5 tondi ø cm.28,5
spess. mm.4



04890x5

5 stelle a 7 punte
ø cm.20 spess. mm.6



04891x5

5 fiori ø cm.20
spess. mm.6



04892x5

5 cuori ø cm.18
spess. mm.6



04894x5

5 ovali cm.14x20
spess. mm.6

Decorati in sughero e cartone



08053



08054



08055



08056

08053

busta 1 lastra sughero
cm.25x25 + stella in canneté

08054

busta 1 lastra sughero
cm.20x30 + gnomo in canneté

08055

busta 1 lastra sughero
cm.20x30 + foglia in canneté

08056

busta 1 lastra sughero
cm.20x30 + cavallo in canneté

Sottopentola in legno e sughero

Originale sottopentola che può essere decorato utilizzando le tecniche più svariate: découpage con carta o tovaglioli, pirografia, stenciling, pittura con colori acrilici. Il sughero supporta egregiamente ogni tipo di materiale o collante.

esempio sottopentola
pirografato



08089

sottopentola cm.23 - soggetto: foglia

08090

sottopentola cm.23 - soggetto: gnomo

08091

sottopentola cm.20 - soggetto: albero

08092

sottopentola cm.17 - soggetto: cavallo



08089



08090



08091



08092

Sughero per lavori didattici

Facile da decorare con colori acrilici, tempere, carta e tovaglioli *découpage*, pirografia...



1150

rotolo mt.10x50 cm. h spessore mm.2

1152

rotolo mt.8x50 cm. h spessore mm.4



1153x10

10 lastre cm.30x30x4 mm.

05699x9

9 lastre cm.50x100x4 mm.

05700x6

6 lastre cm.50x100x6 mm.

CREA LA TUA
BACHECA
IN SUGHERO



IDEALE
PER GIOCHI
CREATIVI E
DIDATTICI



07100

busta sagome in sughero
50 pezzi circa - soggetti assortiti



07111

busta 25 tessere mosaico
in sughero da decorare
tessera cm.1,5x1,5 - spess. mm.4

CREA DEI
SIMPATICI
TIMBRI E LIBERA
LA FANTASIA



1159

50 tappi in sughero
dimensioni: ø mm.28x40 h



1151

set didattico da decorare
contiene: 10 tovagliette
all'americana cm.25x36,
10 sottobicchieri, 1 stencil

CREA
DEI FANTASTICI
SOTTOBICCHIERI



Decor in legno

Facili da decorare anche dai più piccoli, queste sagome possono essere usate per impreziosire ogni oggetto, lavaretto, disegno... Supportano egregiamente colori e collanti.



pag.87
vernice lavagna
e vernice lavagna
magnetica



08648
busta 2 stelle mm.105



08649
busta 3 stelle mm.80



08650
busta 5 stelle mm.40



08651
12 stelle da mm.15 a 25

TESTA IN LEGNO

07161x6

6 teste in legno - \varnothing cm.4,8



BUSTA 12 PIEDINI IN LEGNO

08791 - mm.22x34

08792 - mm.28x45

08793 - mm.35x55



Base in betulla

Ideale come piedistallo per creazioni tridimensionali.



08979x4

4 basi multistrato in betulla
cm.10x18x1,8



GRANDEZZA
NATURALE

PERLA \varnothing mm.50



BUSTA PERLE IN LEGNO FORATE

06307 - \varnothing mm.50 - 2 pezzi

05859 - \varnothing mm.35 - 3 pezzi

05860 - \varnothing mm.30 - 4 pezzi

05861 - \varnothing mm.25 - 6 pezzi

05862 - \varnothing mm.20 - 10 pezzi

05863 - \varnothing mm.15 - 15 pezzi

05864 - \varnothing mm.10 - 35 pezzi

05865 - \varnothing mm.8 - 100 pezzi

05866 - \varnothing mm.6 - 140 pezzi

05867 - \varnothing mm.4 - 180 pezzi

Decorati in legno forati

05868

busta 7 croci forate
da cm.1,5x2,5 a cm.3,5x5,5

05869

busta 12 sagome soggetti assortiti
forati fiore: cm.7x7

05870

busta 4 sagome soggetti: tondi forati
ø cm.4 e ø cm.5

05871

busta 12 sagome soggetti assortiti
forati fiore: cm.3x3

05872

busta 24 sagome assortite
stella: cm.3x3

05873

busta 100 sagome assortite
dimensioni assortite



05868



05869



05870



05871



05872



05873



06383x6

6 buste da 30 perle barilotto
cm.0,8x1

180
PEZZI



06383x6

180
PEZZI



06384x6

06384x6

6 buste da 30 perle coniche
cm.1x1,2

180
PEZZI



06385x6

240
PEZZI



06387x6

06385x6

6 buste da 30 perle cilindriche
cm.0,7x2,2

06387x6

6 buste da 40 perle
ø cm.0,4-0,6-0,8-1

180
PEZZI



06389x6

450
PEZZI



06390x6

06389x6

6 buste da 30 perle cilindriche
cm.1-1,5-2

06390x6

6 buste da 75 perle e microperle
dimensioni assortite

600
PEZZI



06391x6



06386

06391x6

6 buste da 100 microperle
dimensioni assortite

06386

busta 30 dischi forati cm.0,6x1,5

07077

busta 40 perle cilindriche legno

07078

busta 40 perle tonde legno chiaro

07079

busta 40 perle tonde legno "Cina"



06386



07077



07078



07079

200
PEZZI



KD2019

barattolo 200 sagome
in legno - forme assortite



PERLE IN LEGNO FORME E
COLORI ASSORTITI
DA MM.6 A MM.20

R11697 - busta gr.70

Oggetti in legno

Un'ampia gamma di sagome e oggetti in legno naturale da dipingere e personalizzare con il supporto di tantissimi materiali (occhietti mobili, glitter, pompons, piume, gomma Crepp...) Perfetti per realizzare originalissimi lavoretti didattici!



10
PEZZI

12638

portauovo in legno (10 pezzi)
ø mm.42x65

Meccanismo per orologi

12651

meccanismo per orologi
con lancette mm.56x66x28



REALIZZA
IL TUO
OROLOGIO!



10
PEZZI

12639

tondo in MDF (10 pezzi) ø mm. 180 (foro 8 mm)

Il tondo può essere utilizzato per realizzare un originalissimo orologio!



10
PEZZI

12640

animali in legno con supporto (10 pezzi)
Lunghezza: mm.100-145 - Larghezza: mm. 60-100



300
PEZZI

12641

lettere in legno (300 pezzi)
Altezza: mm.20-27 - Larghezza: mm.8-21



100
PEZZI

12642

cuori di legno (100 pezzi)
colore naturale
dimensioni: mm.30, 40, 50



VISTA LATERALE

dischi bombati di legno

12644/1

100 pezzi ø mm.30

12644/2

50 pezzi ø mm.60



12643

farfalle e fiori di legno (12 pezzi)
farfalla mm.90x60
fiore mm.90x90

Pigne e fette di albero

Pigne e fette di legno naturale ideali per realizzare lavoretti e decorazioni. Facili da dipingere, supportano perfettamente le colle (vinilica, colla a caldo ecc.) Le fette possono anche essere pirografate!



12
PEZZI

12631
pigne (12 pezzi) misure assortite

125
PEZZI

12632
pigne (125 pezzi)
misure assortite PACK SCUOLA



TT101
busta 100 fette di albero
misure assortite da mm.10 a 30



12634
fette di albero (7 pezzi)
mm.160x80 circa

12633
fette di betulla (140 pezzi) ø mm.25-45

Bastoncini in legno naturale perfetti per realizzare lavoretti e decorazioni. Possono essere dipinti e incollati con facilità.



650
PEZZI

12635
bastoncini di legno
(650 pezzi) colore naturale
dimensioni: mm.86x3x3

20
PEZZI

12637
sfere di legno con **visi espressivi**
colore naturale (20 pezzi)
dimensioni: ø mm.30

12636
bastoncini di legno (50 pezzi)
colore naturale
dimensioni: cm.40x4 mm. ø
Ideali per fiori e girandole.



50
PEZZI



Stick in legno



1718x12

12 set da 50 stecche in legno
cm.1x11,5

11690

busta 50 stecche in legno
cm.1,8x15



GRANDEZZA REALE

1718

11690

Stick in legno colorato



200
PEZZI

KD1029

barattolo 200 stecche tonde
cm.10 colori assortiti



100
PEZZI

KD1015

set 100 stick incastrabili cm.1x11,5
in legno naturale colori assortiti



100
PEZZI

KD1031

barattolo 50 stick forati cm.1,9x10
+ 50 bastoncini tondi cm.15 colori ass.



25
PEZZI

1717/25

set 25 stick in **plastica antiurto**
cm.1x11,5 colori assortiti

Mollette



BUSTA 45 MOLLETTE IN LEGNO - mm.25

12023 - colori neon



BUSTA 45 MOLLETTE IN LEGNO - MM.25

12024 - colori pastello



BUSTA 50 MOLLETTE IN LEGNO

11687 - mm.25x3
11688 - mm.45x7
11689 - mm.72x10



BUSTA 100 MEZZE MOLLETTE

1735 - cm.2,5
1736 - cm.4,5
1719 - cm.7,2



Bottoni in legno



BUSTA 30 BOTTONI IN LEGNO

12025
 dimensioni assortite
 (ø mm.8-10-15-20)
 colore naturale



BUSTA 30 BOTTONI IN LEGNO

12026
 dimensioni assortite
 (ø mm.8-10-15-20)
 colori classici



BUSTA 30 BOTTONI IN LEGNO

12027
 dimensioni assortite
 (ø mm.8-10-15-20)
 colore neon



BUSTA 30 BOTTONI IN LEGNO

12028
 dimensioni assortite
 (ø mm.8-10-15-20)
 colori pastello

Bottoni in plastica



650
PEZZI

BUSTA 650 BOTTONI IN PLASTICA

12029
 gr.500 assortiti
 SPECIALE SCUOLA



Sonagli e campanelli



11491

busta 10 campanelle (mm.22x24)



11490

busta 10 sonagli (mm.14,5x17)

Oggetti decorativi

Un grande assortimento di sagome e oggetti coloratissimi, ideali per personalizzare qualsiasi creazione e renderla unica!



96
PEZZI

12608

cappellini di plastica (96 pezzi)
colori e forme assortite

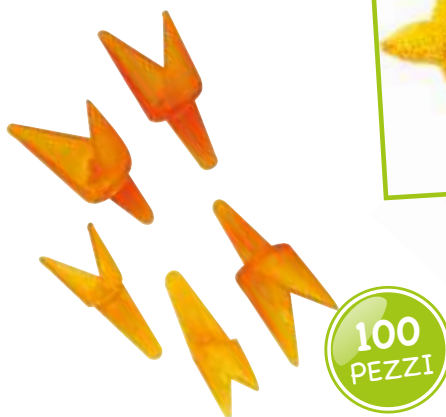

100
PEZZI

12610

becchi di plastica per pulcini (100 pezzi)
dimensioni: mm.31x15 cad.



25
COPPIE

12611

zampe di plastica per pulcini (25 coppie)
dimensioni: mm.25x31x22 h

Gemme Kristall



1000
PEZZI

12619

gemme kristall tonde
circa 1000 pezzi - colori assortiti
dimensioni: \varnothing 6-10 mm



250
PEZZI

12620

gemme kristall mix
circa 250 pezzi - forme e colori assortiti
dimensioni: \varnothing 15-20 mm



ADESIVE

2150
PEZZI

12621

gemme kristall **ADESIVE**
circa 2150 stick - forme: luna, cuore,
cerchio, stella e rombo - \varnothing mm.8

Pompons

I pompons sono ideali per decorare le forme di cellulosa e polistirolo, ma anche per costruire morbidi pupazzetti, realizzare simpatici addobbi, dare un tocco di originalità a disegni e collage...



QUALITA'
EXTRA
MORBIDI E
DELICATI

POMPONS LAME' misure assortite
da \varnothing mm.7 a \varnothing mm.28

- 6241 - busta 100 pompons colori assortiti
- 10961 - busta 40 pompons colori assortiti
- 10962 - busta 40 pompons oro/argento



100
PEZZI

- 12612 pompons (100 pezzi) \varnothing mm.10-35
mix di colori manto degli animali



POMPONS misure assortite
da \varnothing mm.13 a \varnothing mm.50

- 6240 - busta 100 pompons colori assortiti
- 10959 - busta 40 pompons colori assortiti
- 10960 - busta 40 pompons bianchi
- 11316 - busta 40 pompons gialli

NOVITA'

POMPONS misure assortite
da \varnothing mm.15 a \varnothing mm.30

- 12933 busta 100 pompons
colori primavera assortiti



100
PEZZI

- 12613 pompons (100 pezzi) \varnothing mm.10-35
mix di fantastici colori a strisce



Dischetti per pompons

Cartoncini già pronti all'uso per creare fantastici pompons utilizzando della lana.



08543

confezione 70 dischetti
in cartone ø cm.8



NOVITA'

12916

set 4 telai per
creare i pompons

Creare pompons non è mai stato così semplice grazie ai telai crea pompons! Servono solo lana, forbici e uno dei 4 telai inclusi nel set e assortiti in varie dimensioni. Istruzioni nella confezione.



Ciniglia



1705/G

confezione 30 fili assortiti in 10 colori
ciniglia dritta, stelo grosso
lunghezza cm.30 - ø mm.9

30
PEZZI



1705/N

confezione 25 fili assortiti in 4 colori
ciniglia dritta in lamé brillante
lunghezza cm.30 - ø mm.6

25
PEZZI

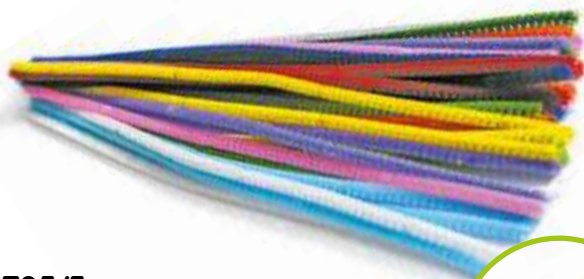

1705/F

confezione 30 fili assortiti in 10 colori
ciniglia dritta, stelo fine
lunghezza cm.30 - ø mm.6

30
PEZZI



1705/E

confezione 10 fili assortiti in 10 colori
ciniglia sagomata a elica
lunghezza cm.30x4 eliche

10
PEZZI

Set creatività



550
PEZZI

12618

craft set (550 pezzi) contenuto: 5 fogli morbidi IN EVA, 100 pompon, 30 occhi, 50 scovolini, 250 forme morbide, 115 animali in EVA

12617

craft box (750 pezzi) contenuto: 30 Portachivi ø mm.25, occhi con ciglia, 48 cappelli in plastica, 50 fili di ciniglia colorati, 100 pompon Neon, elastico 25 mt. bianco, piume assortite, 400 perle assortite



SET
EXTRA
LARGE

750
PEZZI

Piume



100
PEZZI

12609

piume tropicali (100 pezzi)
dimensioni: da mm.50 a 100

800
PEZZI

05756

busta gr.10 (pezzi 80 circa) cm.15/16

05755 - SPECIALE SCUOLA

busta gr.100 (pezzi 800 circa) cm.15/16

DIPINGI E DECORA
SECONDO LA TUA
IMMAGINAZIONE E
RIEMPI LE SCATOLE CON
PICCOLI OGGETTI.



50
PEZZI

12616

scatole fiammiferi (50 pezzi)
in cartone bianco
cm.5,5x3,5x1,5

190 Materiale creativo

Occhi mobili

Occhietti adesivi con iride mobile, per realizzare e personalizzare pupazzi, burattini, animali bidimensionali e tridimensionali o per dare un tocco in più a disegni ecc...



BUSTA 100 OCCHI ADESIVI OVALI

08780 - mm.5x7

08781 - mm.7x9

08782 - mm.10x12

08783 - mm.14x18

BUSTA 50 OCCHI ADESIVI OVALI

11496

misure assortite



BUSTA 100 OCCHI ADESIVI TONDI

940/5 - ø mm.5

940/7 - ø mm.7

940/12 - ø mm.12

940/20 - ø mm.20

BUSTA 50 OCCHI ADESIVI TONDI

11495

misure assortite



SPECIALE SCUOLA

BUSTA 200 OCCHI ADESIVI TONDI/OVALI MISURE ASSORTITE

11494 - misure assortite



12614

occhi espressivi con ciglia e pupille
in movimento (230 pezzi) **SPECIALE SCUOLA**
colori assortiti - ø mm.7-10



12615

occhi con iridi colorate
in movimento (600 pezzi) **SPECIALE SCUOLA**
colori assortiti - ø mm.5-7

Washi tape - nastro in carta

I Washi tape sono nastri adesivi in carta giapponese che possono essere utilizzati per rivestire qualsiasi superficie: dalle pareti al vetro, dalla carta al legno! Molto indicati per lavoretti didattici e di scrapbooking, aderiscono facilmente alle superfici, anche quelle tondeggianti. Possono essere attaccati e staccati innumerevoli volte, e non lasciano segni sulle superfici.



12646

Assortimento "Tonalità"
set washi tape (14 pezzi)
dimensioni mt.5x15 mm
colore: verde, verde lime, giallo, arancione,
rosso, indaco, rosa, viola chiaro, viola,
blu scuro, azzurro, grigio, nero, bianco



SET WASHI TAPE (6 PEZZI) DIMENSIONI: MT.3x15 MM

12647/1

Assortimento "Broadway" colore: bianco e nero

12647/2

Assortimento "Cromo" colore: oro, rame, argento

12647/3

Assortimento "Scintille" colore (glitter): argento, oro,
verde, rosa, viola, blu

* I disegni potrebbero variare in base alle mode

Nastri di raso

Gli eleganti nastri di raso sono perfetti per chiudere pacchi regalo, impreziosire biglietti d'auguri e scatole, ma anche per realizzare lavoretti e decorazioni, lavori di scrapboking ecc.



12650

nastri di raso (6 pezzi)
colore: rosso e bianco assortiti
dimensioni mt.1x9/15 mm



Tessuti fantasia

INDICATI PER LAVORI DI SCRAPBOOKING!!



**48
PEZZI**

ASSORTIMENTO "TEXTURE DELLE STOFFE"

● **12629**

tessuti 48 pezzi cm.20x30
colori e fantasie assortite

Scopina scacciaguai

Allegra e simpatica questa scopina dovrebbe essere posta nell'ingresso della casa come scacciaguai, su una parete o appesa ad una porta.

1716x6

6 scopine scacciaguai
cm.18



Filati



10
PEZZI

12626

set 10 matasse **100% cotone** - Lunghezza: 30 mt (cad.)
Colore: bianco, giallo, arancione, rosso, viola, rosa, blu,
verde chiaro, azzurro, nero

12627

set 10 matasse **100% acrilico** - Lunghezza: 36 mt (cad.)
Colore: bianco, giallo, arancione, rosso, viola, rosa, azzurro,
verde chiaro, verde, nero

6 PEZZI
8 METRI
CAD



MATASSINA 100% PURO COTONE

(6 pezzi) lunghezza: 8 mt (cad.)

12622/1

assortimento Natale (6 grad. di rosso)

12622/2

assortimento Autunno (6 grad. di marrone)

12622/3

assortimento Primavera (6 grad. di verde)

12622/4

assortimento Mare (6 grad. di blu)

Gomitolo 100% acrilico

11601/01

6 gomitoli gr.50 - mt.133 (cad.)
colore bianco

11396

6 gomitoli colori assortiti
100% acrilico gr.50 - mt.133 (cad.)



Telai

12628

telaio in legno
per mandala
telaio cm.23x23x3
+ ago

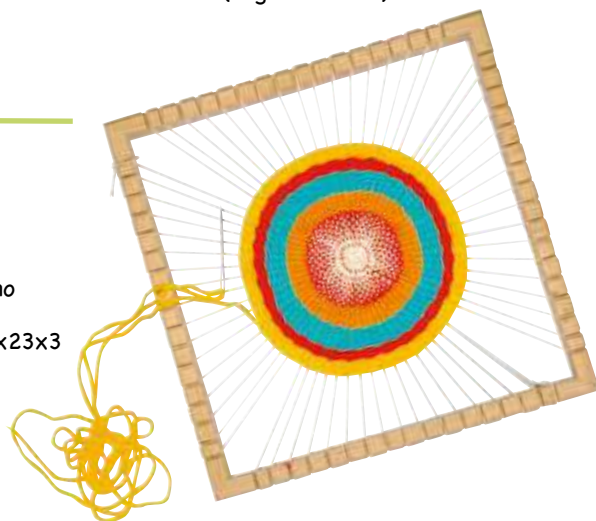

Aghi

DI SICUREZZA

09167

confezione 12 aghi in plastica
lunghezza cm.15 colori assortiti



Pettine

12630

pettini in plastica per tessitura
(5 pezzi) dimensioni: cm.20x6,5



58988

telaio in legno cm.22x19x4
+ 4 matassine di lana - età 6+



Perle in legno

NOVITA'

12919

perle in legno \varnothing mm.10/25
con cordoncino
(secchiello 150 pezzi)



Perle in plastica

Coloratissime perline assortite in tante forme originali, ideali per realizzare gioielli trendy e per impreziosire ogni oggetto: cornici portafoto, scarpe, abiti, zainetti, diari...

I giochi di infilatura aiutano a sviluppare capacità motorie, destrezza e coordinazione occhio-mano.

3600
PEZZI



NOVITA'

12910

perle in plastica da 9 a 12 mm.
cuori, stelle, fiori, perline, farfalle
(bauletto 3600 pezzi)

Pinzette in plastica

Maxi pinzette ideate appositamente per le manine dei bambini. Particolarmente indicate per i giochi di classificazione e seriazione, aiutano a sviluppare la coordinazione occhio-mano.



NOVITA'

12911

set 10 pinzette
in plastica per lavori creativi
10,1 x 2,3 cm

















Perle

Adatte per realizzare lavoretti originali, colorati e luminosi ma anche per esercizi di seriazione, infilatature ecc. **Dimensioni: cm.1x1 circa.**



da 947/1 a 947/14

barattolo ml.150 perle kristall unicolore - forme assortite

| | | | | | |
|--------------|---|-------------|---------------|---|---------------|
| 947/1 |  | Cristal | 947/8 |  | Verde chiaro |
| 947/2 |  | Azzurro | 947/9 |  | Verde fluo |
| 947/3 |  | Arancio | 947/10 |  | Rosa |
| 947/4 |  | Rosso | 947/11 |  | Oro |
| 947/5 |  | Becco d'oca | 947/12 |  | Argento |
| 947/6 |  | Violetto | 947/13 |  | Madreperla |
| 947/7 |  | Giallo | 947/14 |  | Ambra indiana |



06818

07115

06818
busta gr.40 perle kristall
forme e colori assortiti

● **07115**
scatolina gr.20 perle kristall
forme e colori assortiti



06819

948

06819
barattolo ml.700 perle kristall
forme e colori assortiti

948
barattolo ml.350 perle kristall
forme e colori assortiti + cordoncino



945
valigetta perle Kristall colori assortiti
+ cordoncino e clips



946
barattolo ml.350 perle coprenti
forme e colori assortiti + cordoncino



12047
tavolozza ø cm.20
+ 200 perle trasparenti

Perle Kristall

Perle trasparenti colorate e luminose. Adatte per realizzare originali braccialetti e collane. Aiutano a sviluppare la coordinazione visiva e motoria grazie a esercizi di infilatura. Perfette anche per esercizi di classificazione e insiemistica.

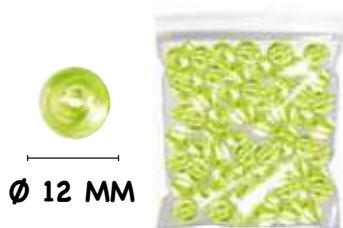

Ø 12 MM

da 11751/01 a 11751/07
busta 50 perle kristall unicolore

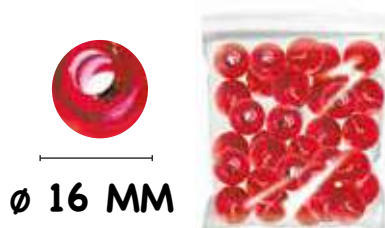

Ø 16 MM

da 11775/01 a 11775/07
busta 30 perle kristall unicolore

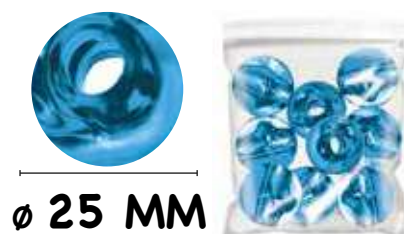

Ø 25 MM

da 07590 a 07595
busta 9 perle kristall unicolore



11834
barattolo 260 +/-
12 mm - colori assortiti

11797
barattolo 300 +/-
12 mm - colori assortiti



11835
barattolo 90 +/-
16 mm - colori assortiti

11798
barattolo 120 +/-
16 mm - colori assortiti

Perle Tahiti



box: cm.29x19 + cordoncino

11840

confezione 400 perle 12 mm - colori assortiti

11841

confezione 140 perle 16 mm - colori assortiti



box: cm.55x30

11842

confezione scuola 2100 perle 12 mm - colori assortiti

11843

confezione scuola 966 perle 16 mm - colori assortiti

Perle Tahiti

Perle coprenti in plastica pregiata assortite in 16 colori. Indicate per realizzare originali braccialetti e collane. Aiutano a sviluppare la coordinazione visiva e motoria grazie a esercizi di infilatura. Perfette anche per esercizi di classificazione e insiemistica.



pag.208
lacci in tessuto



Ø 12 MM

da 11751/10 a 11751/25
busta 50 perle Tahiti unicolore

| | |
|-------------------------|--|
| 11751/10 - Bianco | |
| 11751/11 - Bianco Perla | |
| 11751/12 - Giallo | |
| 11751/13 - Rosso | |
| 11751/14 - Arancio | |
| 11751/15 - Verde Chiaro | |
| 11751/16 - Verde Scuro | |
| 11751/17 - Blu | |
| 11751/18 - Azzurro | |
| 11751/19 - Rosa | |
| 11751/20 - Lilla | |
| 11751/21 - Nero | |
| 11751/22 - Oro | |
| 11751/23 - Marrone | |
| 11751/24 - Legno | |
| 11751/25 - Viola | |

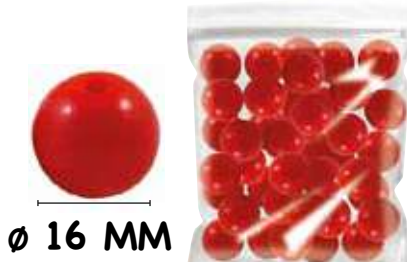

Ø 16 MM

da 11775/10 a 11775/25
busta 30 perle Tahiti unicolore

| | |
|-------------------------|--|
| 11775/10 - Bianco | |
| 11775/11 - Bianco Perla | |
| 11775/12 - Giallo | |
| 11775/13 - Rosso | |
| 11775/14 - Arancio | |
| 11775/15 - Verde Chiaro | |
| 11775/16 - Verde Scuro | |
| 11775/17 - Blu | |
| 11775/18 - Azzurro | |
| 11775/19 - Rosa | |
| 11775/20 - Lilla | |
| 11775/21 - Nero | |
| 11775/22 - Oro | |
| 11775/23 - Marrone | |
| 11775/24 - Legno | |
| 11775/25 - Viola | |



11836
valigetta 400 +/-
12 mm - colori assortiti
+ cordoncino



11837
valigetta 140 +/-
16 mm - colori assortiti
+ cordoncino



11838
confezione 180 +/-
12 mm - colori assortiti
box: Ø cm.20 + cordoncino



11839
confezione 72 +/-
16 mm - colori assortiti
box: Ø cm.20 + cordoncino

Cordoncino elastico



06344

cordoncino elastico
ø mm.1x3 mt

Pive



05587

confezione 12 flaconi ml.25 pive colori assortiti

Perline in acrilico

Perle in plastica, dalle forme originali e dai colori brillanti, con cui realizzare gioielli davvero unici, impreziosire indumenti, cuscini, scarpe e creare lavoretti didattici di grandissimo effetto!



07055

busta 20 perle cm.1
barilotto oro



07056

busta 20 perle cm.1
barilotto argento



07057

busta 20 perle cm.1
barilotto rosso



07058

busta 20 perle cm.1
barilotto blu



07059

busta 20 perle cm.1
cilindretti oro



07060

busta 20 perle cm.1
cilindretti argento



07061

busta 20 perle cm.1
cilindretti neri



07062

busta 20 perle cm.1
cilindretti rossi



07063

busta 20 perle goccia
oro



07064

busta 20 perle goccia
argento



07065

busta 20 perle goccia
azzurro



07066

busta 20 perle goccia
rosso



07067

busta 20 perle
allungate oro



07068

busta 20 perle
allungate argento



07069

busta 20 perle
allungate blu



07070

busta 20 perle
allungate nero

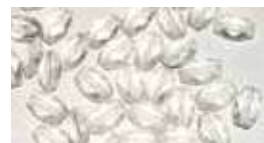

07071

busta 40 gemme
trasparente



07072

busta 40 gemme azzurro



07073

busta 40 gemme rosso



07074

busta 40 gemme rosa



07075

busta 20 stelle cm.1,8



07076

busta 20 cuori cm.2

COLORI ASSORTITI



Piatti, ciotole e contenitori



10560

vassoio cm.24x33 (interno formato A4) in plastica

10142

vassoio cm.28x36 in plastica

10561

vassoio cm.33x45 (interno formato A3) in plastica



08100

confezione 4 ciotole \varnothing cm.16

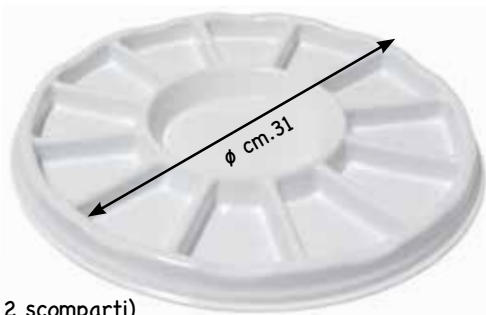

09692

vaschetta \varnothing cm.31 (12 scomparti)

09693

vaschetta \varnothing cm.31 (12 scomparti) con coperchio trasparente



190

vaschetta "sole" \varnothing cm.20 (9 scomparti)

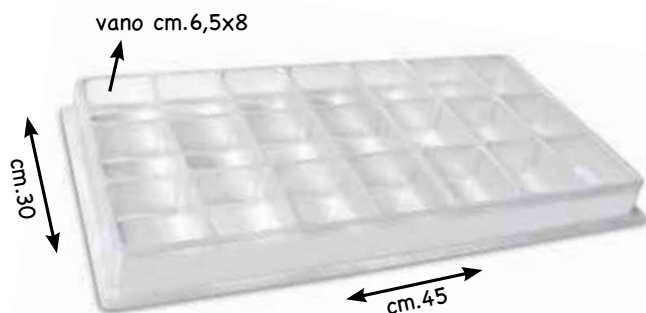

09404

vaschetta cm.30x55x5 h
con 21 vani cm.6,5x8

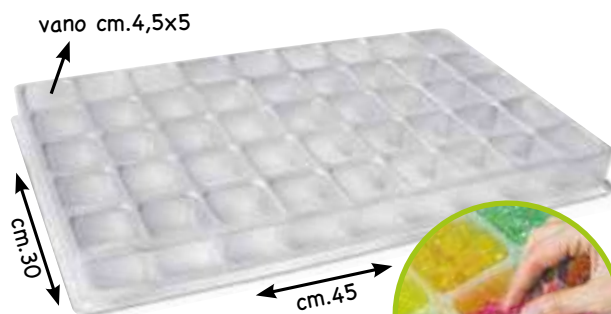

09405

vaschetta cm.30x55x5 h
con 45 vani cm.4,5x5





Colla glitter

Una serie di colle che contengono scintillanti glitter colorati. Con le penne Glitter Glue decorare ogni oggetto è semplicissimo!! Pratico beccuccio dosatore per una facile applicazione su qualsiasi superficie.



05883 a 07765

blister 6 penne ml.10,5 - unicolore

- | | | |
|--------------|---|---------|
| 05883 |  | Rosso |
| 05884 |  | Argento |
| 05885 |  | Oro |
| 07764 |  | Blu |
| 07765 |  | Verde |



COLLA GLITTER ML.52

da 10888 a 10890

flacone ml.52 - unicolore

- | | | |
|--------------|--|---------|
| 10888 |  | Rosso |
| 10889 |  | Argento |
| 10890 |  | Oro |

10891

confezione 12 flaconi ml.52 - colori assortiti



05882

blister 6 penne ml.10,5 colori assortiti

05887

PACK SCUOLA 30 penne ml.10,5
colori assortiti



11229

blister 6 penne ml.10,5 colori gel pastello assortiti







10887

PACK SCUOLA 30 penne ml.10,5
colori gel pastello assortiti

Glitter a grana grossa

da 10429 a 10434

barattolo ml.150 glitter a grana grossa

- 10429  Oro
- 10430  Argento
- 10431  Rosso
- 10432  Blu
- 10433  Verde
- 10434  Multicolor



GLITTER A GRANA GROSSA

08950 e 08951

barattolo con dosatore ml.150

- 08950  Oro
- 08951  Argento



GLITTER A GRANA GROSSA

05034

busta gr.80 colore oro

Stelline



05585

05586, 10956, 10957

SOGGETTI METALLIZZATI - FLACONE ml.25

- 05585 - soggetti assortiti
- 05586 - stelline colori assortiti
- 10956 - stelline colore oro
- 10957 - stelline colore argento



11452

dispenser 30 gr. stelline
in 4 colori assortiti

Glitter spray

Spray per far luccicare ogni superficie in modo omogeneo, pulito e pratico. L'effetto brillante è garantito su ogni superficie! Ideale anche su vetro!



da 07375 a 07377

flacone ml.100 glitter spray

- 07375 - Oro
- 07376 - Argento
- 07377 - Argento multicolor
(base argentata con glitter colorati)



09676

blister 6 flaconi (ml.12 cad.) stelline
colori assortiti flacone ø cm.1,2x9 h

05031

set 24 flaconi stelline metallizzate colori
assortiti (oro, argento, verde, rosso, blu)
flacone ø cm.1,2x9 h - ml.12

Glitter a grana fine

GLITTER A GRANA FINE FLACONE
 ø cm.1,2x9 h ml.12 circa

da 130/1/A a 130/1/VI
 flacone glitter unicolore

- 130/1/A**  Argento
- 130/1/B**  Blu
- 130/1/F**  Fuxia
- 130/1/I**  Iride
- 130/1/O**  Oro
- 130/1/R**  Rosso
- 130/1/RA**  Rame
- 130/1/T**  Turchese
- 130/1/V**  Verde
- 130/1/VI**  Viola
- 130/1/VE**  Verde acido



130/GL5

130/GL5

blister 6 flaconi colori assortiti



GLITTER A GRANA FINE

130/50

confezione SCUOLA
 50 flaconi colori assortiti



GLITTER A GRANA FINE PORPORINA
 Blister 3 flaconi ml.12

- 11591** - fluo
- 11592** - olografici
- 11593** - iridescenti



Tappo con doppia possibilità
 di erogazione

da 06655/1 a 06657/1

flacone glitter ml.25 circa - unicolore

- 06655/1**  Oro
- 06656/1**  Argento
- 06657/1**  Rosso



DISPENSER GLITTER A GRANA FINE gr.40

11451

dispenser 40 gr. glitter in 4 colori assortiti

05330

12 flaconi ml.25 colori assortiti
 (4 oro, 3 argento, 2 rosso,
 1 rosa, 1 blu, 1 verde)



Glitter a grana fine



GLITTER A GRANA FINE ml.150

05404

confezione 6 barattoli ml.150 - colori assortiti

da 130/100/1 a 130/100/11

barattolo glitter a grana fine ml.150 - unicolore

| | | |
|-------------------|--|-------------|
| 130/100/1 | | Oro |
| 130/100/2 | | Argento |
| 130/100/3 | | Rosso |
| 130/100/4 | | Blu |
| 130/100/5 | | Verde |
| 130/100/6 | | Fuxia |
| 130/100/7 | | Turchese |
| 130/100/8 | | Iride |
| 130/100/9 | | Rame |
| 130/100/10 | | Viola |
| 130/100/11 | | Verde acido |



PACK SCUOLA

GLITTER A GRANA FINE ml.700

da 05397 a 05403

barattolo glitter ml.700 - unicolore

| | | |
|--------------|--|----------|
| 05397 | | Oro |
| 05398 | | Argento |
| 05399 | | Rosso |
| 05400 | | Blu |
| 05401 | | Verde |
| 05402 | | Fuxia |
| 05403 | | Turchese |



GLITTER A GRANA FINE ml.150

06723

barattolo glitter ml.150
colore iride



PACK SCUOLA

GLITTER A GRANA FINE ml.1550 (1 kg.)

09776 a 09782

busta glitter ml.1550 - unicolore

| | | |
|--------------|--|----------|
| 09776 | | Oro |
| 09777 | | Argento |
| 09778 | | Blu |
| 09779 | | Verde |
| 09780 | | Rosso |
| 09781 | | Fuxia |
| 09782 | | Turchese |





Pasta neve

Materiale molto leggero a base acqua con cui è possibile ottenere un effetto "neve" o "pelliccia" su moltissime superfici: legno, polistirolo, pareti, carta, plastica, metallo, vetro... Asciuga rapidamente e può essere colorata in due modi: mescolandola con colori acrilici oppure dipingendola dopo averla fatta asciugare per circa 2 ore.



06104

flacone ml.250



Scaglie di ghiaccio

Scaglie cristalline che consentono di ottenere particolari EFFETTI GHIACCIO. Ideali per impreziosire con facilità ogni oggetto. Per ottenere bellissimi risultati basta applicare un po' di colla trasparente sulla superficie da decorare e versare sopra le scaglie.



06767

barattolo ml.150



Fiocchi di polistirolo

Neve in polistirolo per decorazioni.



10958

barattolo ml.350

Effetti "quarzo"

Minuscoli sassolini che consentono di decorare disegni, collage, diorama, forme in polistirolo e in plastica... Per incollare i quarzi, consigliamo di utilizzare una colla vinilica forte (es.: art. 05787 e 06103).

● da 05844 a 05854

(vedi cartella colori) barattolo ml.150 effetti "quarzo" - unicolore

| | | | | | |
|--------------|---|--------------|--------------|---|-------------|
| 05844 |  | Grigio | 05850 |  | Verde scuro |
| 05845 |  | Rosa | 05851 |  | Azzurro |
| 05846 |  | Giallo | 05852 |  | Blu |
| 05847 |  | Arancio | 05853 |  | Nero |
| 05849 |  | Verde chiaro | | | |













Effetti "scaglie"

Un'originale idea per personalizzare collage e disegni, ma anche per decorare forme in polistirolo, uova di plastica, ecc... L'effetto finale è simile al guscio rotto di un uovo!

● da 05831 a 05842

barattolo ml.150 effetti "scaglie" - unicolore

| | | | | | |
|--------------|---|--------------|--------------|--|---------------|
| 05831 |  | Verde scuro | 05837 |  | Rosa |
| 05832 |  | Verde chiaro | 05838 |  | Lilla |
| 05833 |  | Nero | 05839 |  | Rosso |
| 05835 |  | Blu | 05840 |  | Giallo chiaro |
| 05836 |  | Marrone | 05841 |  | Giallo |
| | | | 05842 |  | Bianco |



Plasto smalt

Granuli plastici che si sciolgono con il calore di un normale forno da cucina. Per ottenere originali gioielli, portachiavi, fermaposto basta versare i granuli in uno stampino in acciaio (art. 04267-04268-04269), metterli in forno e aspettare che si sciolgano.

● da 06561 a 07235

flacone ml.150 Plasto Smalt - unicolore



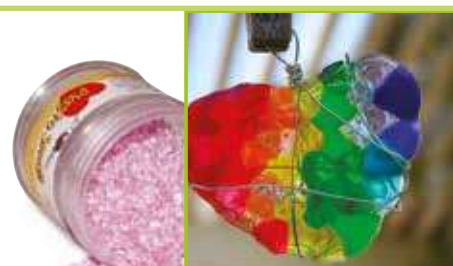









| | | |
|--------------|---|--------------------------|
| 06561 |  | Verde chiaro trasparente |
| 06562 |  | Verde scuro trasparente |
| 06564 |  | Arancio trasparente |
| 06565 |  | Fuxia trasparente |
| 06567 |  | Rosa trasparente |
| 06570 |  | Grigio coprente |
| 06571 |  | Nero coprente |
| 07232 |  | Madreperla coprente |
| 07233 |  | Ambra indiana coprente |
| 07234 |  | Giallo oro coprente |
| 07235 |  | Canna di fucile coprente |



Effetti "sabbia"

da 05819 a 05830

barattolo ml.150 effetti "sabbia" unicolore

| | | | | | |
|--------------|---|----------------|--------------|---|--------------|
| 05819 |  | Bianco | 05825 |  | Verde |
| 05820 |  | Rosa | 05826 |  | Rosso ossido |
| 05821 |  | Giallo chiaro | 05827 |  | Rosso |
| 05822 |  | Ocra | 05828 |  | Bruno |
| 05823 |  | Arancio | 05829 |  | Blu |
| 05824 |  | Verde smeraldo | 05830 |  | Nero |



03640

busta 8 tubetti sabbia colorata assortita

Specchietti decorativi

Molto indicati per impreziosire ogni oggetto o creare originali mosaici. Facili da ritagliare e incollare. Infrangibili, antisceggiata, realizzati in materiale plastico di sicurezza.



- 11331** - busta 4 stelle - cm.6
- 11332** - busta 4 stelle - cm.8
- 11333** - busta 4 stelle - cm.9,5

- 11334** - busta 4 cuori - cm.7
- 11335** - busta 4 cuori - cm.10

- 08672** - busta 30 cerchi - ø cm.1,5
- 08673** - busta 30 cerchi - ø cm.2,5
- 09412** - busta 6 cerchi - ø cm.8
- 09413** - busta 6 cerchi - ø cm.10

- 09400** - busta 30 quadrati - cm.1,5x1,5
- 08674** - busta 30 quadrati - cm.3,8x3,8



06652

busta 30 specchi assortiti in 3 forme
(tondo ø cm.1,5 - stella cm.2,5 - cuore cm.2,5)



08671

busta 52 specchi assortiti in 4 sagome
(tondo ø cm.1,5 - quadrato cm.1,5
stella cm.2,5 - cuore cm.2,5)



Specchi acrilici

In materiale plastico di sicurezza antiurto e antisceggiata, da personalizzare e rendere unici decorandoli con perline, microsfere, glitter, stencil, paste a rilievo, tessere mosaico, découpage... Da dipingere con colori per vetro, colori per ceramica, finto piombo.



05474x5

5 tondi ø cm.15



05475x5

5 quadrati cm.16x16



05476x5

5 ovali cm.14x20



05477x5

5 stelle cm.19x19



05478x5

5 fiori cm.19x19

Bastoncini in legno



05249

confezione 100 bastoncini in legno cm.25

Gancini appendiquadri in tessuto

Per appendere piccoli quadri, cornici, lavoretti, stampe eseguiti con polvere di ceramica o gesso ecc.



06497

100 gancini adesivi in tessuto ø cm.3

06549

12 gancini adesivi in tessuto ø cm.3

Fermacampioni



SCATOLA FERMACAMPIONI 100 PZ.

C440/16 - mm.16

C440/20 - mm.20

C440/25 - mm.25

C440/31 - mm.31

C440/40 - mm.40

C440/50 - mm.50

Carta paglia animata

Duttile e morbido, questo filo di ferro ricotto è rivestito con carta paglia.



1752 - 200 fili cm.65

1753 - 100 fili cm.130

Piedini portaritratto

In cartone preformato, facili da montare senza dover utilizzare colle o nastro adesivo. Indispensabili per mantenere in posizione verticale ritratti, lavoretti didattici, disegni. Ideale anche per vetrinistica.



07599x10

10 basi in cartone cm.14 h

Piedini portaritratto

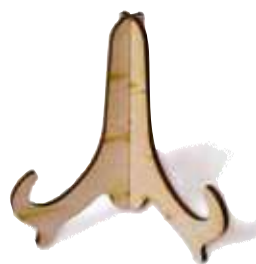

08082

portaritratti/piatti in legno cm.13

08083

portaritratti/piatti in legno cm.22



05415

cavalletto in legno cm.11x23 h

Filo per fiori



1760x50

50 fili plastificati per fiori
 ø mm.1x70 cm.

Filo animato



08198

filo animato argentato
 mt. 10x3 mm.

Filo animato



1743



1745

07122

07122

busta 50 fili guaina trasparente
 filo color argento
 ø mm.1,20x1 mt.

1743

filo animato rivestito in plastica
 bobina ø mm.1,3x100 mt.

1745

filo di ferro animato in plastica
 bobina ø mm.2x100 mt.

1747

filo animato rivestito in plastica
 bobina ø mm.4x100 mt.



Piattine animate

Fili di ferro ricotti e rivestiti in plastica. Molto duttili e resistenti, le piattine animate possono essere utilizzate per realizzare originali addobbi, lavoretti didattici, ecc...

Piattine costituite da filo metallico rivestito in plastica

1751

busta 150 piattine animate cm.20
 colori assortiti



Piattine costituite da filo metallico rivestito in plastica CONFEZIONE 1000 PIATTINE

1750/15 - cm.15

1750/20 - cm.20

Lacci in tessuto



11580

conf. 12 lacci colori assortiti (singolo laccio cm.60 x 2,5 mm. ø)

11581

conf. 24 lacci colori assortiti (singolo laccio cm.90 x 2,5 mm. ø)

Corde colorate



1715

busta 4 corde da mt.3 diametro mm.8
 (totale mt.12) colori assortiti

Filo sintetico

Ad altissima resistenza, rivestito in pvc colorato. Per confezioni, sigillature e legature, lavori didattici.



100
MT.

1755
PACK SCUOLA 10 rocchetti mt.100
peso gr.170 assortiti in 5 colori

Treccia in filato



96
MT.

07120
PACK SCUOLA
treccia in filato di polipropilene
mt.16x6 colori assortiti (totale mt.96)

Tubetti in PVC



96
MT.

07121
PACK SCUOLA
set tubetto in pvc ø mm.2
mt.12x8 assortiti (totale mt.96)

Fili morbidi in plastica (Scoubidou)

Realizzate ciondoli e pupazzetti che potrete fissare allo zainetto, al cellulare o alle chiavi di casa.



pag.526
manuale



07113
set "Scoubidou" in pvc, contiene: 18 mt. filo ø mm.2 in morbida plastica colori assortiti; 3 anelli portachia-
vi ø mm.20; 3 anelli portachia-
vi ø mm.30; 10 fili animati cm.10



07119
set "Scoubidou" in tessuto, contiene:
24 mt. treccia in tessuto polipropilene
colori assortiti; 3 anelli portachia-
vi ø mm.20; 3 anelli portachia-
vi ø mm.30; 10 fili animati cm.10



10443
set "Scoubidou" in pvc, contiene:
21 mt. filo assortito in 3 colori:
verde, bianco, rosso; 6 anelli
portachia-
vi; 10 fili animati



30
PEZZI

12653
portachia-
vi in metallo
ø mm.25 (30 pezzi)



Spago in fibra vegetale



FINE (2,6)

1039
gr.100 - mt.70 circa
BIANCO
Ideale per alimenti



FINE (2,6)

1032/3
gr.100 - mt.65 circa
1032/3/500
gr.500 - mt.260 circa



MEDIO-FINE (2,4)

1032/24
gr.100 - mt.35 circa



MEDIO (2,2)

1032/2
gr.100 - mt.25 circa
1032/2/500
gr.500 - mt.125 circa



GROSSO (2-3/4)

1032/1
gr.100 - mt.18 circa
1032/1/500
gr.500 - mt.90 circa



SPAGO COLORATO GR.25

11426 - rosso
11427 - giallo
11428 - verde
11429 - blu



Corda in canapa

Corda animata in canapa e juta con filo di ferro interno che la rende estremamente malleabile e facile da modellare.



1700
corda animata in canapa ø mm.6x2 mt

Gomitoli in juta

100% juta naturale per realizzare oggetti e accessori unici ed originali.

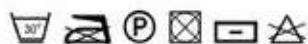

11397
5 gomitoli colori assortiti
100% juta naturale gr.100 - mt.65 (cad.)



Rafia naturale

pag.248
truciolo colorato

Con il suo aspetto grezzo e naturale si presta perfettamente alla realizzazione di biglietti augurali, pacchi regalo, lavoretti didattici e molti altri oggetti. I nuovi colori consentono di realizzare confezioni e lavori di grande effetto.

RAFIA COLORI ASSORTITI

04775

confezione 10 pacchetti rafia gr.50

RAFIA pacchetto gr.50 UNICOLORE (minimo 6 pezzi)
OGNI PACCHETTO SONO CIRCA 30 FILI DI
LUNGHEZZA MT.1,50/CAD.

| | | |
|-------|---|-----------------|
| 1731 |  | Naturale |
| 04658 |  | Lavanda |
| 04659 |  | Blu pastello |
| 04660 |  | Blu roi |
| 04661 |  | Rosa fuxia |
| 04662 |  | Rosso cardinale |
| 04663 |  | Verde salvia |
| 04664 |  | Verde Natale |
| 04665 |  | Giallo |
| 04666 |  | Arancio |
| 04667 |  | Rosa |
| 08528 |  | Bordeaux |
| 08529 |  | Verde acido |
| 08530 |  | Viola |
| 08531 |  | Marrone |
| 08532 |  | Nero |



Rafia sintetica

RAFIA sintetica bobina mt.170 gr.90 - COLORI ASSORTITI

1730/ASS - confezione 10 bobine

RAFIA sintetica bobina mt.170 gr.90 - UNICOLORE
minimo acquistabile 5 pezzi

| | | |
|---------|---|---------|
| 1730/01 |  | Rosso |
| 1730/02 |  | Bianco |
| 1730/03 |  | Azzurro |
| 1730/04 |  | Giallo |
| 1730/05 |  | Nero |
| 1730/06 |  | Arancio |
| 1730/07 |  | Verde |
| 1730/08 |  | Marrone |
| 1730/09 |  | Rosa |
| 1730/10 |  | Viola |
| 1730/11 |  | Blu |



Sbalzo



Lo sbalzo é un tipo di incisione ad alto e bassorilievo di lastre in rame. Gli oggetti che si possono ottenere sono innumerevoli: quadretti, targhe, scatoline portaoggetti, bigiotteria e tutto ciò che la fantasia e l'ingegno, stimolati dalla plasticità e dalla consistenza delle lamine, suggeriscono.

CONFEZIONE 12 LASTRINE ALLUMINIO ANODIZZATO RAME - SPESSORE 0,12 MM.

113/1 - cm.10x15

113/2 - cm.15x20

113/3 - cm.15x30

113/4 - cm.20x30

113/5 - cm.30x30

113/7 - cm.30x40

MODALITA' D'USO



Prendete una scatola tonda in legno (art. 05960); posizionate il coperchio della scatola sul foglio di rame e, con il bulino n°10, tracciatene la circonferenza. Ritagliate poi la sagoma con un paio di forbici. Appoggiate un feltro sul piano di lavoro. Sistemate un disegno sul retro della lamina (il lato

argentato) e ricalcate il motivo con un bulino, cercando di esercitare una pressione costante. Ripassate il disegno con un bulino a punta larga. Lavorate poi il decoro con i vari bulini così da rendere movimentato il disegno: ad ogni attrezzo corrisponde un diverso tratto.

Bulini per sbalzo

Indispensabili strumenti per ottenere molteplici effetti di alto e bassorilievo. Indicati per attività di sbalzo su rame ed embossing. Punta in acciaio.



da 111/01 a 111/12

bulino per sbalzo cm.18,5 in blister singolo

111/1

confezione 10 bulini cm.18,5 modelli assortiti confezionati singolarmente in blister

da 03643 a 03645

bulino per sbalzo/embossing con doppia punta cm.18,5



115 - set per sbalzo
contiene: 4 ferri per sbalzo,
12 lastre alluminio anodizzato
cm.10x15, 1 feltro cm.10x15,
1 foglio di istruzioni



09869 - set per sbalzo

contiene: 1 piano di lavoro con feltro, 2 bulini per sbalzo,
album 12 lastre alluminio anodizzato rame cm.10x15

Feltro ad alta densità

1582/1x5

5 feltri - cm.10x15

1582/2x5

5 feltri - cm.15x20

1582/3x5

5 feltri - cm.20x30

FELTRO ALTO SPESSORE

10634

5 feltri - cm.16x20x1

10635

1 feltro - cm.24x33x1

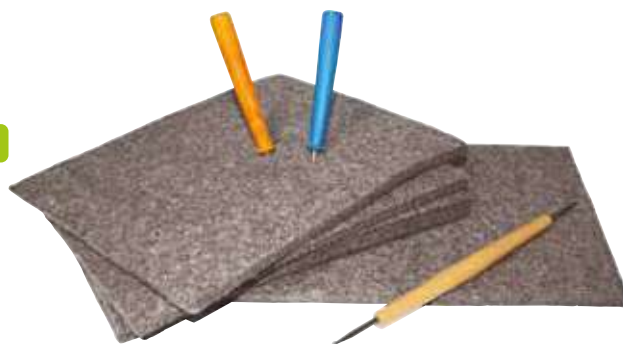

Linoleografia



114

valigetta, contiene: 5 scavini,
1 tubo inchiostro ml.22, rullo
cm.6, 1 tavoletta linoleum
cm.9x12

L'incisione su linoleum è una delle forme più semplici di stampa che vi permetterà di realizzare biglietti augurali, scatole, quadri e tanti altri oggetti.



INCHIOSTRO PER LINOLEOGRAFIA ML.20

da 12457/1 a 12457/6

- 12457/1 bianco
- 12457/2 nero
- 12457/3 blu
- 12457/4 verde
- 12457/5 rosso
- 12457/6 giallo

Pannello poli-vinyl



- 12370 - pannello cm.18x24
- 12371 - pannello cm.24x30
- 12372 - pannello cm.30x40

base per linoleografia, grafica, pittura e disegno



Tavolette linoleum



- 119x6 - 6 lastrine cm.9x12
- 120x6 - 6 lastrine cm.12,5x18
- 121x6 - 6 lastrine cm.15x25
- 122 - cm.25x25
- 09674 - cm.33x33
- 09675 - cm.33x40

Piano di lavoro in legno



10639

tavoletta in legno dotata di fermi per avere un piano di lavoro stabile e sicuro. Area di lavoro cm.22x31



Rulli linoleografia

RULLO in gomma con manico in metallo

- 117/6 - rullo \varnothing cm.2,2x6
- 117/10 - rullo \varnothing cm.2,2x10

Scavini/sgorbie

Indicati per la lavorazione di legno e linoleum, gli scavini consentono di ottenere effetti particolari in modo facile e veloce.



04616

manico portapennini completo di 5 pennini per incisione



05652 - blister 6 scavini assortiti cm.13,5

04552 - conf. 12 scavini assortiti cm.13,5

125 - conf. 6 scavini assortiti professionali manico in legno, lama in acciaio temperato
dimensioni: cm.13,5



Metalgraf - Scratch-Art

Il Metalgraf è chiamato anche "Scratch-Art", ossia l'effetto che si ottiene graffiando una superficie. La superficie di Metalgraf è costituita da uno strato sottostante in metallo ricoperto da uno strato nero. Graffiando la superficie nera con l'ausilio di un punteruolo si otterrà un effetto molto piacevole risultante dalla contrapposizione del metallo con il nero opaco.



graffia e scopri
l'effetto metallizzato!

● **730x5**

5 cartoncini Metalgraf gr.200 - cm.25x35



1583

12 punteruoli con impugnatura cm.9

06219

punteruolo con manico in abs punta \varnothing mm.1
in acciaio temperato lunghezza cm.14,5
(non adatto a bambini)



1585

piano di lavoro con punteruolo
dimensioni: cm.16x23



09886

ceppo portapunteruoli (in legno)
base cm.21x10x2,4 h - 18 posti

Calcografia

Le principali tecniche di stampa calcografica sono la puntasecca e l'acquaforte.

PUNTA SECCA

Consiste nell'incidere su una lastra di rame o zinco con uno strumento chiamato "punta". Una volta incisa, la lastra viene inchiostrata e poi ripulita affinché l'inchiostro rimanga solo nelle parti precedentemente incise, dopodiché viene collocata sul torchio calcografico per la stampa.

ACQUAFORTE

La lastra di zinco viene ricoperta da un sottile strato di cera d'api, oppure bitume o vernice satinata. Successivamente, con un qualsiasi strumento a punta, si asporta il materiale protettivo affinché restino scoperte le parti che poi verranno stampate; dopo di che, affinché non venga corrosa, si isola il retro della lastra con comune nastro adesivo e la si immerge in acquaforte (miscela formata da tre parti d'acqua e una di acido nitrico). L'acquaforte corrode le parti della lastra rimaste senza protezione. La lastra deve rimanere in acido per un tempo proporzionato al tipo di segno desiderato. Tolta la lastra dall'acido, bisogna asciugarla ed eliminare il nastro adesivo e la cera, dopodiché viene inchiostrata, ripulita e messa al torchio.



Torchio manuale

Torchio per la stampa calcografica manuale, adatto soprattutto per uso scolastico e per principianti. Rulli in acciaio massiccio regolabili in altezza. Fornito con lastra in metallo.

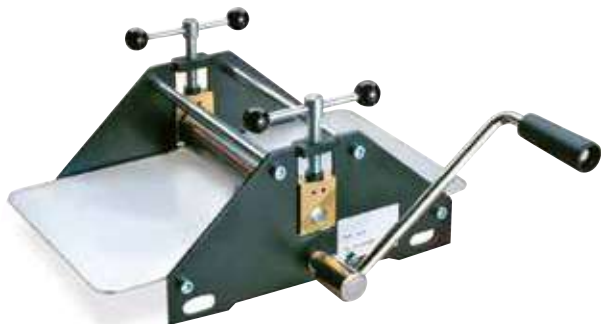

08068 - torchio in metallo

Piastra riscaldante

Piastra riscaldante in acciaio verniciato e piano in alluminio anodizzato di grosso spessore per evitare deformazioni dovute al riscaldamento e garantire la distribuzione uniforme del calore.



08536 - piastra riscaldante

CARTONCINO

10679

rosaspina: cartoncino bianco filigranato a macchina in tondo, 60% cotone, cm.50x70, gr.220



FELTRI PER TORCHIO

08069

feltro per torchio (art.08068) cm.26,8x42x0,3

10892

cm.51,8x100x0,3



LASTRE DI ZINCO spessore mm.1

08537 - cm.6x9

08538 - cm.9x12

08539 - cm.10x15

08540 - cm.18x24

08541 - cm.24x30

08542 - cm.30x40

LASTRA SINTETICA

08535

lastra sintetica per torchio (art. 08533) cm.51,8x100x1







Inchiostri calcografici

A base di sego ed olio di lino polimerizzato, miscelati con pigmenti stabili e non nocivi per la salute. Si possono utilizzare puri o diluiti con trementina, diluente inodore o essenza di petrolio.



INCHIOSTRO ML.60

da 10700 a 10704

- 10700**  Sanguigna
- 10701**  Nero caldo
- 10702**  Nero freddo
- 10703**  Seppia
- 10704**  Bianco

INCHIOSTRO ML.60

da 10705 a 10707

- 10705**  Giallo limone
- 10706**  Carminio
- 10707**  Cyan



Puntasecca

Punte professionali utilizzate per l'incisione delle lastre in zinco nella tecnica della puntasecca e anche in altre tecniche calcografiche. Grazie all'estrema precisione che consentono di ottenere, le punte trovano ampio utilizzo anche per l'incisione a sbalzo, per la ceramica e la scultura in genere.

08563

punta \varnothing mm.1 in acciaio temperato manico in legno



08564

punta \varnothing mm.1,5 in acciaio temperato manico in legno



08565

punta \varnothing mm.2 in acciaio temperato manico in legno



06219

punta \varnothing mm.1 in acciaio temperato, manico in abs lunghezza cm.14,5



04334

punta \varnothing mm.1,5 in acciaio temperato manico in metallo lunghezza cm.12,5



04335

punta \varnothing mm.3 in acciaio temperato manico in metallo lunghezza cm.12,5



PIETRA IN CARBURO DI SILICIO

10655

pietra a impasto fine per affilare le punte di vari strumenti



SPATOLA IN GOMMA FLESSIBILE

10678

spatola in gomma flessibile cm.8x11



Maschere in acciaio per embossing

Per realizzare eleganti decorazioni e bordi su carte da lettere, biglietti augurali, menù, ecc. ecc. E' sufficiente posizionare una mascherina sul tavolo luminoso, sovrapporre il foglio da decorare e calcare sui contorni utilizzando uno degli appositi bulini.

da 04234 a 04238

maschere cm.3x18



04234 - uva



04236 - cuori

da 04395 a 04402

maschere cm.5,5x8



04235 - orsetti



04238 - agrifoglio



04395
lettere
maiuscole



04396
lettere
minuscole



04397
palme



04398
tulipani



04399
rose



04400
Pasqua



04401
Natale



04402
edera+stella
di Natale

BULINI PER EMBOSSING

da 03643 a 03645

bulini per embossing cm.18,5
Due punte per un duplice utilizzo.



Polveri per embossing

POLVERE DI VELLUTO

Stendere la colla sul disegno a rilievo, cospargere la superficie con la polvere di velluto ed eliminare il materiale in eccesso. Il disegno acquisterà un aspetto vellutato alla vista e morbido al tatto.

03861/1 a 03861/6

flacone ml.35 polvere di velluto



03861/1 giallo 03861/2 arancio 03861/4 verde 03861/5 blu 03861/6 terra

POLVERE MINERALE

Incollata sulla decorazione a rilievo le conferisce una delicata colorazione.

da 03871/1 a 03871/6

flacone ml.35 polvere per embossing

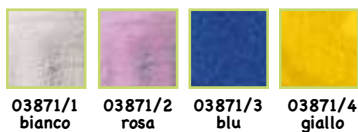

03871/1 bianco 03871/2 rosa 03871/3 blu 03871/4 giallo



03871/5 verde 03871/6 rosso

POLVERI A FUSIONE

Le polveri metallizzate sono coprenti, quelle trasparenti fanno risaltare il colore dell'inchiostro utilizzato per fare il timbro. Le polveri olografica e perlata non coprono il colore dell'inchiostro, ma gli conferiscono un aspetto rispettivamente glitterato e perlato.



da 05456 a 05461

flacone ml.25 polvere per embossing



05456 trasparente 05458 argento 05459 rame 05460 olografico 05461 perlato

Asciugatore

Per l'embossing e per molti altri lavori creativi: riscalda senza emettere getti d'aria.



05449

asciugatore phon (heat gun) con interruttore. **Riscalda senza emettere getti d'aria** (che disperderebbero la polvere). Conforme alle norme CE sulla sicurezza. Dati tecnici: 230V - 50 Hz, 300W

Soft velvet

03583

valigetta Soft Velvet, contiene: 3 flaconi ml.35, polvere di velluto colori assortiti, 2 stencil, 1 colla stick, 1 colla liquida, 2 flaconi glitter, 1 pennello



Tavoli luminosi

L'embossing tradizionale consiste nel realizzare decorazioni a rilievo tramite l'uso di stencil in acciaio, bulini e tavolo luminoso. L'embossing con timbri, invece, prevede l'uso di particolari polveri che - scaldate con l'apposito asciugatore - assumono un aspetto "a rilievo". Pratici ed economici, questi tavoli luminosi sono molto indicati per lavori di embossing ma anche per visualizzare diapositive, lucidi, pellicole, ecc...



10826

tavolo luminoso cm.27x41 (piano di lavoro cm.23x32)
completo di impianto elettrico, illuminazione a led

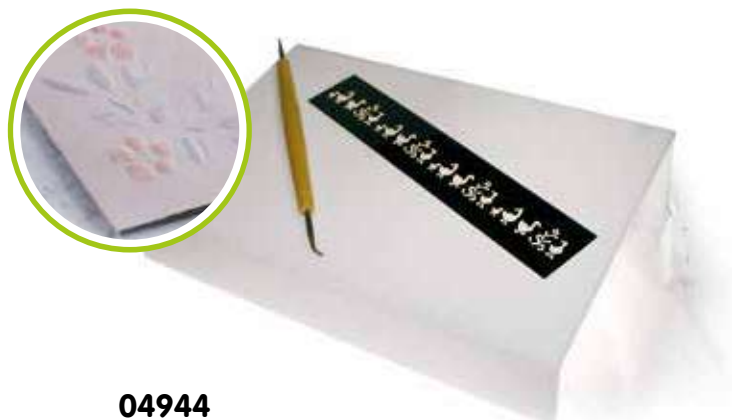

04944

tavolo luminoso cm.23x15 completo di impianto elettrico:
cavo e spina



10825

tavolo luminoso cm.64x45 (piano di lavoro cm.59x39)
completo di di impianto elettrico, illuminazione a led



03816

tavolo luminoso cm.25x40 completo di lastra opaline
cm.23x32 completo di torcia al neon (pile escluse)

Piano luminoso cambiacolor

Il piano luminoso cambiacolor (12 luci LED regolabili con l'apposito telecomando) è una lavagna bianca, opaca, che ha una base in legno con bordi arrotondati per la massima sicurezza. Robusto, trasportabile e facilmente lavabile, il PIANO LUMINOSO può essere retro-illuminato collegandolo a una normale presa elettrica attraverso un cavo con trasformatore a basso voltaggio in dotazione (in conformità con le normative europee sulla sicurezza) consentendo di sperimentare effetti di luci e colori grazie all'ausilio di fogli di acetato e palette cromatiche.

12555

piano luminoso cm.62x42x7 (in legno)
Completo di lavagna bianca opaca e luce LED multicolore ad alta intensità diffusa che permette di selezionare oltre alla luce bianca quella colorata in modo da regalare un nuovo scenario cromatico alle attività svolte con il piano luminoso.



Frammenti di doratura

Utilizzando la giusta colla (art. K66), i frammenti aderiscono ad ogni superficie: dal legno, al sughero, dalla plastica al vetro.

FRAMMENTI DI DORATURA GR.3,5

- da 06755 a 06757
- da 06758 a 06778

| | | |
|--------------|---|-----------------|
| 06755 |  | Oro |
| 06756 |  | Rame |
| 06757 |  | Oro/Rame |
| 06758 |  | Variegato rosso |
| 06778 |  | Variegato verde |





Fogli metallizzati

Da applicare delicatamente con l'aiuto di un pennello sulle superfici da decorare, già trattate con colla missione.



CONFEZIONE 25 FOGLI CM.14X14

da 04405 a 04407

| | | |
|--------------|--|---------|
| 04405 |  | Oro |
| 04406 |  | Rame |
| 04407 |  | Argento |

CONFEZIONE 10 FOGLI ACIDATI CM.14X14

da 06752 a 06753

| | | |
|--------------|---|----------------|
| 06752 |  | Variegato oro |
| 06753 |  | Variegato Rame |



Doratura a polvere

POLVERE PER DORATURA - FLACONE 35 ML.

| | | |
|--------------|---|------|
| 06105 |  | Oro |
| 06106 |  | Rame |

PASTA PER DORATURA - FLACONE 35 ML.

| | | |
|--------------|---|---------|
| 06107 |  | Argento |
|--------------|---|---------|



Super Adesivo Tekel

Tekel, una volta steso sulla superficie, crea una sorta di pellicola che si mantiene adesiva per molto tempo, permettendo così di effettuare i lavori di doratura (sia con fogli che con polveri) subito oppure a distanza di parecchie ore dalla stesura dell'adesivo.

06345

barattolo ml.150



Carta per découpage e scrapbooking pag.22

carte decorative



- **04849** - 15 fogli cm.25x35 - soggetti assortiti
- **09916** - 10 fogli carta cm.50x70 - soggetti assortiti
- da 04851 a 07200** - confezione 10 fogli carta cm.50x70 - monosoggetto



04851
lamponi



04862
girasoli



● 04864
dolcetti



04866
orsetti



04867
abc



04869
patchwork



● 05705
edera



05722
melograni



06861
putti su albero



06863
verdure



06865
angeli+fiori



● 07200
Natale

da 11524/1 a 11524/6

foglio carta cm.35x50 monosoggetto natalizio



● 11524/1
soggetti natalizi 1



● 11524/2
soggetti natalizi 2



● 11524/3
soggetti natalizi 3

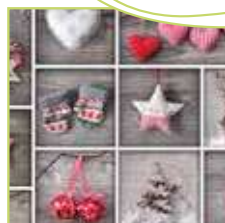

● 11524/4
soggetti natalizi 4



● 11524/5
soggetti natalizi 5



11524/6
soggetti natalizi 6

Carte indicate per lavori di scrapbooking!
Utilizza anche le fustelle per impreziosire il tuo lavoro!

da 06890 a 06895

confezione 2 fogli carta cm.29,7x42 - due soggetti



● 06890 - modello A



06893 - modello D



● 06894 - modello E



06895 - modello F

06889

confezione 12 fogli carta cm.29,7x42 - soggetti assortiti

Découpage 3D piatto

Una tecnica semplice, ma di grande effetto, molto utilizzata per la realizzazione di biglietti augurali, scatole e quadretti.

I set 3D contengono 4 stampe identiche dello stesso soggetto e le istruzioni per ottenere l'effetto tridimensionale sovrappo-ponendo i dettagli delle stampe con il supporto del biadesivo. Gli articoli 05557, 05563, 05567 danno modo di realizzare più di un lavoro, in quanto sulla stessa stampa sono raffigurati vari soggetti.

da 05557 a 05569

set 4 fogli cm.9x12

05562 - set 4 fogli cm.17x22

05563 - set 4 fogli cm.10x15

05567 - set 4 fogli cm.10x15

05571 - set 4 fogli cm.15x21

05573 - set 4 fogli cm.13x18



05557
2 orsi Natale



05558
clown



05559
orsetta



05560
giardino



05561
vaso fiori



05569
fragole



05562
fiori + tazze



05563
animali



05567
vasi fiori



05571
orsetti dal fioraio



05573
inverno

da 06242x3 a 06247x3

3 buste da 1 foglio con 4 stampe (soggetto cm.10,5x13,5 h)



06242x3
cesto fiori



06248x3
bimba con gatto



06244x3
gatto



06245x3
cane



06246x3
candela natalizia



06247x3
orsetto con fiori

Tovaglioli per découpage



Valigetta découpage
con tovaglioli

BUSTA 6 TOVAGLIOLI CM.33x33 - ASSORTITI

06811 - soggetti pasquali

06812 - soggetti natalizi

06813 - soggetti generici

04772

la valigetta contiene: 1 paio di forbici, 1 spugna, 1 cutter, 1 pennellina, 1 pennello, 1 colla trasparente, 1 vernice trasparente a base acqua, 1 dettagliato libretto informativo e un assortimento di tovaglioli di carta

Tovaglioli di carta

Al fine di soddisfare la continua richiesta di aggiornamenti, i disegni riportati sono soggetti a variazioni senza preavviso.

04812 - confezione 20 tovaglioli cm.33x33 - soggetti assortiti
da 210051 a 611829 - pacchetto 20 tovaglioli cm.33x33 - monosoggetto



210250
edera



210405
paperotti



210409
narcisi



210545
comunione



210051
girasole



210221
conigli



211235
Uova di Pasqua



211435
rose



211828
cactus



211837
farfalle



210608
galli e pulcini



210709
conigli in gita



610125
stella di Natale



610417
ghirlanda Natale



610534
peluches Natale



610618
soggetti natalizi



610112
Babbo Natale



610117
presepe



611829
pupazzi di neve

OFFERTA SPECIALE PER ESAURIMENTO

da 06617 a 210770

pacchetto 20 tovaglioli cm.33x33
monosoggetto



06617
anguria/melone



06624
paesaggio toscano



06876
caffè



06877
natura morta



06878
animali su barca



07662
pappagalli



07663
geco/farfalla



07664
gabbiani



210322
crostacei



210330
fragola selvatica



210331
uva



210445
limoni



210462
cane



210748
ribes



210770
faro/gabbiano

Pennellesse

Pennelli con manico in legno particolarmente indicati per distribuire in modo preciso la colla e le vernici di finitura, senza lasciare striature o accumuli.



K555/25x12

12 pennellesse - larghezza mm.25

K555/38x12

12 pennellesse - larghezza mm.38

K555/50x12

12 pennellesse - larghezza mm.50

K555/63x12

12 pennellesse - larghezza mm.63

Vernice

La vernice trasparente deve essere distribuita in modo uniforme su tutta la superficie; ha la funzione di proteggere la decorazione dall'acqua e dalla polvere. A seconda della vernice utilizzata è possibile ottenere diversi effetti: un effetto laccato e lucido, oppure un effetto opaco e satinato.



BARATTOLO ML.150

04815 - all'acqua "effetto lucido"

04816 - all'acqua "effetto opaco"

Colle

Colle specifiche a seconda del materiale utilizzato per decorare la superficie. Se la decorazione viene realizzata con ritagli di carta, fotografie, cartoline consigliamo di usare la colla forte per découpage, trasparente e atossica. Se invece vengono utilizzati tovaglioli di carta è indicata la colla delicata, anch'essa trasparente e atossica.



BARATTOLO ML.250

04820 - colla delicata

04821 - colla forte

Aggrappante Primer

Vernice inodore, priva di solventi, ideale per preparare fondi su superfici difficili come vetro, plastica, metallo... Indicata per tecniche che necessitano di una superficie liscia su cui lavorare. Facilita la stesura di qualsiasi tipo di colore.



06454

flacone ml.150

Verni Acqua

Vernice trasparente di finitura a base acqua. Garantisce un effetto trasparente semi-lucido, proteggendo la decorazione dalla polvere e dall'acqua. Facilmente pennellabile e di buona copertura.



07007

flacone Verni Acqua
ml.500

Colla spray

Assicura una distribuzione rapida e omogenea sulle superfici. Molto indicata per la tecnica del découpage con tovaglioli: spruzzata sul tovagliolo, infatti, questa colla lo rende più resistente e facile da ritagliare.



07147

colla spray per découpage ml. 400

Forbicine



04880

forbici punta curva - cm.9

05496

forbici punta dritta - cm.9

Spugnette biadesive

Ideali per dare spessore alle realizzazioni con *découpage* 3D ma anche per incollare con facilità svariati oggetti. I tondini sono già pronti per essere applicati.



mm.6x1 h

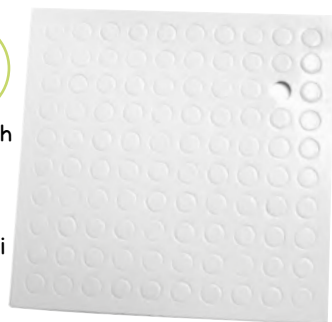

● 09758

200 tondini biadesivi pretagliati

1584

pinzetta in metallo
Ideale per posizionare con cura i ritagli più piccoli.



Piano di lavoro

05611

piano di lavoro con base in feltro + bulino
base cm.16x23 h

Scatole in metallo

Scatole in metallo con coperchio. Potrete dipingerle con colori acrilici e successivamente applicare le figure ritagliate da carta o da tovaglioli, realizzando originali barattoli personalizzati, ideali anche da regalare.

● **04884** - scatola cilindrica piccola \varnothing cm.11x8,5 h

04885 - scatola cilindrica grande \varnothing cm.11x16 h

04886 - scatola rettangolare cm.16x22x7,5 h



Scatole decubox

Queste scatole di cartone pesante costituiscono un supporto ideale per i lavori di *découpage*. Le scatole, disponibili in due differenti formati, non sono assemblate.



04910x5 - 5 scatole cm.14x16x8 h

04911x5 - 5 scatole cm.16x21x11 h



07123 - cm.35x25x17 h con coperchio

Balsa e legni vari

Legni di balsa, ramino e betulla antisceggia, di qualità, resistenti e flessibili. Adatti per modellismo, bricolage, fai-da-te...

TAVOLETTE IN BALSA cm.10x100

- 0601/1x10** - 10 tavolette - spessore mm.1
- 0601/2x10** - 10 tavolette - spessore mm.2
- 0601/4x4** - 4 tavolette - spessore mm.4
- 0601/6x4** - 4 tavolette - spessore mm.6

LISTELLI IN BALSA cm.100

- 0610/1x20** - 20 listelli - sezione mm.3x3
- 0610/2x20** - 20 listelli - sezione mm.3x10
- 0610/3x20** - 20 listelli - sezione mm.5x5
- 0610/4x20** - 20 listelli - sezione mm.5x10

BLOCCHI IN BALSA

- 0605/2** - cm.35 - sezione mm.50x50
- 0605/3** - cm.40 - sezione mm.100x100

TONDINI IN RAMINO cm.100

- 0635/2x12** - 12 tondini - spessore mm.2
- 0635/4x6** - 6 tondini - spessore mm.4
- 0635/6x6** - 6 tondini - spessore mm.6

COMPENSATO DI BETULLA

- 0634/04** - cm.30x60 - spessore mm.1
- 0634/2** - cm.20x60 - spessore mm.2
- 0634/4** - cm.20x60 - spessore mm.4



TAVOLETTA IN LEGNO DI BETULLA

SPESSORE
MM.18

- 07997**
tavolettina cm.10x35x18 mm. spessore
- 07998**
tavolettina cm.15x24x18 mm. spessore
- 07999**
tavolettina cm.20x29x18 mm. spessore



COMPENSATO DI PIOPPO

SPESSORE
MM.4

- 1312/1**
compensato cm.20x30x4 mm. spessore
- 1312**
compensato cm.30x40x4 mm. spessore

Country painting

Sagome in legno da decorare a piacimento con colori acrilici e con tanti altri materiali. In ogni kit troverete una sagoma in legno di betulla, il cartamodello con spiegazioni e suggerimenti sui colori da usare, foto a colori dell'oggetto da realizzare.



soggetto dipinto
in stile country

08235

1 sagoma in legno cm.6x15 h
soggetto: coniglio

08236

1 sagoma in legno cm.7,5x9,5 h
soggetto: gallina (frontale)

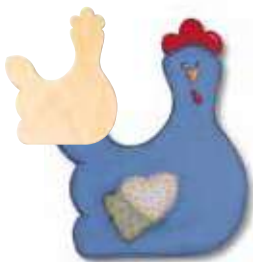

08236



08237



08238

08237

1 sagoma in legno cm.8,5x9,5 h
soggetto: gallina (profilo)

08238

1 sagoma in legno cm.12x15 h
soggetto: Babbo Natale

08239

1 sagoma in legno cm.11x9 h
soggetto: pecora



08239



08240



08241

08240

1 sagoma in legno cm.10,5x20,5 h
soggetto: bambina

08241

1 sagoma in legno cm.11x10 h
soggetto: zucca

08242

1 sagoma in legno cm.10x10 h
soggetto: papera

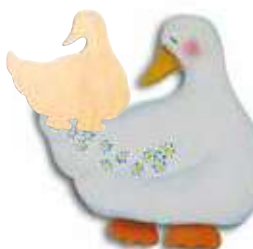

08242



08243



08244

08243

1 sagoma in legno cm.13x10 h
soggetto: mucca

08244

1 sagoma in legno cm.10x15 h
soggetto: pupazzo di neve

08245

1 sagoma in legno cm.9,5x9,5 h
soggetto: orsetto (frontale)



08245



08246



08247

08246

1 sagoma in legno cm.8,5x10,5 h
soggetto: orsetto (profilo)

08247

1 sagoma in legno cm.16,5x20 h
soggetto: stregghetta

Trafofo



1611
scatola traforo 5 pezzi
cm.23x35x3 h



1600
blister traforo cm.25x35
(4 pezzi)



1601
set completo traforo
cm.34x49



09839
set completo traforo
con accessori

Termotraforo per espanso



1500
termotraforo elettrico
dimensioni piano cm.24x32x5 h
lunghezza cm.44 - 220V

1506x6

6 fili di ricambio per termotraforo
(art. 1500, TH/007)

Archetto a batterie per espanso



TH/007

archetto a batterie (escluse)
dimensioni: cm.11x26x2 h
profondità taglio cm.22

Archetto per traforo



1598
archetto per traforo cm.13x30

ASTUCCIO 144 LAME PER TRAFORO

1599/1 - n° 1

1599/2 - n° 2

1599/3 - n° 3

1599/4 - n° 4

1599/5 - n° 5

1599/6 - n° 6

Accessori



1315
confezione 48 modelli in carta da
incollare su compensato per realizzare
oggetti con il traforo - cm.30x40



CONFEZIONE 6 TAVOLE IN COMPENSATO

04612 - cm.30x40
spessore mm.4 - soggetti: edifici assortiti

04613 - cm.30x40
spessore mm.4 - soggetti: aerei assortiti

Espanso

Materiale leggero, si taglia con forbici,
cutter, termotraforo.



| cm. 0,4

● 1314x10

10 lastre di espanso pressato densità 30
cm.30x40x0,4 h

Banco falegname

Banchi da lavoro per professionisti, amanti del fai da te, bambini, scuole... Una lunga tradizione ed esperienza garantiscono la qualità eccellente di questo prodotto.



09721

banco falegname (in legno)
dimensione: cm.83x36x53 h
larghezza banco: cm.70,5
peso totale: kg.13

Accessori per traforo



1595
tenaglia cm.4x14



1593



1596

1593
trapanetto cm.25

1596
martello cm.20



1594



1597

1594x6

6 basette cm.6x16,5

1597

morsetto cm.5 x12

Scavini/sgorbie

Pratici e resistenti accessori indispensabili per artisti e scultori. Particolarmente indicati per la lavorazione di legno e linoleum, gli scavini consentono di ottenere effetti particolari in modo facile e veloce.



05652
blister 6 scavini assortiti
cm.13,5

04552
conf. 12 scavini assortiti
cm.13,5



125
confezione 6 scavini
assortiti professionali,
manico in legno, lama
in acciaio temperato
cm.13,5



04551
conf. 6 scavini
con impugnatura
anatomica cm.13



04616
manico portapennini
completo di 5 pennini
per incisione



Cera pronta



04287

busta gr.500 "lenticchie"
di cera bianca premiscelata
(paraffina + stearina)

04431

barattolo ml.350
"lenticchie" di paraffina

04432

barattolo ml.350 "lenticchie"
di stearina (presenta un
colore bianco opaco)

04288

barattolo ml.350 cera GEL



Fornello

00510

fornello 230V - 50HZ - 650W
dimensioni: ø piastra cm.19



Portacero



04446

portacero in metallo
ø cm.8,5x10 h

04444

portacero piccolo in metallo
ø cm.8,5x4,5 h

04445

portacero grande in metallo
ø cm.13x6 h

Stoppini per candele



Trecciolino in cotone tipo extra
per moccioni, candele gel ecc...

BOBINE DA 20 METRI

04294

per candele ø da cm.5 a 7

04295

per candele ø da cm.7 a 9

Stoppino tondo per candele

BOBINE DA 30 METRI

04291

per candele ø da cm.1 a 2

04292

per candele ø da cm.2 a 3,5

04293

per candele ø da cm.3,5 a 5,5

04429

per candele ø da cm.2 a 4 - mt.2

04430

per candele ø da cm.5 a 9 - mt.1



04339

busta 24 stoppini cerati
con base in metallo - cm.10 h

04340

busta 24 stoppini cerati
con base in metallo - cm.3,5 h

Base portastampi

Questo strumento consente di realizzare decorazioni oblique o circolari sulle candele. Basta fissare lo stampo alla base portacandele, versare la cera calda e inclinare lo stampo (per ottenere decorazioni oblique) o ruotarlo su se stesso (per decorazioni circolari).



● **04591**

base portastampi cm.28x6 h



CONFEZIONE 10 FOGLI PLASTICA
TRASPARENTE PER AVVOLGERE

04948 - cm.30x30

04949 - cm.50x50

Stampi

Prodotti in policarbonato, un materiale molto resistente agli urti e al calore. Tutti gli stampi per candele sono riutilizzabili.



04271
cilindro ø cm.5x10 h



04272
cilindro grande
ø cm.5x14 h



● **04275**
cono cm.5,5x14 h



● **04276**
sfera ø cm.6,5



● **04273**
cilindro ø cm.4,4x6,5 h



04274
piramide cm.6x22 h



● **04277**
uovo cm.4,5x6,5 h



04278
sfera ø cm.7

Stampi per colata

Ideali per tutti i materiali a colata: sapone, ceramica, cera, gesso, ecc...



04928
orsetto + ippopotamo



04929
cuore + conchiglia



04933
cuori



04572



04571

← cm.10

OFFERTA SPECIALE PER ESAURIMENTO



04930
ovale con gatto + elefante

04931
ottagono + stella

05636
orologio + rettangolo

04571
stampo cm.21x23 - sole (2 pz)

● **04572**
stampo cm.21x23 - stella + fiore

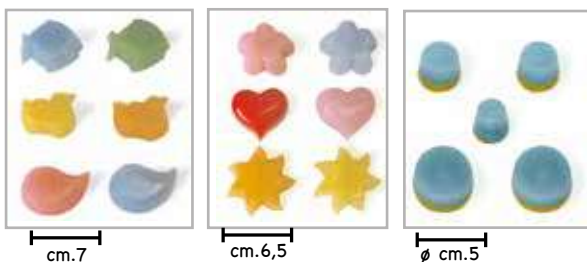

Dimensioni stampi: cm.21x23

OFFERTA SPECIALE PER ESAURIMENTO

- **04436** - 6 soggetti: pesce, papera, goccia
- **04438** - 6 soggetti: fiore, cuore, sole
- **04439** - 5 soggetti: cilindri di varie dimensioni



Dimensioni stampi: cm.15x21

OFFERTA SPECIALE PER ESAURIMENTO

- **05302** - stampi "animali"
- **04934** - stampi "frutta"



04935 - stampo: rosa

04936 - stampo: sole

04937 - stampo: cavallino

Pirografi

Il pirografo è l'attrezzo elettrico attraverso il quale è possibile incidere su legno e cuoio: è composto da una "penna" la cui punta, scaldandosi, consente di incidere decorazioni o disegni su legno, cuoio, pelle...



08724
pirografo completo di
20 accessori
potenza: 30W - 230V

ANSE DI RICAMBIO PER PIROGRAFI

07493
ansa punta tonda



07494
ansa punta piatta

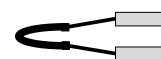

07495
ansa punta fine



07491

Set Pirografia a temperatura fissa

Contiene: base, manopola, 3 anse, libretto istruzioni per l'uso, libretto "Corso accelerato pirografia", spazzola di pulizia
Specifiche tecniche:

- Dimensioni base: cm.10x6,6x5,4 h
- 220-240 V / 50-60 Hz
- Basso voltaggio uscita 1,0 V
- Potenza 20 Watt
- Temperatura approssimativa:
550 - 600°C



07492

Set Pirografia a temperatura variabile

Contiene: base, manopola, 3 anse, libretto istruzioni per l'uso, libretto "Corso accelerato pirografia", spazzola di pulizia
Specifiche tecniche:

- Dimensioni base: cm.9,5x15,5x6 h
- 220-240 V / 50-60 Hz
- Basso voltaggio uscita 0,5 - 1,6 V
- Potenza 30 Watt
- Termostato elettronico di regolazione della temperatura
- Temperatura regolabile da 450 a 750°C



Incisore per legno

Di facile utilizzo, consente di affilare lame, eliminare la ruggine dagli oggetti, realizzare stampi o lavori di modellismo, pirografia, incisione su moltissime superfici. Indispensabile per il bricolage, ma pratico ed efficace anche per piccoli lavori industriali! Con GRINDER potrete modellare, incidere su VETRO, lavorare e levigare il LEGNO e la PLASTICA, perforare o affilare il METALLO.

1640

il set contiene: 1 incisore,
1 punta diamantata, 1 mola per incisioni,
1 punta da trapano, 2 mole per levigare,
2 ganasce, 1 scatola porta accessori,
1 adattatore AC/DC



mole di ricambio per incisore

04390

04391

● da **04392** a **04394**

Tampone per carteggiatura



Indispensabile per preparare le superfici alla decorazione rendendole lisce, prive di dislivelli o intercapedini.

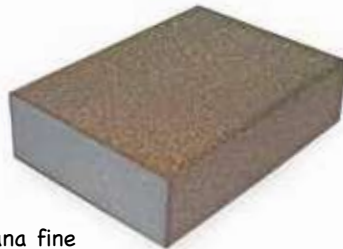

Per lavori di carteggiatura e lucidatura. Basta scegliere il foglio di carta abrasiva con la grana più indicata per la superficie da trattare, avvolgerlo intorno al tampone e fissarlo con un punto metallico. Dotato di impugnatura che facilita e rende più sicuro il lavoro di carteggiatura.



08377

tampone cm.9,8x7x2,5 h - grana fine

08378

tampone cm.9,8x7x2,5 h - grana media

●07604

busta 1 tampone per carteggiature

Carta abrasiva

Speciale carta abrasiva impermeabile resinata all'ossido di alluminio con supporto in lattice per tutti i tipi di levigatura.

6 FOGLI ASSORTITI CM.9x23

07244 - grana extrafine

grane: 1200 - 1500 - 2000
(per lucidature a specchio)

06787

grane: 100 - 180 - 240 - 320 - 400 - 1200
(per lucidature a specchio)

6 FOGLI ASSORTITI CM.23x28

06788

grane: 100 - 180 - 240 - 320 - 400 - 1200
(per lucidature a specchio)



06787



06788

Wire-wire

La tecnica wire-wire consiste nel realizzare strutture a spirale arrotolando filo di rame o ferro sull'apposita Wire Machine. Le creazioni realizzate con la tecnica del wire-wire possono essere impreziosite utilizzando perline in vetro, perle, cristalli... Con questa tecnica potrete realizzare originali ciondoli, orecchini, bracciali, collane...



● **06447**

valigetta set wire-wire

Contenuto del set: 1 avvolgitore \varnothing mm.1,5, 1 avvolgitore \varnothing mm.2, 1 avvolgitore \varnothing mm.3, 1 morsetto, 1 piegafili, 3 matassine filo di rame \varnothing mm.0,3x10 mt., 1 busta gr.30 spirale per bracciali (70-71 anelli circa), 3 scatoline gr.30, perline in vetro

Wire Machine

La Wire Machine è composta da un martelletto/manovella, che funge da perno su cui avvolgere il filo metallico, da un sostegno per il martelletto e da un morsetto che consente di fissare il sostegno al bordo del tavolo su cui si lavora.



06305

wire machine \varnothing mm.1,5

06306

wire machine \varnothing mm.2

06309

wire machine \varnothing mm.3



07099

Wire Machine
+ 2 rocchetti filo di rame



929/1



06281



06297



929/2

929/1

scatolina 20 fermagli ad anello con molla

06297

busta 20 chiusure per fermagli (art. 929/1)

929/2

scatolina 20 fermagli a barilotto

06281

busta 12 gancini per orecchini



07240

kit assortito fermagli per bigiotteria
colori: oro e platino



06296

busta gr.30 filo in metallo (si ottengono 70 spirali per bracciali)



06295

busta gr.30 filo in metallo (si ottengono 26-28 spirale per collane)

Tronchesino, pinza, piegafili



06316

tronchesino con punta in acciaio cm.11

06317

piegafili con punta tonda acuminata cm.15

06318

pinza con punta piatta
cm.12,5



Filo nylon

04404

filo nylon ϕ mm.0,4, mt.100
trasparente

100
METRI



da **06544** a **06546**

filo nylon ϕ mm.0,4x30 mt.
unicolore (vedi tabella colore)

06544 Trasparente

06546 Giallo

Cordoncino elastico

Molto indicato per realizzare
braccialetti e collanine.

06344

cordoncino elastico **BIANCO**
 ϕ mm.1x3 metri

04845

cordoncino elastico **TRASPARENTE**
mt.100 - ϕ mm.0,5



Filo di alluminio

da **06504** a **06508**

bobina filo ϕ mm. 1,5x3 mt.
unicolore

06504 Oro

06505 Argento

06506 Rosso

06507 Verde

06508 Blu



08198

filo animato argentato
metri 10 - diametro 3 mm. spessore



Fili per bigiotteria

Il filo di rame è molto indicato per il Wire Wire, mentre il filo di ferro è consigliato anche per lavori con la tavola piegafili ecc. Entrambi i materiali sono ideali per realizzare gioielli di ogni tipo, ma anche per lavoretti didattici o creativi in quanto sono molto resistenti e modellabili.

ROCCETTO DI FILO IN FERRO
 ϕ mm.0,3x23 mt. - unicolore

da **05580** a **06500**

05580 Oro

05581 Argento

05582 Rosso

05583 Verde

06500 Rame



da **06422** a **06424**

matassina filo di rame
 ϕ mm. 0,3x10 mt. - unicolore

06422 Oro

06423 Argento

06424 Blu



Paillettes



PAILLETES METALLIZZATE

930M/ASS

confezione 12 scatolette gr.8 - colori assortiti

da 930M/03 a 930M/07

confezione 12 scatolette gr.8 - unicolore

930M/03  Verde

930M/04  Giallo

● 930M/05  Turchese

930M/06  Blu chiaro

930M/07  Blu scuro



PAILLETES OPACHE

930P/ASS

confezione 12 scatolette gr.8 colori assortiti

da 930P/02 a 930P/12

confezione 12 scatolette gr.8 - unicolore

● 930P/02  Rosa

930P/03  Rosso

930P/04  Giallo chiaro

930P/05  Giallo

930P/06  Arancio

930P/07  Pesca

930P/08  Verde

930P/09  Celeste

930P/12  Nero



PAILLETES SAGOMATE METALLIZZATE

931

confezione 12 scatolette gr.8 paillettes sagomate forme e colori assortiti



PAILLETES CUCITE - ROCCHETTO MT. 10

932/1 - oro

932/2 - argento

932/3 - rosso

932/4 - blu



05584

perline vetro assortite flacone ml.25

Perline in vetro coprenti ø mm.2

da 928/01 a 928/13

scatolina gr.30 misura 10/0 - unicolore

| | | |
|--------|---|--------------|
| 928/01 |  | Bianco |
| 928/02 |  | Blu |
| 928/03 |  | Verde scuro |
| 928/04 |  | Verde chiaro |
| 928/05 |  | Azzurro |
| 928/06 |  | Giallo |
| 928/07 |  | Arancio |
| 928/08 |  | Rosso |
| 928/09 |  | Oro |
| 928/10 |  | Argento |
| 928/11 |  | Marrone |
| 928/12 |  | Nero |
| 928/13 |  | Rosa |

Perline in vetro trasparenti ø mm.2

da 927/02 a 927/20

scatolina gr.30 misura 10/0 - unicolore

| | | |
|----------|---|----------------|
| 927/02 |  | Marrone chiaro |
| 927/03 |  | Marrone scuro |
| 927/05 |  | Blu viola |
| 927/06 |  | Verde medio |
| 927/07 |  | Verde chiaro |
| 927/08 |  | Verde smeraldo |
| ● 927/09 |  | Verde scuro |
| ● 927/10 |  | Verde bandiera |
| 927/11 |  | Azzurro |
| ● 927/12 |  | Giallo limone |
| 927/13 |  | Arancio |
| 927/14 |  | Rosso |
| 927/16 |  | Violetto |
| 927/17 |  | Pesca fluo |
| 927/18 |  | Arancio fluo |
| 927/19 |  | Rosa fluo |
| 927/20 |  | Giallo fluo |



Perle in vetro ø mm.4

Con queste perle di vetro é possibile realizzare creazioni di bigiotteria di grande effetto. Le perle di vetro sono inoltre indicate per realizzare con semplicità lavoretti didattici come: collanine, ciondoli, bracciali, portachiavi, sottobicchieri, centrotavola, ecc...

da 06843 a 06963

scatola gr.30 (370 pezzi circa)
perle in vetro ø mm.4 - 6/0

| | | |
|-------|---|-----------------|
| 06843 |  | Trasparente |
| 06844 |  | Blu Trasparente |
| 06845 |  | Turchese |
| 06846 |  | Verde smeraldo |
| 06847 |  | Perla |
| 06848 |  | Corallo |
| 06849 |  | Blu viola |
| 06850 |  | Glicine |
| 06851 |  | Rosa |
| 06852 |  | Grigio nero |
| 06853 |  | Oro |
| 06854 |  | Argento |
| 06963 |  | Verde |



06927

telaio per perline
dimensioni: cm.11,5x21



06926

scatola completa di telaio, fili e perline
Dimensioni scatola: cm.44,5x34x4,5

Patchwork

Questa tecnica consiste nel ricoprire forme di polistirolo e pannelli di espanso con la stoffa. Il procedimento è molto semplice: basta incidere il polistirolo con un cutter ed infilare (con l'aiuto di un punteruolo o di una limetta) la stoffa nelle fessure precedentemente intagliate.

1540

valigetta patchwork, contiene:

- 7 tessuti assortiti cm.15x22
- 1 cutter
- 1 paio di forbici
- 1 punteruolo
- 1 pezza di ovatta cm.15x22
- 1 turbopannello cm.15x22
- 1 cartoncino rigido cm.15x22



pag.191
occhi mobili
e occhi adesivi



1550

set 7 tessuti in puro cotone fantasie assortite cm.20x25



04343

spilli per patchwork scatola gr.25 - mm.14

04341

spilli per sarti in acciaio scatola gr.25 - mm.32

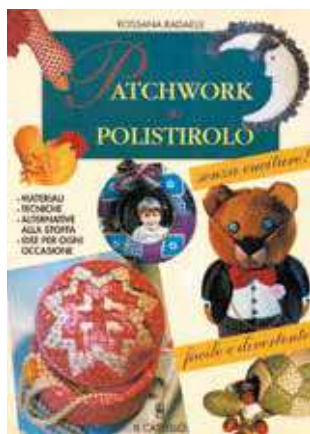

GUIDA CREATIVA

08221

"Patchwork per polistirolo"

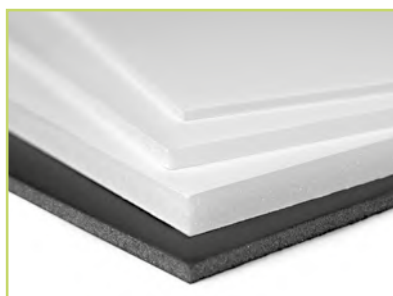

TURBOPANNELLO espanso bianco accoppiato a cartoncino

727/2

cm.50x70 bianco - mm.5

727/3

cm.70x100 bianco - mm.5



OVATTA

1552

ovatta cm.50x150 (per dare un effetto più morbido e "imbottito" ai lavoretti)



Mosaico in pietra

Le pietre si applicano facilmente con l'ausilio di una colla forte. Sulle tavole prestampate sono raffigurati disegni con contorni ben delineati, facili da riempire con le pietre seguendo i suggerimenti sui colori da utilizzare.

da 05926 a 06205

busta gr.100 sassolini per mosaico

- 05926**  Bianco
- 05927**  Giallo limone
- 05928**  Giallo ocra
- 05929**  Becco d'oca
- 05930**  Arancio
- 05931**  Rosso
- 05932**  Ciclamino
- 06203**  Rosa carne
- 05934**  Verde chiaro
- 05935**  Verde medio
- 05936**  Verde scuro
- 05937**  Verde smeraldo
- 05938**  Verde acqua
- 05939**  Turchese
- 05940**  Blu cielo
- 06202**  Blu oltremare
- 05941**  Blu scuro
- 05942**  Viola
- 06205**  Terra di Siena
- 05943**  Terra
- 06204**  Beige
- 05944**  Argento
- 05945**  Oro
- 06120**  Nero



06239

confezione 5 tavole serigrafate, soggetti assortiti dimensioni: cm.20x30



1584

pinzetta in metallo
Ideale per posizionare con la massima cura i sassolini più piccoli



10002

set mosaico in pietra: tavolozza ø cm.31 (12 scomparti) + mosaico in pietra (12 colori assortiti 100 gr. cad.)

06240

scatola mosaico in pietra, contiene: 2 tavole in legno predisegnate cm.20x30, 2 cartoline-guida colori, 1 pinzetta, 1 flacone di colla, 20 bustine gr.100 mosaico in pietra, colori assortiti



Plastomosaico

Con queste tessere colorate anche i più piccoli potranno cimentarsi nella tecnica del mosaico. Il PlastoMosaico aiuta a sviluppare la scelta dei colori, la coordinazione e la creatività, stimolando il bambino a cercare nuove immagini e combinazioni.

**400
PEZZI**

11942

400 tessere cm.1,5x1,5
colori assortiti + base
di lavoro cm.22x22
(in plastica)



Mosaico in plastica "finitura a pietra"

Caratteristiche:

taglio: con una tenaglia o tronchesino;

sicurezza: non produce schegge taglienti;

peso: riduce dell'80% il peso del pannello



1,5x1,5 CM

da 11857/01 a 11857/20

busta 50 tessere mosaico - unicolore
cm.1,5x1,5 - spessore 3,6 mm.



INDICATO PER I BAMBINI

| | | |
|-----------------|--|----------------|
| 11857/01 | | Bianco titanio |
| 11857/02 | | Beige |
| 11857/03 | | Tortora |
| 11857/04 | | Carnicino |
| 11857/05 | | Rosso |
| 11857/06 | | Rosso ossido |
| 11857/07 | | Terra D'ombra |
| 11857/08 | | Terra di Siena |
| 11857/09 | | Ocra gialla |
| 11857/10 | | Arancio |

| | | |
|-----------------|--|----------------|
| 11857/11 | | Giallo Marte |
| 11857/12 | | Verde salvia |
| 11857/13 | | Verde chiaro |
| 11857/14 | | Verde scuro |
| 11857/15 | | Blu Prussia |
| 11857/16 | | Blu Madonna |
| 11857/17 | | Azzurro chiaro |
| 11857/18 | | Grigio |
| 11857/19 | | Grigio fumé |
| 11857/20 | | Nero |

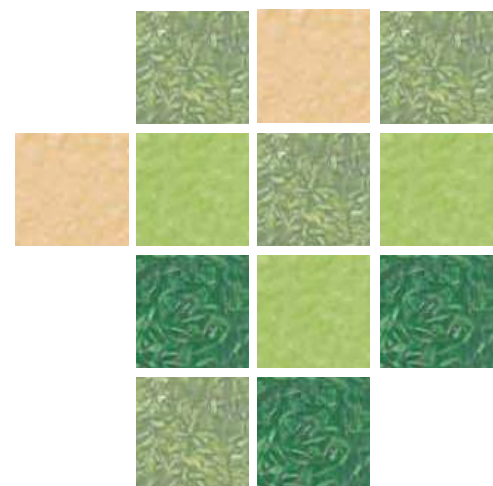
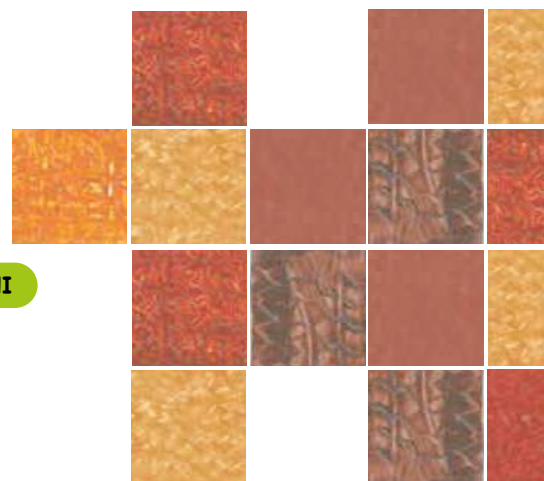

Mosaico in plastica "veneziano"

Caratteristiche: **taglio**: con una tenaglia o tronchesino; **sicurezza**: non produce schegge taglienti; **peso**: riduce dell'80% il peso del pannello; **colori**: ben 52, contraddistinti dalla lettera "C" per i colori coprenti e dalla lettera "T" per i trasparenti.



TESSERE COPRENTI

1x1 CM

da 1330/C05 a 1330/C50

busta 80 tessere mosaico cm.1x1 - unicolore

- 1330/C05 Azzurro chiaro
- 1330/C06 Blu Madonna
- 1330/C07 Blu oltremare
- 1330/C08 Blu Prussia
- 1330/C13 Verde cinabro
- 1330/C14 Verde terra
- 1330/C15 Verde scuro
- 1330/C16 Turchese
- 1330/C19 Bianco zinco
- 1330/C20 Bianco titanio
- 1330/C21 Grigio sabbia
- 1330/C22 Grigio scuro
- 1330/C23 Nero
- 1330/C26 Giallo limone
- 1330/C27 Giallo Marte
- 1330/C28 Giallo mais
- 1330/C29 Terra naturale
- 1330/C30 Bruno
- 1330/C34 Arancio
- 1330/C35 Rosso Vermiglione
- 1330/C36 Oro antico
- 1330/C37 Argento antico
- 1330/C38 Rame
- 1330/C40 Rosa carne
- 1330/C41 Rosa medio
- 1330/C42 Rosa forte
- 1330/C43 Fuxia
- 1330/C44 Viola
- 1330/C45 Travertino
- 1330/C46 Volterra
- 1330/C47 Ocra gialla
- 1330/C48 Orobico
- 1330/C49 Terra di Siena
- 1330/C50 Terra ombra



TESSERE TRASPARENTI

1x1 CM

da 1330/T01 a 1330/T39

busta 80 tessere mosaico in materiale acrilico cm.1x1 - unicolore

- 1330/T01 Azz. acqua
- 1330/T02 Azz. cielo
- 1330/T03 Turchese
- 1330/T04 Blu cobalto
- 1330/T09 Verde acqua
- 1330/T10 Verde chiaro
- 1330/T11 Verde smeraldo
- 1330/T12 Verde scuro
- 1330/T17 Kristal
- 1330/T18 Kristal fumè
- 1330/T24 Giallo chiaro
- 1330/T25 Giallo ocra
- 1330/T31 Arancio chiaro
- 1330/T32 Arancio
- 1330/T33 Rosso rubino
- 1330/T39 Lilla



INDICATO PER I BAMBINI

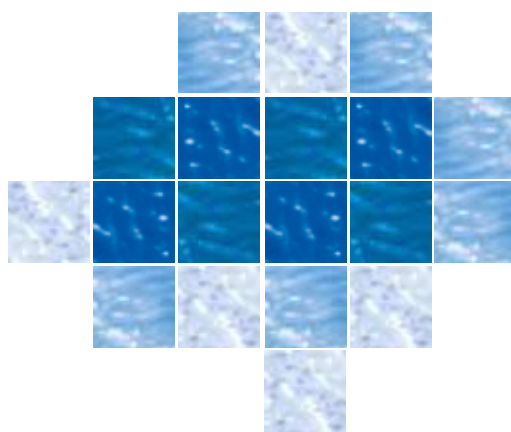

09720

tavolozza ø cm.31 (12 scomparti) completa di 720 tessere mosaico veneziano colori assortiti + 1 pinzetta

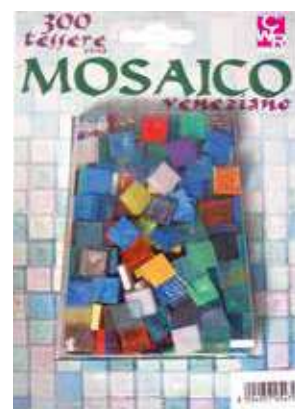

05479

blister 300 tessere in plastica per mosaico - colori assortiti

Cromomosaico

Leggere e facili da incollare, queste tessere di cartone sono indicate per realizzare decorazioni e mosaici su biglietti augurali, lampade, ghirlande, scatoline e ogni altro oggetto.



1,5x1,5 CM



● da 06742 a 06743

busta 25 tessere cromomosaico olografico unicolore cm.1,5x1,5

06742  Oro

06743  Argento

da 06736 a 06739

busta 25 tessere cromomosaico metallizzato unicolore cm.1,5x1,5

06736  Fuxia

06738  Turchese

06739  Verde

1000
PEZZI

IN CARTONCINO



1,5x1,5 CM

06829

busta 1000 tessere cm.1,5x1,5 cartoncini assortiti in 6 colori

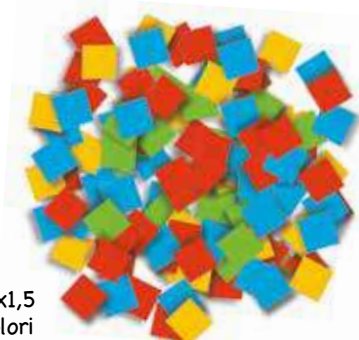

490
PEZZI

IN GOMMA EVA



1x1 CM

05855

busta 490 tessere mosaico in EVA cm.1x1 (10 fogli colori assortiti)



Mosaico ceramico

05368

scatola completa per mosaico, contiene: 4 stampi per tessere mosaico (con una sola colata di ceramica otterrete 128 tessere), 1 kg. di polvere di ceramica, 10 gessetti colorati (per colorare l'impasto di ceramica)



Stampi per tessere mosaico

Stampi a colata utilizzabili con polvere di ceramica, sapone, cera...

03652

busta 2 stampi stampo: cm.12x22

05656

busta 2 stampi stampo: cm.12x22



03652

05656

Stucco Acril

Utilizzato nella tecnica del mosaico per riempire le fughe, ossia le interpedini tra una tessera e l'altra. Stuccando le fughe si otterrà una superficie livellata e omogenea.

05443

barattolo ml.700 stucco (base acqua)



Confezioni regalo

Speciale carta di alta qualità. Resistente, tenace, duttile e robusta. Ideale per imballare ogni sorta di oggetto e quindi particolarmente indicata per magazzini, uffici postali, ecc...

CARTA DA PACCO

GR.80 BIANCA

- 08159** - cm.35x20 mt. (rotolo)
- 09144** - cm.70x10 mt. (rotolo)
- 1020** - cm.70x20 mt. (rotolo)
- 07106** - cm.70x50 mt. (rotolo)
- 07107** - cm.100x10 mt. (rotolo)
- 07108** - cm.100x50 mt. (rotolo)
- 05680** - cm.150x10 mt. (rotolo)
- 09690** - cm.100x150 (fogli 1 kg.)
- 1021** - cm.100x150 (fogli 5 kg.)
- 1024** - cm.100x150 (20 fogli piegati)

ACID FREE

GR.90 BIANCA

- 08023** - cm.42x50 mt. (rotolo)

GR.100 BIANCA

- 08777** - cm.100x20 mt. (rotolo)
- 04168** - cm.100x150 (4 fogli piegati)



GR.60 AVANA

- 1027** - cm.70x5 MT. (rotolo)
- 05703** - cm.70x20 MT. (rotolo)
- 11940** - cm.100x10 MT. (rotolo)
- 11941** - cm.100x25 MT. (rotolo)

GR.80 AVANA

- 1031** - cm.75x100 (20 fogli piegati)
- 1023** - cm.100x150 (20 fogli)
- 09691** - cm.100x150 (fogli, 1 KG.)
- 1022** - cm.100x150 (41 fogli, 5 KG.)
- 08778** - cm.100x50 MT. (rotolo, 4 KG.)

CARTA DA REGALO



09432

busta 10 fogli cm.70x100
assortimento generico



ALTA QUALITÀ

09433

busta 10 fogli cm.70x100
assortimento Natale







Fiocchi rapid

Facili da comporre, usando più o meno nastro a seconda della grandezza che si vuole ottenere.

da 07388 a 07391

confezione 30 fiocchi RAPID
larghezza nastro mm.31
dimensione fiocco ø cm.13
unicolore (vedi cartella colori)

Fiocchi RAPID nastro mm.31x13 ø

- 07388**  Bianco
- 07389**  Azzurro
- 07390**  Rosa
- 07391**  Rosso



da 07392 a 07394

conf. 30 fiocchi RAPID METALLIZZATI
larghezza nastro mm.31
dimensione fiocco ø cm.13
unicolore metallizzato (vedi cartella colori)

Fiocchi RAPID metallizzati nastro mm.31x13 ø

- 07392**  Oro
- 07393**  Argento
- 07394**  Rosso



pag.280
forbici

Stelle autoadesive

STELLE ADESIVE ø cm.5

07395
PACK SCUOLA 152 stelle
larghezza nastro mm.10, ø cm.5
colori assortiti

07396
PACK SCUOLA 152 stelle metal
larghezza nastro mm.10, ø cm.5
colori assortiti: oro, argento, rosso

STELLE ø cm.8

07397
PACK SCUOLA 40 stelle
larghezza nastro mm.19, ø cm.8
colori assortiti

07398
PACK SCUOLA 40 stelle metal
larghezza nastro mm.19, ø cm.8
colori assortiti: oro, argento, rosso



Rocchettini



07414
PACK SCUOLA 24 rocchettini
mt.10x10 mm. larghezza colori assortiti





07415
PACK SCUOLA 24 rocchettini
mt.10x10 mm. larghezza
colori metallizzati: oro, argento, rosso









Soffietti

Nastri larghi per realizzare con facilità fiocchi imponenti da applicare su cesti, grossi pacchi dono, ecc...

da **07399 a 07404**
soffietto rocchetto mt.100x50 mm.

- 07399**  Bianco
- 07400**  Giallo
- 07402**  Rosso
- 07403**  Azzurro
- 07404**  Verde

da **07405 a 07410**
soffietto rocchetto mt.250x10 mm.

- 07405**  Bianco
- 07406**  Giallo
- 07407**  Rosa
- 07408**  Rosso
- 07409**  Azzurro
- 07410**  Verde



da **07411 a 07413**
soffietto rocchetto mt.250x10 mm.
colori metallizzati

- 07411**  Oro
- 07412**  Argento
- 07413**  Rosso

pag.279
distributore
da banco

Biglietti con finestre

Indispensabili per ogni occasione! La finestra consente di realizzare originali decorazioni per personalizzare i propri auguri.



07354

● **07354**

set 50 buste cm.11,5x16 crema

07351

set 50 cartoncini avorio
cm.10,5x15 gr.250

07352

set 50 cartoncini bianco perla
cm.10,5x15 gr.300

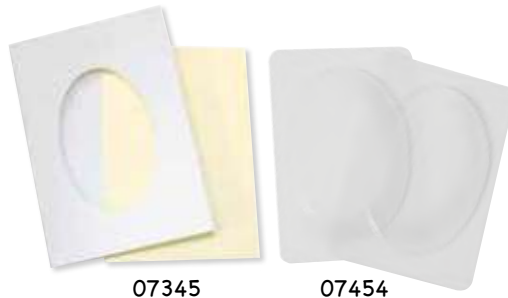

07345

07454

Set 10 bigliettini doppi con finestra
cm.10,5x15+10 cartoncini

07345 - avorio

07346 - perlescenti

07347 - bianco perla

● **07454**

set 10 finestre trasparenti 3D ovali



07348

Set 10 bigliettini doppi con finestra
+ 10 cartoncini cm.10,5x15 colori
perlescenti gr.300

07348 - soggetti natalizi

07350 - decorazioni assortite

Finestre 3D

Grazie alle finestre trasparenti, disponibili in differenti forme, potrete realizzare biglietti tridimensionali per ogni occasione. Basta decorare il cartoncino e applicare la finestra servendosi di nastro biadesivo.

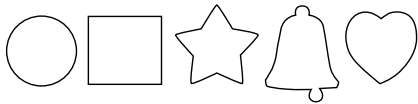

06817

set 5 finestre per decorazioni
forme assortite: tondo, rettangolo,
stella, campana, cuore - cm.7x7 circa



Punzecchio



EF0047

set animali, cm.10,5x14,4

Ogni set contiene: 5 buste, 5 cartoncini,
5 diversi soggetti predisegnati, ago e fili.



PR0508

maschera ovale cm.10x13,3
Mascherina in acciaio per
realizzare cornici utilizzando
la tecnica del punzecchio.

PR0100

punteruolo per punzecchio cm.14,5



PR0209



PR0211



PR0212

Ogni set contiene: 4 buste, 4 cartoncini, 4 diversi soggetti con
cornici predisegnate da punzecchiare. Dimensioni: cm.10,5x15

PR0209 - set nascita

PR0211 - set animali

PR0212 - set matrimoni

Sacchetti di carta

Busta in carta, materiale carta Kraft bianco 150 gr.



SACCHETTO CHRISTMAS - 25 PEZZI

● **11308** - cm.18x8x23



SACCHETTO ORO - 25 PEZZI

11305 - cm.25x11x20

11306 - cm.25x11x36

11307 - cm.36x12x40



Sacchetto plastificato - conf. 25 pezzi

Monopatinata 130 gr.
Plastificazione lucida.
Colore ROSSO.

11298 - cm.16x8x24

11299 - cm.25x11x31

11300 - cm.36x12x40



Resistenti, con solide maniglie arrotolate simil cordoncino. Ideali per essere personalizzati. Possono essere dipinti con tutti i tipi di colore e decorati con glitter, nastri, rafia, ecc...

Sacchetto in carta BIANCO - conf. 25 pezzi

Borsa a soffiato in carta kraft, maniglia in carta ritorta.

11284 - cm.16x8x21

11285 - cm.22x10x27

11286 - cm.26x12x36

11287 - cm.36x12x41

Sacchetto in carta AVANA - conf. 25 pezzi

Borsa a soffiato in carta kraft, maniglia in carta ritorta.

11288 - cm.16x8x21

11289 - cm.22x10x27

11290 - cm.26x12x36

11291 - cm.36x12x41

Buste zip

Richiudibili.



20 buste con chiusura zip

- 1794** - cm.7x12
- 1795** - cm.10x12
- 1800** - cm.10x20
- 1801** - cm.20x30
- 1802** - cm.30x45



Buste milleusi

50 buste milleusi con chiusura adesiva

- 03660** - cm.13x28
- 03661** - cm.15x23
- 03662** - cm.22x30
- 03663** - cm.25x33
- 03664** - cm.30x38
- 04941** - cm.31x43
- 04919** - cm.37x53
- 04918** - cm.52x73

100 buste milleusi

- 03655** - cm.13x30
- 03656** - cm.15x25
- 03657** - cm.22x32
- 03658** - cm.25x35
- 03659** - cm.30x40



Scatola da decorare

Lo speciale cartoncino con cui sono realizzate queste scatole supporta perfettamente i collanti e ogni tipo di colore: olio, tempera, acrilici... Divertitevi a disegnare sulla scatola e a decorarla!



Decorate la scatola Dekò a vostro piacimento!

07103x6

6 scatole dekò con coperchio bianco
cm.15x15x4 h

Scatole in cartone

Robustissime scatole facili da assemblare senza bisogno di colle o nastro adesivo! Semplici da decorare e rivestire, sono ideali per arredare le aule o la casa e riporre ogni cosa.



07455x10

10 scatole da assemblare cm.22x17x13 h (A5)
con coperchio, fornite stese - colore bianco

07456x10

10 scatole da assemblare cm.31x23x14 h (A4)
con coperchio, fornite stese - colore bianco

Scatole in cartoncino

Scatole in cartoncino gr.450. Facili da assemblare senza utilizzare colle o nastro adesivo, supportano ogni tipo di colore e materiale decorativo.



07450x10

10 scatole cm.14x9,5x3 h - bianco

07451x10

10 scatole cm.8,5x5,6x3,3 h - bianco

07452x10

10 scatole cm.7x5x3 h - bianco

07453x10

10 scatole cm.7x7x11 h - bianco

Paglietta cellophane



10340

1768

10340

kit paglietta neutra + foglio trasparente
gr.150 cm.100x130 + fiocco rosso

1768

confezione paglietta neutra gr.300

09902

confezione paglietta neutra kg.1

1768/5

confezione paglietta neutra kg.5

Truciolo colorato in carta

pag.211
rafia colorata

BUSTA GR.100 - TRUCIOLO

1767/1 - rosso

1767/2 - giallo

1767/3 - verde



Cellophane trasparente



06068

5 rotoli cm.70x500 - colori trasparenti assortiti

ROTOLO CELLOPHANE CM.70 X 500

10827 - trasparente

10828 - giallo

10829 - rosso

10830 - blu

10831 - verde

Plastica trasparente



1765/3

3 FOGLI CM.100 X 130

1766/3

trasparente

1765/3

fantasia



1770/25

rotolo cm.100x25 mt. trasparente

25 FOGLI CM.100 X 130

1765/25

trasparente neutro

1764/25

trasparente stampata fantasia

Adesivi fotografici



12595
6 fogli adesivi farfalle
con 50 adesivi cad.
foglio: mm.218x318



12596
6 fogli adesivi animali
con 50 adesivi cad.
foglio: mm.218x318



12597
6 fogli adesivi animali selvaggi
con 50 adesivi cad.
foglio: mm.218x318

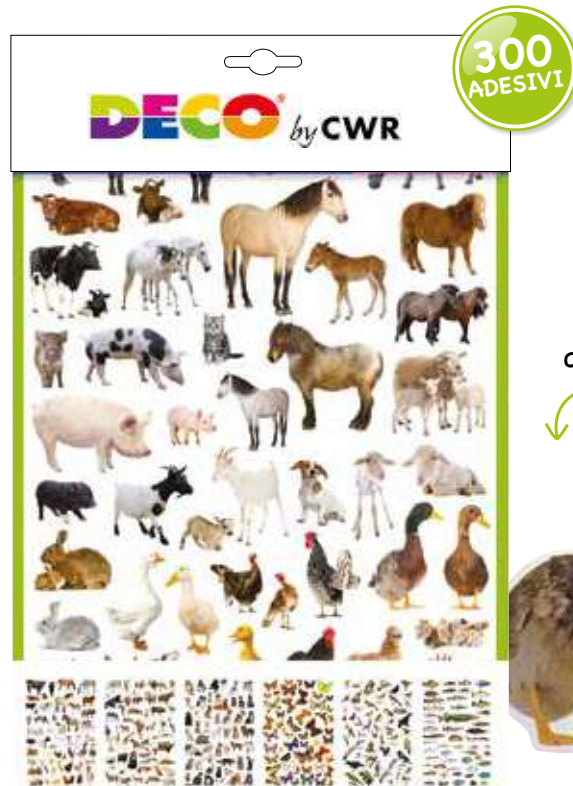

12598
adesivi animali assortiti
6 fogli diversi
con 50 adesivi cad.
foglio: mm.218x318

Adesivi in rotolo

2000
ADESIVI

12603/1
occhietti adesivi cartoon
(2000 PEZZI)
6 colori e motivi diversi
dimensioni: mm.45



2000
ADESIVI

12603/2
occhietti adesivi
DELLE EMOZIONI
(2000 PEZZI) 6 motivi diversi
dimensioni: mm.45



450
ADESIVI

12603/3
fiori e mandala adesivi
(450 PEZZI)
8 colori e motivi diversi
dimensioni: mm.48



870
ADESIVI

12603/4
cuori adesivi (870 PEZZI)
colori assortiti



Adesivi

Ideali anche per chiudere e impreziosire i pacchetti regalo.
Ogni foglio (cm.11,5x15) è confezionato in busta singola.

FOGLIO OLOGRAFICO

- 910** - stelle oro
- 912** - stelle rosse
- 913** - comete oro
- 914** - campane
- 915** - cuori rossi



910

912

913

914

915



ETICHETTE CM.11X15 BUSTA 10 FOGLI

- 390-4/10** - stelle argento
- 390-5/10** - stelle oro
- 390-6/10** - cuori oro
- 390-7/10** - cuori rossi



ETICHETTE CM.11X15 BUSTA 2 FOGLI

- 390/4** - stelle argento
- 390/5** - stelle oro
- 390/6** - cuori oro
- 390/7** - cuori rossi



ROTOLO 200 ETICHETTE OVALI

- 387/2**
cm.2,2x3,5 "Auguri"
- 387/3**
cm.2,2x3,5 "Buone Feste"



- 6 fogli ADESIVI mm.120x75**
12599/1
stelle oro ø 13 mm (288 PEZZI)
- 12601/1**
stelle oro ø 25 mm (108 PEZZI)



- 6 fogli ADESIVI mm.120x75**
12599/2
stelle argento ø 13 mm (288 PEZZI)
- 12601/2**
stelle argento ø 25 mm (108 PEZZI)



ADESIVI STELLE

- 09166**
conf. 6 fogli etichette
STELLE colore: oro/argento
busta cm.8x15

Adesivi

146
CUORI
ADESIVI

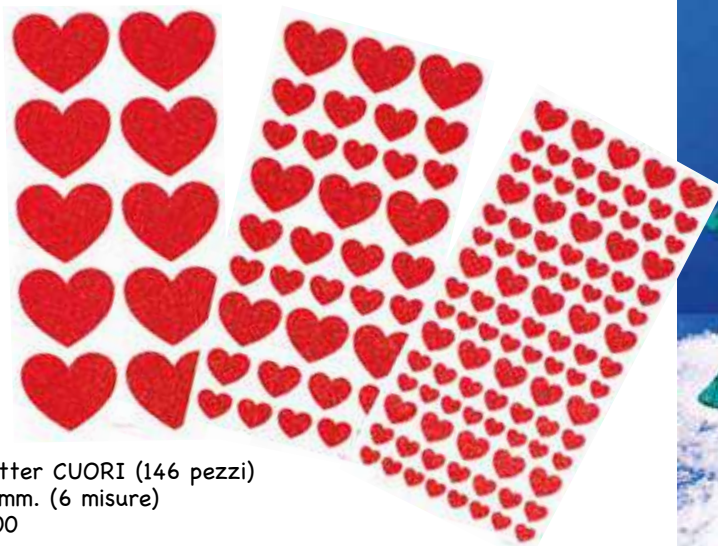

NOVITA'

12926

3 fogli adesivi glitter CUORI (146 pezzi)
cuori: da 9 a 45 mm. (6 misure)
foglio: mm.100x200



132
STELLE
ADESIVE



NOVITA'

12927

set 4 fogli stelle in EVA GLITTER **ADESIVE** (132 pezzi)
dimensioni stella: da 15 a 34mm.
foglio mm.100x200 - 4 FOGLI (2 oro, 2 argento)



NOVITA'

12925

set 10 fogli adesivi Natalizi
dimensioni: da 12 a 40mm.
foglio mm.218x318



ADESIVI IN EVA

05552

conf. 12 bustine adesivi
(lettere e numeri in EVA)
busta cm.7,5x14



ADESIVI "BUBBLE"

05547

conf. 12 bustine adesivi
soggetti assortiti
busta cm.5,5x14,5

Etichette adesive



ETICHETTE ADESIVE

07338

confezione 48 etichette cm.3,5x6,5
soggetti pasquali

07340

confezione 48 etichette cm.3,5x6,5
soggetti generici

07338

07340

Adesivi olografici



916



917



918



05550



05548

FOGLIO CM.11,5X15

916 - soggetti natalizi 1

917 - soggetti natalizi 2

918 - abeti

920

busta 10 fogli soggetti assortiti

05550

conf. 12 bustine adesivi "Laser"
soggetti natalizi olografici assortiti
Foglio: cm.5,3x23

05548

conf. 12 bustine adesivi soggetti natalizi
assortiti. Foglio: cm.10x17

Adesivi metallizzati

Queste etichette adesive riproducono esattamente la sagoma e i contorni del soggetto: è quindi possibile colorare all'interno delle figure o impreziosirle ulteriormente con l'aiuto di glitter, sabbia, microsfere. Ideali per decorare e personalizzare biglietti d'auguri, addobbi, carta da lettere, carta da regalo, scrapbooking e moltissimi altri oggetti.

da 03597 a 03610

foglio cm.10x23



03597
lettere
oro

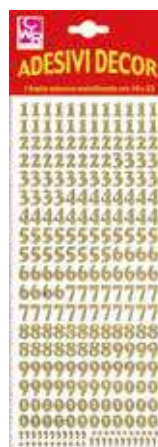

03598
numeri
oro



03599
farfalle
oro



03606
cuori
oro



03607
angeli
rosso/oro



03608
soggetti
natalizi



03609
campane
verde



03610
calze
rosso/oro



05529
Pasqua
oro

da 03600 a 05528

foglio cm.10x23

**OFFERTA SPECIALE PER
ESAURIMENTO SCORTE**



03600
uccelli
oro



03602
orsetti
azzurro



03603
rose
oro



03604
fiori
oro



05528
ondine
rame

Speciale party

pag.596
giochi ricreativi



08898

conf. 100 palloncini ø cm.24
colori assortiti

da 10444 a 10449

conf. 100 palloncini ø cm.24 unicolore

10444  bianco

10445  giallo

10446  rosso

10447  verde

10448  azzurro

10449  rosa

08902

pompa per palloncini



11319

gonfiatore elettrico per palloncini
cm.13x14x13 h

Adatto a gonfiare palloni in lattice e foil. Principali caratteristiche: gonfiaggio immediato dei palloni: con semplice pressione manuale sulla valvola il gonfiatore si avvierà automaticamente.



08900

confezione 100 palloncini ad acqua
palloncino ø cm.8



08901

confezione 100 palloncini da modellare
palloncino cm.4x13



pag.157
maschere da
decorare

254 Materiale creativo



Carnevale



67893
stelle filanti 3 rotoli in busta



67820 - coriandoli standard gr.200

67835 - coriandoloni gr.300



614/3
spray ml.150 schiuma



70565
confezione **72 cappelli mignon metallizzati**



73183x25
25 nasi clown in plastica



24 FARFALLE
CON ELASTICO (in plastica)

74020x24

colore nero

74015x24

colori assortiti



09832

set trucchi teatrali 6 pastelli
lung. mm.62 - colori assortiti



10753 a 10756

bombola spray lacca colorata
per capelli ml.100

10753 - bianco **10754** - verde

10755 - rosso **10756** - blu

Natale

Carta per fondali

Diverse versioni di carte per ambientare al meglio presepi e scene di natività, e per allestire vetrine, scenografie ecc...



2137

fondale in carta per presepi cm.70x125 - in rotolo



08931

fondale metallizzato con paesaggio innevato cm.70x100
minimo acquistabile: 25 pezzi

09190

fondale metallizzato con paesaggio innevato cm.70x100
in rotolo - minimo acquistabile 25 pezzi



2148

fondo cielo stellato metallizzato con stella cometa
cm.70x100 - minimo acquistabile: 25 pezzi



2149

fondo cielo stellato metallizzato cm.70x100 in rotolo
minimo acquistabile: 25 pezzi

09191

fondo cielo stellato metallizzato cm.70x100 in rotolo
minimo acquistabile: 25 pezzi

Carta per fondali double face

Una versione originale della classica carta millerighe unicolore. **Double face:** da un lato è unicolore, mentre dall'altro è stellato. Carta tenace e resistente.



05749

fondo cielo stellato mt.15x70 cm. - in rotolo

256 Materiale creativo

Capanna presepe 3D



DA COSTRUIRE



12122

set capanna presepe 3D con accessori
dimensioni: cm.28x19x22

Set per presepe



09571

set TRIS presepe: terra del deserto cm.50x70
+ cielo stellato vellutato cm.70x100
+ carta roccia cm.70x100

09285

set 2 rotoli: terra del deserto cm.50x70
+ cielo stellato cm.70x100 vellutato

Carta roccia



2138/2

busta 2 fogli carta roccia
stampata in 4 colori
cm.70x100 - piegati



2142

carta roccia vellutata cm.70x100 in rotolo



10335x5

5 fogli carta roccia arricciata DIPINTA A MANO cm.70x100



CON UN SEMPLICE GESTO...
OTTERRETE L'EFFETTO ROCCIA!

PRIMA



DOPO



08923

10 fogli carta roccia cm.70x100 in rotolo

Terra del deserto



09284

rotolo effetto terra del deserto cm.50x70



Prato artificiale



2140

rotolo finto muschio cm.50x70



2143

rotolo prato artificiale cm.50x70

Effetto pietra



10336

rotolo effetto pietra cm.50x70



10337

ghiaia busta gr.500

Sabbia



10339

sabbia busta gr.70



10338

erbetta busta gr.70

258 Materiale creativo

Bombole spray

*La grafica delle bombole potrebbe variare

pag.82
stencil Natalizi



615/1
vernice spray
ml.150 - oro



615/2
vernice spray ml.150
argento



614/1
spray ml.150
neve



Pasqua e Halloween

Uova da decorare

Non si rompono, hanno una superficie porosa che supporta ogni tipo di colore o collante, e consentono di ottenere gli stessi risultati realizzabili su un uovo vero! Esistono tantissime tecniche per decorare le uova: batik, stencil, découpage, timbri, foglia d'oro, mosaico, marmorizzazione, uova di Praga, ecc... Per ottenere risultati strepitosi consigliamo di abbellire le uova con carta riso, carta velina, tovaglioli, oppure utilizzando Deco Effetti, paste da modellare o a rilievo, Window Color...

pag.146
uova e accessori



pag.139 forme e
vetrini Kristall



07151
scatola 4 fantasmini da decorare cm.7x8 h
Fantasmini in materiale plastico che supportano ogni tipo di colore o collante. Personalizzate le vostre "mostruose" creazioni utilizzando occhietti mobili, capelli finti, paste a rilievo.



65123x4
4 ragnatele - gr.50

Confezioni regalo **259**

Bicchieri, ciotole e vassoi

USA e RIUSA

Prodotti lavabili e riutilizzabili

Pratici bicchieri in plastica resistenti e sicuri. Le ciotole, vaschette e vassoi sono resistenti a microonde.



1161/6
confezione 6 bicchieri
ml.330 colori kristall
assortiti



04799
confezione 3
bicchieri ml.700



06421
confezione 3 bicchieri
infrangibili grandi ml.600



1168/12 - conf. 12 bicchieri ml.200
06710 - conf. 6 bicchieri ml.250
1160/12 - conf. 12 bicchieri ml.330



05690
set 12 bicchieri ml.125
in materiale acrilico
per bambini - colori assortiti



1163/6
conf. 6 bicchieri
ml.350 colori assortiti



06080
vassoio cm.26,5x39,5

● **2785/3**
vassoio cm.32x46



06220
6 tazze ml.350
ø cm.12x6 h

04801
6 ciotole ø cm.9x4 h



04802
confezione 6 vaschette
con coperchio
dimensioni: cm.10x14x6 h

Piatti rigidi \varnothing cm.22,5

USA e RIUSA - Prodotti lavabili e riutilizzabili
Pratici bicchieri in plastica resistenti e sicuri.



1286/B
conf. 10 piatti colore bianco



08102
confezione 4 piatti - colori assortiti

1286/R
confezione 10 piatti - colore rosso



1286/V
confezione 10 piatti - colore verde



1286/BL
confezione 10 piatti - colore blu



1286/AZ
confezione 10 piatti - colore azzurro



1286/G
confezione 10 piatti - colore giallo



1286/RS
confezione 10 piatti - colore rosa

IDEALI
PER LE FESTE
DEI BAMBINI!



1254/4B
conf. 4 sottopiatti cm.30x30 colore blu
1254/4G
conf. 4 sottopiatti cm.30x30 colore giallo



04800
conf. 6 piatti rigidi per pizza
 \varnothing cm.32
colore bianco



Tovaglia in carta



07195

12 tovagliette predisegnate
carta Paglia cm.27x37



09756

conf. 500 tovagliette in carta
cm.30x40 - gr.45

BIANCA
PRATICA E
MONOUSO!



TOVAGLIA IN CARTA - mt.1,20x8

06185  Rosso

06186  Blu

06187  Giallo

05464

busta 4 fermatovaglie



Posate

1280

conf. 10 forchette

1281

conf. 10 coltelli

1282

conf. 10 cucchiari

09681

conf. 100 cucchiaini



Tovaglioli

Tovaglioli asciugatutto,
morbidi al tatto ma molto
tenaci grazie all' intreccio
a trama fitta, che garanti-
sce una grande capacità di
assorbimento.

MORBIDI E
RESISTENTI!



da **05716** a **05719**

confezione 50 tovaglioli cm.33x33



● **05716**

limoni



05717

soggetti marini



● **05718**

paesaggio



● **05719**

frutta

pag.223
tovaglioli
di carta

Marker OHP

Marker con punta sintetica indeformabile, studiati per scrivere su fogli trasparenti per proiezione, diapositive, cd, pellicole, lucidi, ecc... Inchiostro permanente resistente all'acqua, cancellabile con alcol su superfici non porose.

SCRIVE SU FILM, VETRO, PLASTICA, METALLO, LEGNO.

BUSTA 4 MARKER COLORI ASSORTITI

C7937/F4 - punta fine

C7936/M4 - punta media

C8938/B4 - punta grossa



punta fine
tratto mm.0,6



punta media
tratto mm.1



punta grossa
tratto da mm.1
a mm.3



MARKER COLORE NERO

C7937/FN - punta fine

C7936/MN - punta media

C8938/BN - punta grossa

Marker calligraphy

Dal tratto deciso e modulabile, che consente una scrittura precisa e ricca di dettagli. La punta in feltro a scappello crea un tratto di varie larghezze che rende la calligrafia molto elegante. Inchiostro nero a base acqua.

C8772

busta 4 marker Calligraphy colore nero
punte assortite nelle diverse larghezze



Calligrafia

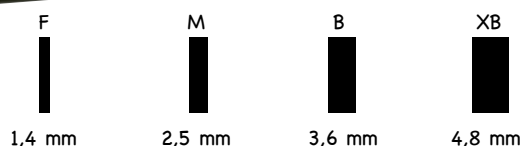

Marker metal

MARKER FELTRO - **PUNTA FINE MM.1**

C2670/1 - oro

C2670/2 - argento

MARKER FELTRO - **PUNTA MEDIA MM.1,8/3**

C2690/1 - oro

C2690/2 - argento

C2690/BL2

blister 1 marker oro + 1 argento

PUNTA MEDIA MM.1,8/3

Inchiostro permanente su carta e materiali porosi.
Semi-permanente su vetro, metallo, plastica. Punta tonda.



Marker vernice

MARKER PUNTA GROSSA

06129 - oro

06130 - argento

06131 - bianco



Marker cancellabili

Asciugano rapidamente. È sufficiente passare un panno o un cancellino per eliminare con facilità il tratto dalle lavagne. Punta tonda, tratto mm.2,5



pag.310
lavagne

- 06135 - blu
- 06136 - nero
- 06137 - rosso
- 06138 - verde
- 07763
busta 4 marker colori assortiti



- 12768
confezione 12 marker per lavagne con cancellino e magnete. Inodore, asciuga rapidamente.



Marker base acqua

Marker con inchiostro a base acqua. Per uso su carta. Il colore non trapassa la carta.

- PUNTA SPATOLA
- TRATTO DA MM.1 A 4,6
- C8860/R - rosso



Marker permanenti

Inchiostro a base alcool. Scrivono su carta, gomma, pelle, plastica, metallo, ecc... Resistente all'acqua.

10 MARKER PUNTA OGIVA

TRATTO DA MM.1 A 3

- 12040/1x10 - nero
- 12040/2x10 - blu
- 12040/3x10 - rosso
- 12040/4x10 - verde

NOVITA'

- 12037/1 - 2 marker nero
- 12037/2 - 2 marker blu

10 MARKER PUNTA SCALPELLO

TRATTO DA MM.1 A 5

- 11682/1x10 - nero
- 11682/2x10 - blu
- 11682/3x10 - rosso
- 11682/4x10 - verde

NOVITA'

- 11679/1 - 2 marker nero
- 11679/2 - 2 marker blu



MAXI Marker

PUNTA SCALPELLO
TRATTO DA MM.1 A 10

- 04177 - nero
- 04178 - rosso
- 04179 - blu



Penne

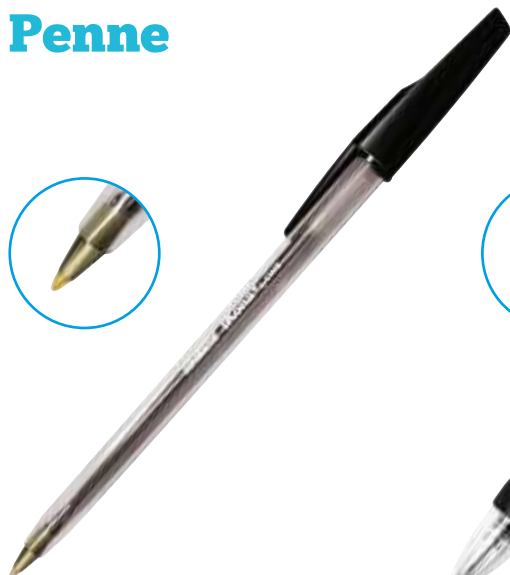

PENNE A SFERA

Dal tratto morbido e fluido.

04490x50

50 penne - blu

04491x50

50 penne - nero

04492x50

50 penne - rosso

11668

CONFEZIONE SCUOLA
12 penne colori assortiti

09803

barattolo SCUOLA 24 penne
(rosso, nero, blu)



PENNE GEL A SCATTO

Punta media, tratto 0,7 mm.
Impugnatura antiscivolo.

11846/1x12

12 penne - nero

11846/2x12

12 penne - blu

11846/3x12

12 penne - rosso

11669/1

confezione 2 penne - nero

11669/2

confezione 2 penne - blu



PENNA ROLLER

Ideale per evitare contraffazioni.
L'inchiostro resiste all'acqua,
ai solventi, al sole e non sbiadisce.

C2635

penna roller document
tratto mm.0,7



12730

confezione 8 penne gel glitter
colori assortiti



Evidenziatori

Punta scalpello,
tratto da 1 mm a 5 mm
asciuga rapidamente.

11675/1x10

10 evidenziatori - giallo

11675/2x10

10 evidenziatori - verde

11675/3x10

10 evidenziatori - arancio

11675/4x10

10 evidenziatori - fuxia

1675/5x10

10 evidenziatori - azzurro

11672/1

confezione 2 evidenziatori - giallo

11674

confezione 4 evidenziatori - colori assortiti



Matite grafite

pag.269-271
temperamatite e gomme



cm.18x0,8 ø corpo giallo

C1602/12

scatola 12 matite temperate HB esagonali

C1380/12

scatola 12 matite HB esagonali con gomma

C1602/60

barattolo 60 matite temperate HB esagonali

C1380/60

barattolo 60 matite HB esagonali con gomma



C1602/12

C1602/60

cm.18x0,8 ø corpo giallo

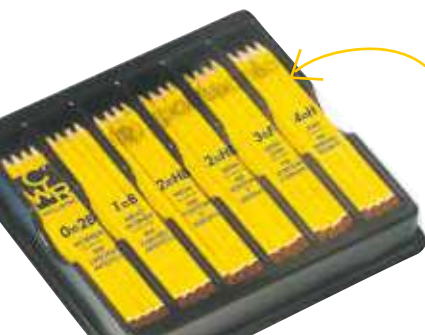

C1770/E

PACK SCUOLA 72 matite

contiene:

2B (12 pz.)

B (12 pz.)

HB (24 pz.)

F (12 pz.)

H (12 pz.)

Scatola 12 matite esagonali

C1770/2B - gradazioni: 2B

C1770/B - gradazioni: B

C1770/F - gradazioni: F

C1770/H - gradazioni: H

C1770/HB - gradazioni: HB



C3423/12

12 matite rosso/blu
esagonale cm.18x0,9 ø



Impugnature

- Un aiuto per imparare a scrivere
- Design ergonomico
- Grip soffice e antiscivolo
- Perfetta anche per mancini

KR971539

set 2 pezzi

KR971540

PACK SCUOLA 48 pezzi



11430

impugnatura per matite
set 10 pezzi



11448

impugnatura triangolare
per matite set 6 pezzi

Portamine

05347

portamine automatico in metallo
con clip per mine mm.0,5
lunghezza cm.13



C5209

portamine con affilamine e clip
metallica per mine ø mm.2
lunghezza cm.14



C5347

portamine per mine e carboncini
fino a ø mm.6 - lunghezza cm.14
con una mina inclusa



SCATOLA 6 MINE MM.120X5,6 Ø
(PER ART. C5347)

C4865/2B - tratto duro

C4865/4B - tratto medio

C4865/6B - tratto morbido



04550

portacarboncini lunghezza cm.17



C4150/2

C4150/1

C4150/3

12 MINE Ø MM.0,5 LUNG. CM.6

C4150/1 - gradazioni: 2B

C4150/2 - gradazioni: B

C4150/3 - gradazioni: HB

C4150/4 - gradazioni: F

C4150/5 - gradazioni: H



CONF. 12 MINE Ø MM.2 LUNG. CM.9

05588 - gradazione 1

05589 - gradazione 2

05590 - gradazione 3



scatola 12 matite TUTTA-MINA

C8911/2B

gradazione 2B

C8911/HB

gradazione HB

Carboncini



04557

scatola 8 carboncini NATURALI

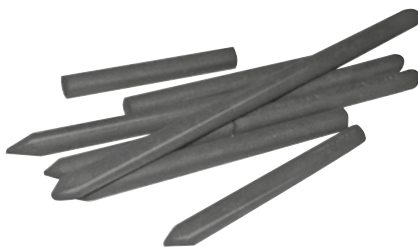

Scatola 6 carboncini ARTIFICIALI
lunghezza cm.12 - ø mm.5,6

K867301 - morbido

K867302 - medio

K867303 - duro



10559

10558

10559

set 3 torciglioni misure assortite

10558

set 6 sfumini misure assortite

Temperamatite

05363
in metallo 1 foro
cm.1,5x2,5x1 h

05364
in metallo 2 fori
cm.2,5x2,5x1,3 h

05362
in plastica 1 foro
cm.1,5x2,5x1 h

W32
in plastica 2 fori
cm.3x3,5x1,5 h



09800
temperamatite in plastica
con serbatoio 2 fori (grande e piccolo)

W12
temperamatite in plastica
a 1 foro con cupola
cm.1,5x3x2,5 h

04493x24
24 temperamatite colori assortiti
con cupola di raccolta ø cm.4

W13x20
20 temperamatite
con cupola di raccolta ø cm.4



- Rivestimento in gomma morbida
- Facile da usare



RIVESTITO
IN GOMMA
MORBIDA



KR970531
temperamatite rivestito
in gomma 2 fori

KR971835
PACK SCUOLA 24 pezzi
rivestiti in gomma 2 fori
colori assortiti

- Per matite ø mm.8
- Coperchio di sicurezza trasparente
- Rivestimento morbido ed ergonomico
- Antiscivolo



KR972116
set 2 pezzi in plastica 1 foro

KR972117
PACK SCUOLA 72 pezzi
in plastica 1 foro colori assortiti

Affilamine



499x12
12 affilamine a 12 fogli

TS501
affilamine da tavolo ø cm.3,5x6 h

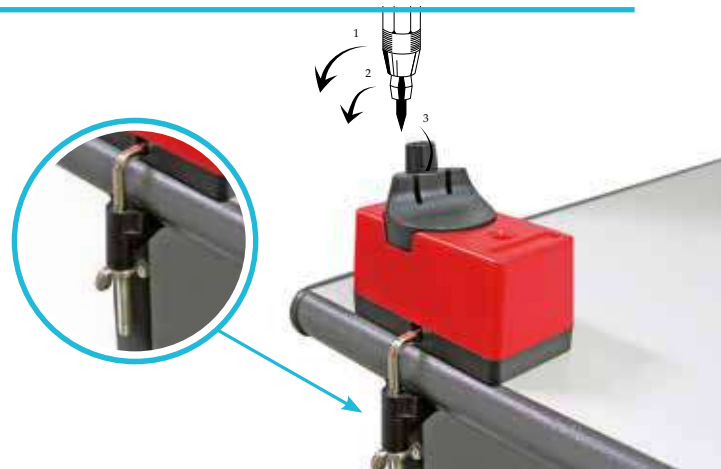

T1140
affilamine da scrivania con morsetto
cm.4,5x9x7,5 h

Temperamatite "Duo Sharpy"



- Per matite \varnothing mm.8 - multifunzione
- Rivestimento morbido
- Per punte affilate o tondeggianti
- Dotato di contenitore per trucioli



KR971605

temperamatite in plastica

KR971606

PACK SCUOLA 18 pezzi
in plastica 1 foro colori assortiti



DUO SHARPY
2 in 1

pag.51
matite colorate

per matite grafite
 per matite colorate

Temperamatite elettrico "Race"

- Per matite \varnothing mm.8
- Funziona con 2 batterie AA (non incluse)
- Design moderno e colori brillanti



KR971783

temperamatite **ELETTRICO**
in plastica 1 foro



ANCHE PER MATITE
TRIANGOLARI



SISTEMA DI SICUREZZA



09353

temperamatite elettrico cm.13x7x8,5 h
funziona con 4 batterie stilo (non incluse)



05384



05385



05306

05384 - temperamatite "dinosauro"

05385 - temperamatite "rana"

05306 - temperamatite "classic"
con contenitore per truciolo e morsetto per fissaggio
cm.5x7x9 h



83102

temperamatite cm.12x19x12 h

Dotato di un meccanismo di regolazione
che permette di ottenere cinque differ-
renti livelli di affilatura della punta.



Gomme per cancellare

12106

gomma piccola per matite IK30
cm.4x2,3x1,3 h

12107

gomma grande per matite IK20
cm.6,5x2,3x1,3 h



K6421x4

4 gomme pane in caucciù SOFT
mm.50x40x10



H6521/40

gomme rosso/blu in caucciù per matita e inchiostro scatola 40 pezzi
mm.57x19x8



D103-6

gomme in caucciù 6 pezzi
mm.50x20x10 colori assortiti

Gomma "RooFix"

- Non contiene PVC
- Colori FLUO



KR971813

set 3 pezzi colori assortiti

KR971814

PACK SCUOLA 24 pezzi colori assortiti

Gomma/cappuccio "Cappy"

- Non contiene PVC
- Gomma per cancellare e cappuccio per proteggere la punta della matita
- Salvamina anti-smarrimento

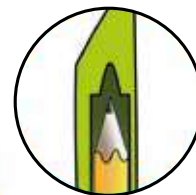

KR970702

set 8 pezzi colori assortiti

KR970999

PACK SCUOLA 72 pezzi
colori assortiti

Correttori



T510

correttore a nastro - nastro: mm.5x8 mt.

09215

2 correttori a nastro - nastro: mm.5x8 mt.



T0801

penna correttore con punta in metallo
contenuto: ml.7



tratto 0,8 mm.

Gommini adesivi rimovibili

Sostengono fogli, disegni, poster ecc.. Possono essere utilizzati in sostituzione del nastro adesivo, spilli, puntine, magneti e colla.

06468

54 gommini adesivi rimovibili
mm.6x9 - totale gr.50



Riposizionabili
Non lasciano residui
Riutilizzabili al 100%
Sicuri e atossici



Spugnette biadesive

Ideali per dare spessore alle realizzazioni con découpage 3D o per appendere piccoli oggetti, fotografie, disegni...



mm.6x1 h



09758

200 fondini biadesivi pretagliati

Velcro adesivo

Sistemi di chiusura pratici e resistenti, con lato autoadesivo che consente una rapida applicazione su svariate superfici.



08196

busta 24 dischetti velcro adesivo mm.19

08197

busta 1 striscia in velcro cm.50x2

Colla scuola



T093

T564A

T093

colla "Matitone" cc.40 con beccuccio stendicolla. Dotata di un temperamatite e di una gomma

T564A

colla "Bowling" cc.70. Con testina stendicolla

Colla universale

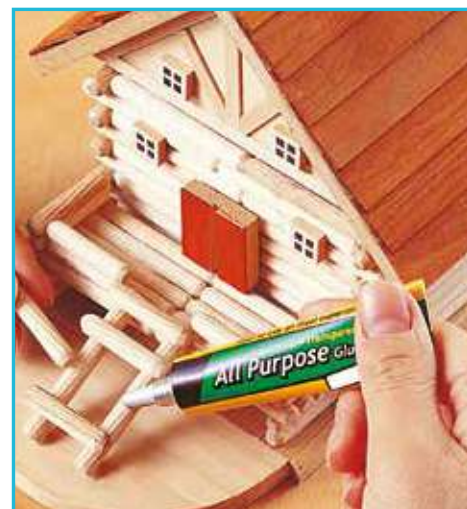

05879

colla ml.30

Adesivo per metallo, vetro, legno, plastica, cartone...

Pistole e colla a caldo

Consentono di incollare oggetti di ogni materiale: cartone, stoffa, ceramica, legno, ferro, plastica, vetro, gomma ecc.



PISTOLA MINI CLASSICA

TG02M

mini pistola con carica automatica
5-20 W (2 stick \varnothing mm.7 inclusi)

STICK

COLLA A CALDO TRASPARENTE

T705M

blister 12 stick \varnothing mm.7
lunghezza cm.10



11749

CONFEZIONE SCUOLA
50 stick \varnothing mm.7
lunghezza cm.10

STICK COLORATI

COLLA A CALDO

12070

blister 12 stick \varnothing mm.7
lunghezza cm.10



STICK GLITTER

COLLA A CALDO

12071

blister 12 stick \varnothing mm.7
lunghezza cm.10



PISTOLA GRANDE CLASSICA

TY102

pistola con carica automatica
7-55 W (2 stick \varnothing mm.11 inclusi)

STICK

COLLA A CALDO TRASPARENTE

T705W

blister 6 stick \varnothing mm.11 lunghezza cm.10

T705A

blister 6 stick \varnothing mm.11 lunghezza cm.20

T705A/1000

CONFEZIONE SCUOLA 1 kg. stick
 \varnothing mm.11 lunghezza cm.20

12829

blister 6 stick **ADESIVO FORTE**
 \varnothing mm.11 lunghezza cm.10

NOVITA'



PISTOLA GRANDE A BASSA TEMPERATURA

06164

pistola con carica automatica per
colle stick a bassa temperatura
7-55 W. Funziona solo con stick
colle per basse temperature.

STICK

COLLA A CALDO TRASPARENTE

06165

blister 6 stick \varnothing mm.11 lunghezza cm.10

06165/1000

CONFEZIONE SCUOLA 1 kg. stick
 \varnothing mm.11 lunghezza cm.10
(per colla art.06164)

La colla a caldo è uno straordinario materiale per fissare e incollare, ma è anche usata per la creazione di svariati oggetti: lavoretti didattici, piccoli gioielli, centrini... È inoltre ideale per realizzare decorazioni a rilievo su molteplici superfici come plastica, gomma, legno, vetro ecc.



Colla stick

Incolla foto, tessuti e ogni tipo di carta senza lasciare nè tracce nè sbavature. Atossica, è adatta per la scuola, la casa e l'ufficio.



ALTA
QUALITÀ
PVP



- 05177 - colla stick gr.10
- 05178 - colla stick gr.21
- 05179 - colla stick gr.40

Colla trasparente

Colla trasparente per carta, cartoncino, collage. Indicata per lavoretti hobbistici e scolastici.

COLLAGE



- 12033
colla gr.60



- 12030
colla gr.250



- 12031
colla Kg.1

Colla trasparente

Colla speciale per

SLIME



- T105
colla ml.50



- 11877
flacone 250 ml. colla trasparente
- 08093
flacone 1000 ml. colla trasparente



- TIPO FORTE
- 09189
flacone 1000 ml. colla trasparente liquida BLU
- 10452
barattolo 5 litri colla trasparente liquida BLU

Kg.5
CONFEZIONE
RISPARMIO

Colla vinilica

Trasparente dopo l'essiccazione, senza solventi, inodore.

20%
PRODOTTO
IN PIÙ!



- 123/100** - colla vinilica gr.120
- 123/250** - colla vinilica gr.250
- 123/500** - colla vinilica gr.500
- 123/1000** - colla vinilica gr.1000
- 12061** - colla kg.3,8
- 07609** - colla kg.5 confezione risparmio
- 07608** - colla kg.1 PLASTIFICAZIONE FORTE
- 07610** - colla 66 kg.1 PLASTIFICAZIONE EXTRA FORTE



- 10240**
15 flaconi ml.80 con tappino antirovescio di sicurezza e tappo con pennello

Colla evident

Colla vinilica di colore azzurro che permette di vedere dove si stende il collante, evitando sbavature o errori.

- **07627**
colla Evident ml.110



Flaconi

Flacone con serbatoio ricaricabile con tempere, acrilici, colori per tessuti, ecc...

- 12317**
confezione 10 flaconi ml.50



Colla

- Colla di colore blu, ben visibile ai bambini, per evitare sbavature
- Ottima aderenza a svariate superfici
- Ideata per bambini, atossica e sicura

- NOVITA'**
KR972339
colla gr.150



Colla spray



T114

bombola ml.400 colla **Spray Permanente**
Adesivo trasparente di facile utilizzo, che permette di incollare qualsiasi tipo di materiale su ogni superficie, porosa o liscia.

T113

bombola ml.400 colla **Spray Rimovibile**
Adesivo trasparente che permette in ogni fase del lavoro di riposizionare gli oggetti incollati e, a lavoro terminato, di incollarli definitivamente.

Colle speciali



- **07622** - barattolo ml.150 colla a freddo pronta all'uso
- **05788** - barattolo ml.150 pasta adesiva BINDER per carta, cartone, stoffa e legatoria
- **05790** - barattolo ml.150 colla Acril
Colla a freddo pronta all'uso, ideale per legno, sughero, carta, stoffa, pelletteria...
- **05786** - barattolo ml.250 colla delicata base acqua per lavori cartotecnica/restauro
- **05787** - barattolo ml.250 colla forte base acqua per carta, legno, sughero
- **06769** barattolo ml.250 MASTICE K3000 adesivo acrilico in dispersione acquosa color ambrato
- **04820** - barattolo ml.250 colla delicata per decoupage con tovaglioli
- **04821** - barattolo ml.250 colla forte per decoupage con carta, cartoncini

Portapistola colla a caldo

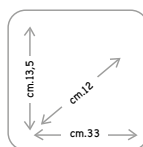

11532

base portapistola colla a caldo
base: cm.33x12x13,5 h
(pistola esclusa)



Nastro adesivo trasparente

Per uso quotidiano, casa, scuola, ufficio.
Ottima adesività, trasparenza e resistenza.
Film di polipropilene. Adesivo acrilico a base acqua.
Confezionati a torretta in film termoretrato.

TORRE MM.15 (10 pezzi)

64/1510
mm.15x10 mt.
64/1533
mm.15x33 mt.
66/1566
mm.15x66 mt.

TORRE MM.19 (8 pezzi)

64/1933
mm.19x33 mt.
66/1966
mm.19x66 mt.



64/1533/BL
mm.15x33 mt.
66/1566/BL
mm.15x66 mt.



78/5066
cm.50x66 mt. trasparente



SCRIVIBILE



80/1933
mm.19x33 mt.
nastro adesivo invisibile
SCRIVIBILE E REMOVIBILE

Nastro di carta - masking

Perfetto per mascherature di ogni genere, su pareti, metallo, gomma, legno, plastica... Indicato per lavori artistici, imballaggi leggeri, rilegature e mascherature. Carta semicrespata. Adesivo in gomma sintetica.

81/1950
mm.19x50 mt.
81/2550
mm.25x50 mt.

81/3850
mm.38x50 mt.
81/5050
mm.50x50 mt.

SI RIMUOVE
SENZA LASCIARE
ALCUNA TRACCIA



Nastro biadesivo trasparente

Nastro biadesivo trasparente ideale per cartotecnica, hobbistica, lavori generici... Adesivo acrilico a base acqua, supporto in polipropilene biorientato.

76/5005

mm.50x5 mt.

76/1250

mm.12x50 mt.

76/1950

mm.19x50 mt.

76/2550

mm.25x50 mt.

76/5050

mm.50x50 mt.



76/1510/BL

nastro biadesivo mm.15x10 mt.

Nastro biadesivo



08319

nastro biadesivo rimovibile
mm.50x50 mt.

Speciale nastro biadesivo per moquettes,
tappeti e passatoie



08315

nastro biadesivo trasparente
mm.15x10 mt



08314

nastro mm.19x25 mt.

Nastro da imballo silenzioso

Per la chiusura di imballaggi in cartone. Resistente alla rottura, all'umidità e all'abrasione. Film di polipropilene. Adesivo acrilico a base acqua.

77/5066

cm.50x66 mt. avana

78/5066

cm.50x66 mt. trasparente



Nastro adesivo colorato

82/5066/1

cm.50x66 mt. - giallo

82/5066/2

cm.50x66 mt. - rosso

82/5066/3

cm.50x66 mt. - verde

82/5066/4

cm.50x66 mt. - blu



Nastro magnetico

Magnetizzare piccoli oggetti non è mai stato così facile!

NOVITA'

12840

nastro magnetico mm. 19x3 METRI



Foglio magnetico

Foglio magnetico autoadesivo. È sufficiente tagliare un pezzo del foglio magnetico autoadesivo, attaccarlo sulla superficie da magnetizzare e il gioco è fatto!

12652

foglio magnetico ADESIVO
cm.10x15 cm. (10 pezzi)



10
PEZZI



STAMPA E APPLICA
L'IMMAGINE SUL FOGLIO
MAGNETICO ADESIVO



TAGLIA IL FOGLIO
MAGNETICO A
PIACIMENTO

Dispenser nastro adesivo



05918

distributore da banco
per nastro adesivo mt.33
dimensioni: cm.6x14,5x7 h
(nastro adesivo escluso)



05978

dispenser da banco per nastro adesivo
mt.33/66 (l'adattatore incluso nella
confezione consente di utilizzare rotoli di
nastro adesivo da mt.33 e 66) dimensioni:
cm.9x21,3x10 h (nastro adesivo escluso)



85

distributore impugnabile
(nastro adesivo escluso)
cm.13x25x6,5 h



E898

dispenser da banco per nastro
adesivo mt.33 (nastro adesivo escluso)
cm.5,5x11,5x4,5 h

E898/4

distributore nastro adesivo
+ 4 rotoli mt.33 - cm.5,5x11,5x4,5 h

DISTRIBUTORE
MULTIUSO
CM.18,5x20

B22

distributore da banco
di nastro decorativo cm.18,5x20x9 h
+ distributore per nastro adesivo mt.66
+ portaoggetti (accessori non inclusi)



Forbici per bambini



775/SF
forbicine centimetrare cm.13
775
OFFERTA SCUOLA
30 forbicine centimetrare cm.13



751/S
forbicine cm.10,5 impugnatura
in plastica - punta tonda
751/S12
OFFERTA SCUOLA 12 forbicine
cm.10,5 impugnatura in plastica
punta tonda



752
busta 12 forbici cm.11



779/1
forbici cm.13,5 punta tonda

- Lame di sicurezza in acciaio, resistenti e durature con punta arrotondata
- Impugnatura ergonomica e confortevole in plastica



KR971833
forbici "Start" cm.13

KR971844
PACK SCUOLA 20 forbici
cm.13 - colori assortiti



KR971505
forbici "Soft Grip" cm.13

KR971532
PACK SCUOLA 20 forbici
cm.13 - colori assortiti



KR971551
forbici "Soft Grip" cm.15

KR971552
PACK SCUOLA 20 forbici
cm.15 - colori assortiti



09885
ceppo portaforbici (18 posti)
base in legno cm.21x10x2,4 h

Forbici per bambini



- Forbici di sicurezza prive di lama
- Punta arrotondata
- Effetti zig-zag (4)
- 4 lame intercambiabili
- Lunghezza cm. 12,7

NOVITA'

KR972337

blister 4 forbici zig-zag cm.12,7



772/S

forbici zig-zag cm.14
punta tonda, lama in plastica



KR971406

PACK SCUOLA 20 forbici
cm.13 - fantasie assortite



12072

forbici centimetrare cm.13,5
con rientro automatico punta tonda

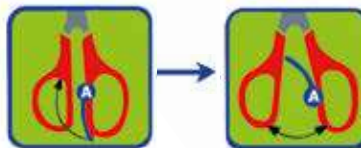

KR972059

forbici "For Kids" cm.13

KR972060

PACK SCUOLA 20 forbici
cm.13 - colori assortiti



- Forbici di sicurezza
prive di lama
- Punta arrotondata



NOVITA'

KR972317

blister forbici cm.12,5

- Forbici di sicurezza
prive di lama
- Punta arrotondata



NOVITA'

KR972334

blister forbici "Animals"
cm.12,5

Forbici decorative IN PLASTICA

FORBICI CM.13,5

777/T1

zig-zag



777/T2

onde



777/T3

deco



777/T4

onde piccole



777/T5

ornamento



FORBICI CM.16

04319

onde



04320

zig-zag

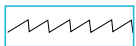

04321

greca



07984

onde larghe



06658

blister forbici cm.17
con 3 lame
intercambiabili

06659

scatola forbici cm.17
con 8 lame intercambiabili

Forbici tagliacampioni / zig zag

Forbici studiate per tagliare stoffe e tessuti senza sfilacciarli. Non adatte ai bambini.



770/S

forbici cm.20 lama in ghisa
impugnatura in materiale acrilico



05613

forbici cm.23 lama in acciaio inox
impugnatura in materiale acrilico

Forbici speciali



762

forbici centimtrate
impugnatura per mancini cm.13



2414

forbici da tavolo con
rientro automatico
cm.11,5



2412

forbici con impugnatura mano destra - cm.16



763

forbici terapeutiche cm.17
centimtrate a presa doppia



Forbici in metallo



759

forbici inox tipo extra punta tonda cm.10,5

05498

forbici inox tipo extra punta tonda cm.12

758

forbici inox tipo extra punta tonda cm.15,5



06027

forbici inox tipo extra per ufficio cm.18

756

forbici inox tipo extra per ufficio cm.20,5

757

forbici inox tipo extra per ufficio cm.23



755

forbici inox tipo extra cm.15,5



05496

forbicine cm.9 punta dritta

04880

forbicine cm.9 punta curva

Forbici lama inox impugnatura in plastica



773

forbici cm.16,5 impugnatura in plastica

767

forbici cm.16,5 punta tonda impugnatura in plastica



T760

forbici cm.21 impugnatura in plastica

06026

forbici cm.25,5 impugnatura in plastica



768

forbici cm.21 impugnatura in plastica



IMPUGNATURA IN GOMMA

07996 - forbici ufficio cm.15

05418 - forbici ufficio cm.18

05419 - forbici ufficio cm.21,5



Cutter e Taglierine



09329
cutter con freno lama 9 mm.
(utilizza lame art. T02)



09330
cutter con freno lama 18 mm.
(utilizza lame art. T05)



09331
cutter con freno lama 9 mm.
anima in metallo + lame di ricambio in blister
(utilizza lame art. T02)



09332
cutter con freno lama 18 mm.
anima in metallo + lame di ricambio in blister
(utilizza lame art. T05)

T02
confezione 10 lame 9 mm. per cutter piccolo

T05
confezione 10 lame 18 mm. per cutter grande



09142
disk cutter cm.58x27,5x6,5 h
con disco rotante formato A3



06882
blister taglierina easy-cut
dimensione area di taglio: cm.30
dimensione totale taglierina: cm.10x37

Roller Cutter

Cutter dotati di una lama che consente di tracciare in modo facile e sicuro tagli dritti o tratteggiati e di cordonare carte e cartoncini.



06885
tratteggio



06886
cordonatura



03578
cutter circolare
lama dritta

03579
cutter circolare
lama effetto "onda"



Perforatori



C644

perforatore doppio con guida passo 8
4 fori \varnothing mm.6 cm.9x28,5x7 h - capacità: 8 fogli



E707

perforatore con guida, passo 8 - 2 fori (\varnothing mm.6)
cm.5,8x11,3x5 - capacità: 10 fogli



05395

perforatore gigante
con guida, passo 8, 2 fori
(\varnothing foro mm.6)
cm.12x16,5x16 h
capacità: 60 fogli



WT228

sparapunti/cucitrice + 200 punti metallici
(utilizza punti art.WTL6-WTL8)
lunghezza punti: mm.4, 6, 8 - spessore punti: mm.0,7
larghezza punti: esterna mm.13, interna mm.10
Dotata di una base asportabile che permette di
trasformarla in cucitrice per alti spessori.
Dotata di meccanismo di disinceppamento automatico.



E9201

E1099

E9201

perforatore a pinza cm.6x12,5 a 1 foro (\varnothing mm.6)
capacità 6 fogli

E1099

perforatore cm.2,5x9,5x3,5 h a 1 foro (\varnothing mm.6)
capacità 8 fogli



05351

perforatore gigante con guida, passo 8
2 fori (\varnothing foro mm.6) capacità: 520 fogli
cm.34x14,5x26,3 h - kg.6,7



RICAMBIO PER PERFORATORE (ART.05351)

06088 - busta 10 dischetti \varnothing cm.3

10303 - punzone in acciaio



WT23

sparapunti + 200 punti metallici
(utilizza punti art. WTL6-WTL8)
lunghezza punti: mm.4, 6, 8 - spessore punti: mm.0,7
larghezza punti: esterna mm.13, interna mm.10

WTL6 - scatola 1000 punti mm.6

WTL8 - scatola 1000 punti mm.8

Cucitrici



E1013

MP15

E1013

cucitrice in metallo e abs cm.2x9,5x4 h - capacità 10 fogli
profondità cucitura cm.4,5 + scatola 500 punti n°10

MP15

mini cucitrice a pinza in metallo cm.5,5x11x2 h
capacità 12 fogli profondità cucitura cm.2,7
(utilizza punto n°10)



E828

cucitrice a pinza cromata
cm.16x6,5 h (utilizza punti n° 10)

12690

scatola 1000 punti metallici n° 10

12688

scatola 2000 punti metallici n° 10



12124/1

cucitrice a pinza in metallo cm.16x8 h (capacità 12 fogli)
profondità cucitura cm.4,5
(utilizza punto n°6/4)



12693

cucitrice a pinza in metallo (capacità 30 fogli)
profondità cucitura cm.5,5
(utilizza punto n°24/6, 24/8, 26/6)

12689

scatola 1000 punti metallici n°6/4

12687

scatola 2000 punti metallici n°6/4



12691

scatola 1000 punti metallici
n°24/6



05093

cucitrice pesante cm.6,7x28x16 h
punti n° 23/6, 23/8, 23/10, 23/13

C417

cucitrice a braccio lungo
cm.4,5x36,8x7 h
punti n° 24/6, 26/6



MP16

E1030

MP16

levapunti a pinza in metallo cromato
Lunghezza cm.12,5

E1030

levapunti con impugnatura in plastica
cm.5x4,5 h

Basi da taglio



Struttura basi da taglio

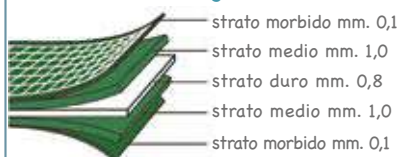

TCM016 - cm.30x22

TCM008 - cm.45x30

TCM004 - cm.60x45

TCM002 - cm.60x90



T200

confezione in blister: 1 base da taglio cm.21 x 29, 1 penna cutter a mandrino, 2 lame (totale 20 punte), 1 attrezzo di sicurezza per sezionare le lame

Basi da taglio

Base da taglio in legno di betulla.
Bordi arrotondati, spessore mm. 18



08015 - cm.15x24

08016 - cm.20x29

Piano in lattice

Base soffice e morbida in vero lattice.
Ideale per lavori di sbalzo, punzecchio.



07126 - cm.21x29,7

07128 - cm.15x20

Portacorrispondenza

Sovrapponibili in linea e lateralmente, impilabili a incastro. Per riordinare molta corrispondenza é stato studiato il distanziatore che consente di sovrapporre i portacorrispondenza lasciando molto spazio utilizzabile tra uno e l'altro.

PORTACORRISPONDENZA
CM.27,5x34x7

2S/1 ● Nero

2S/2 ● Rosso

2S/3 ● Blu

2S/ASSx20

20 portacorrispondenza
colori assortiti

2S/V4x6

6 set da 4 distanziatori
(per art.2S/1, 2S/2, 2S/3)

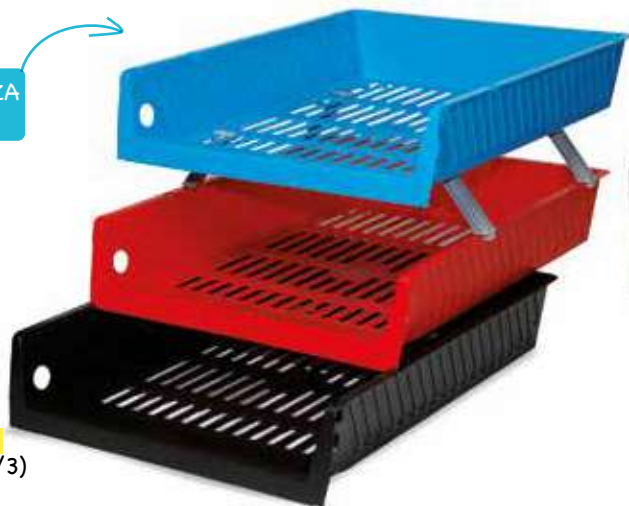

PORTARIVISTE CM.7,5x24,5x32 H

2PK/1 ● Nero

2PK/2 ● Rosso

2PK/3 ● Blu

2PK/ASSx12

12 portariviste colori assortiti



PORTAMATITE ø CM.7x9 H

70/BL ● Blu

70/NE ● Nero

70/RO ● Rosso

70/ASSx6

6 portamatite colori assortiti

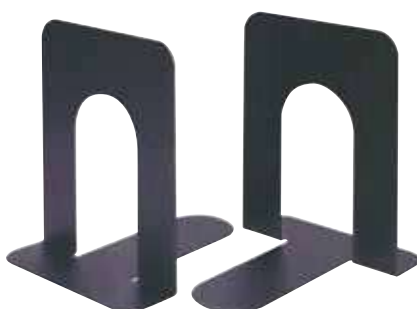

COPPIA REGGILIBRI IN METALLO

05346

cm.12x15x14 h



COPPIA REGGILIBRI CM.10x15x18 H

75/NE ● Nero

Portaoggetti

Contenitori portaoggetti da scrivania e da cassetto. Accessori non inclusi.

74/R

vaschetta portaoggetti
cm.26x28x4 h



Portamatite e foglietti



PORTAMATITE CM.9x11,5x9 H

- 73/BL** ● Blu
73/NE ● Nero
73/RO ● Rosso

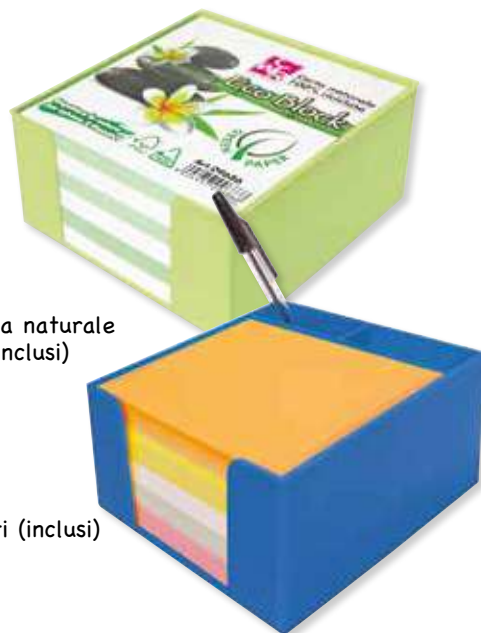

09686
 cm.10x10x5 h
 con fogli di carta naturale
 100% riciclata (inclusi)

1086
 cm.10x10x6,5 h
 con fogli colorati (inclusi)
 e portapenna

Notes adesivi riposizionabili

Scrivi, rimuovi e applica!

- Per evidenziare i tuoi messaggi
- Super adesivi, si attaccano a tutto!
- Riposizionabili



11741
 1 blocchetto 320 fg.
 mm.75x75 giallo

11742
 1 blocchetto 320 fg.
 mm.75x75 neon



11738
 1 blocchetto 100 fg. mm.75x75 giallo

11739
 1 blocchetto 100 fg. mm.75x100 giallo

11740
 1 blocchetto 100 fg. mm.75x125 giallo

11737
 set 3 blocchetti 100 fg./cad
 mm.40x50 - giallo



11728
 segnapagina adesivi in plastica 25 fogli
 mm.12x45 (5 blocchetti colori assortiti)

11729
 segnapagina adesivi in plastica 35 fogli
 mm.12x45 (4 blocchetti colori assortiti)

Segnapagina in carta, adesivi e scrivibili.
 Scrivi, rimuovi e applica!
 • Indicati per cataloghi, libri e documenti
 • Resistenti e riposizionabili



Cubi di carta

FOGLIETTI BIANCHI MM.95x95

11724 - 700 fogli bianco

FOGLIETTI COLORATI MM.95x95

11725 - 740 fogli pastello

11726 - 720 fogli bianco/neon

11727 - 740 fogli arcobaleno

Timbrini dei giudizi preinchiostrati

Ideali per insegnanti e genitori, questi timbrini preinchiostrati consentono di valutare l'operato degli studenti utilizzando 4 espressioni facciali molto eloquenti e colorate. Un modo pratico e divertente per esprimere il proprio giudizio senza essere troppo severi!

Autoinchiostranti
4 espressioni facciali
4 colori di inchiostro
Lunga durata
Stampa mm.20



NOVITA'

12655

set 4 timbrini dei giudizi preinchiostrati
(diametro stampa mm.20 circa)

Timbri



T72

timbro polinomi 12 frasi
cm.8x8 h

- 1 URGENTE
- 2 RACCOMANDATA
- 3 ESPRESSO
- 4 VIA AEREA
- 5 STAMPE
- 6 FATT. COMM. APERTA
- 7 MANOSCRITTI
- 8 PAGATO
- 9 COPIA
- 10 ANNULLATO
- 11 NON TRASFERIBILE
- 12 REGISTRATO



05340

numeratore a 6 cifre, mm.4

05341

numeratore a 7 cifre, mm.5

T28

numeratore a 8 cifre, mm.4

T48

numeratore a 6 cifre, mm.4

T868

portatimbrini 6 posti girevole
in metallo ø cm.10x8 h

T8416

portatimbrini 16 posti girevole
in metallo ø cm.14x17 h



T868

T8416

CUSCINETTO INCHIOSTRATO
CM.8,5x12

- 05336** ● Blu
- 05337** ● Nero
- 05338** ● Rosso



FELTRO ALTA DENSITA'

1581/2

cm.15x20 spessore 8 mm.

1581/3

cm.20x30 spessore 8 mm.



BAGNADITA Ø CM.8

13/9

spugna tipo mare

13/8

spugna in gomma

BAGNADITA Ø CM.10

13/10

spugna tipo mare

13/11

spugna in gomma

T7420

tagliacarte cm.23
in acciaio inox



Lenti d'ingrandimento

Consentono di ottenere un ingrandimento molto potente.
Lente in vetro, ghiera in metallo e impugnatura in materiale acrilico.



05355 - lente \varnothing cm.5 (zoom 5X)

05356 - lente \varnothing cm.7,5 (zoom 3X)

05614 - lente \varnothing cm.10 (zoom 2X)



12014

lente ingrandimento bifocale \varnothing cm.7,5
con luce led (zoom 3x lente grande/ 6x lente piccola)



classificatore "POLARIS" per francobolli
cm.17x23

● **950/2** - 8 fogli bianchi

● **950/3** - 10 fogli bianchi

950/4 - 12 fogli bianchi

Portabadge



05972x50

50 portabadge con spilla e clip - cm.6x9



05973x50

50 portabadge con clip - cm.6x9



05974x100

100 portabadge con cordoncino - cm.7x11



05977x25

25 targhette portachiavi con anello
cm.2,5x6,5 colori assortiti



TARGHETTE CON ANELLO OGIVALE

M955/6x6

6 targhette colori assortiti

M955x100

100 targhette colori assortiti



Cassette portavalori in metallo
con scomparto interno in plastica
antiurto e cilindretto di sicurezza
con 2 chiavi

05389

cm.12,5x15x7 h (4 scomparti)

05388

cm.15,7x20,5x7,4 h (5 scomparti)

05387

cm.19x26x8 h (5 scomparti)

05386

cm.21x30x10 h (5 scomparti)

Elastici



61/100

busta gr.100 misure e colori assortiti

63

busta kg.1 misure e colori assortiti



65/100

barattolo gr.100
misure e colori assortiti



60

matassina elastici in gomma
5 diametri differenti

BUSTA 1 KG

61/2 - ø mm.30

61/4 - ø mm.50

61/6 - ø mm.75

61/8 - ø mm.100

61/9 - ø mm.120



Elastici fettuccia

BUSTA 1 KG - MM.8 H

62/2 - ø mm.50

62/5 - ø mm.120

62/6 - ø mm.150

Elastici in caucciù



11586

scatola gr.500 elastici in caucciù
misure assortite



68/2

busta 1 kg. ø mm.30

Distruggidocumenti



09148

distruggidocumenti
automatico piccolo
cm.26,5x31,5x13,5



11895

distruggidocumenti automatico
per carta, CD, carte di credito
cm.16,5x28x33



11896

distruggidocumenti automatico
per carta, CD, carte di credito
cm.35x21,5x45

| caratteristiche: | 09148 | 11895 | 11896 |
|--|---------------------|--------------------------------------|---|
| • tipo di taglio | carta: strisce mm.6 | carta: strisce mm.7 - CD/CC: 4 pezzi | carta: "cross" mm.4x18 - CD/CC: 3 pezzi |
| • capacità di distruzione | 6 fogli A4 80 gr. | 7 fogli A4 80 gr./ 1 CD | 8 fogli A4 80 gr./ 1 CD |
| • capacità cestino principale | 7 litri | 13 litri | 21 litri |
| • taglio e raccolta separati carta, CD | - | sì | sì |
| • dimensioni | cm. 26,5x31,5x13,5 | cm. 16,5x28x33 | cm.35x21,5x45 |
| • peso | kg.1,45 | kg.2,2 | kg.3,45 |
| • autostart/stop | no | sì | sì |

Molle fermacarte

MOLLA MAGNETICA FERMACARTE

T0214

clip magnetica in metallo ø cm.3



MOLLA FERMACARTE CROMATA

T402/2x144 - 144 molle cm.2

T402/3x144 - 144 molle cm.3

T402/4x12 - 12 molle cm.4

T402/5x12 - 12 molle cm.5



MOLLA FERMACARTE DOPPIA

T403/2x144 - 144 molle cm.2

T403/2.5x12 - 12 molle cm.2,5

T403/3x12 - 12 molle cm.3

T403/4x12 - 12 molle cm.4



5245/B

confezione 6 molle doppie mm.32
colori assortiti



12

confezione 12 mollettine fermafogli
colori assortiti



CK/90

scatola 8 fermagli freccia
colori assortiti

T1211

assortimento clips
per ufficio



FERMACAMPIONI 100 PZ.

C440/16 - mm.16

C440/20 - mm.20

C440/25 - mm.25

C440/31 - mm.31

C440/40 - mm.40

C440/50 - mm.50

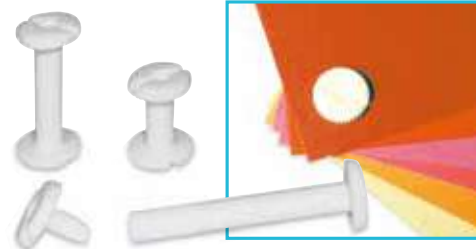

BUSTA 20 VITI SEPOLTE Ø MM.5

06300 - mm.5

06301 - mm.10

06302 - mm.20

06303 - mm.30

06304 - mm.40

Fermagli



11233

C461/1



1202



05366

SCATOLA 100 FERMAGLI IN ACCIAIO

C461/1 - n°1 mm.20

C461/2 - n°2 mm.26

C461/3 - n°3 mm.28

C461/4 - n°4 mm.32

C461/5 - n°5 mm.49

C461/6 - n°6 mm.58

C461/7

scatola 40 fermagli ottonati mm.75

11233

barattolo 240 fermagli in nickel
misure mm.28/32/49/58

E803

portafermagli cm.9x5,5 (fermagli inclusi)

1220

portafermagli calamitato cm.6x7 h
contiene fino a 500 fermagli standard
(non inclusi)



E803



1220

SCATOLINA FERMAGLI "DIANA"

1202

scatolina 100 fermagli "Diana" mm.28 in metallo
rivestito in PVC - colori assortiti

05366

scatolina 50 fermagli "Diana" mm.50 in metallo
rivestito in PVC - colori assortiti

11884

barattolo 200 fermagli misure mm.28 e 32
colori assortiti

Spilli



04907

scatola 56 spille da balia mm.22

04908

scatola 48 spille da balia mm.27

04909

scatola 36 spille da balia mm.32



04344

spilli in acciaio con testa colorata
scatola pz.100 mm.32

04341

spilli per sarti in acciaio
scatola gr.25 mm.32



04342

spilli in ferro scatola gr.250 mm.30

04343

spilli scatola gr.25 mm.14

PUNTINE TONDE - Scatola 70 pezzi

conf./monocolore

- MP331/1** ○ Bianco
- MP331/2** ● Rosso
- MP331/3** ● Blu
- MP331/4** ● Giallo
- MP331/5** ● Arancio
- MP331/6** ● Verde
- MP331/7** ● Marrone
- MP331/8** ● Nero



NOVITA'

MP331/A

scatola 100 pz.
(20 scatolette unicolore assortite
in diversi colori nella confezione)

MP331/M

scatola 100 pz. - colori assortiti nella scatoletta

98/MP331/M

scatola appendibile 100 pz. - colori assortiti nella scatoletta



05169

conf. 16 puntine fantasia
soggetti assortiti



C213

scatola 100 puntine in acciaio n°2

C214

scatola 100 puntine in acciaio n°3

MP900

scatola 100 puntine in acciaio
a 3 punte



1230

scatola da 100 puntine colori assortiti
Per bacheche in sughero.

Calcolatrici



11899

calcolatrice scientifica cm.14,2x7,5x1,5
Grande display da 10 cifre
(2 esponenti, 136 funzioni scientifiche)
Coperchio protettivo incluso. Batterie incluse



Calcolatrice a 8 cifre cm.11x7x2
Doppia alimentazione:
solare e a batteria

11900 - colore grigio

11901 - colore verde



Calcolatrice a 10 cifre cm.14x10x3
Doppia alimentazione:
solare e a batteria

11902 - colore grigio

11903 - colore verde

Batterie e caricabatterie

12153

batteria energy alcaline mini stilo
(blister 4 pezzi)



12153

12154

batteria energy alcaline stilo
(blister 4 pezzi)



12154

12155

batteria energy alcaline
mezza torcia (blister 2 pezzi)



12155

12156

batteria energy alcaline torcia
(blister 2 pezzi)



12156

12157

batteria energy alcaline transistor
(blister 1 pezzo)



12157

12158

batteria litio pastiglia
(blister 2 pezzi)



12158

12159

batteria stilo eco ricaricabile
(blister 4 pezzi)



12159

12160

caricabatterie + 4 pile stilo
eco ricaricabili



12160

Plastificatrici



PLASTIFICATRICI A CALDO

11897

plastificatrice A4 a 2 rulli per foto
documenti, presentazioni.
Per film di spessore da 80 a 125 micron
cm.13,5x35,5x6 - kg. 0,9

11898

plastificatrice A3 a 2 rulli per foto
documenti, presentazioni.
Per film di spessore da 80 a 125 micron
cm.16,5x45,5x6 - kg. 1,35

BUSTE PER PLASTIFICATRICI

Questo prodotto viene utilizzato per
carte d'identità, patenti di guida, licen-
ze, presentazioni, schede tecniche, foto,
diplomi, biglietti da visita, ecc.
Spessore 80 my - Finitura lucida

11905 - 100 fogli A4

11906 - 100 fogli A3



ARIA COMPRESSA

Utilizzabile per rimuovere la pol-
vere da computer, stampanti e da
qualsiasi punto particolarmente
difficile da raggiungere.

613

bombola ml.400
aria ad alta pressione

Cestini per rifiuti

05514

maxi cestino con coperchio basculante ø cm.30x52 h capacità: lt.22



cestino lt.14
finitura tipo pelle
cm.32 h ø inferiore cm.21
ø superiore cm.29

- 9/1 ● Nero
- 9/2 ● Rosso
- 9/4 ● Blu

9/ASSx14

14 cestini gettacarta assortiti



05515

maxi cestino con coperchio basculante
ø cm.40x75 h - capacità: lt.50



05509

bidone con coperchio basculante
ø cm.55x92 h - capacità: lt.100



06169

trespolo forato ø cm.50x85,5 h

06828x25

25 sacchi neri per rifiuti 27 micron
cm.50x60 h capacità lt.25 nero

11931/2

10 sacchi per rifiuti cm.70x110 - giallo

11931/3

10 sacchi per rifiuti cm.70x110 - bianco

11931/4

10 sacchi per rifiuti cm.70x110 - viola



Sacca zainetto in nylon

Sacca zaino in resistente nylon con cordoncini a chiusura dai mille usi, per attività dedite allo sport e per tantissime altre occasioni.

SACCA Zainetto cm.34 x 44

12560/1 - giallo

12560/2 - rosso

12560/3 - verde

12560/4 - blu

12560/5 - grigio



Registro per la scuola

11471

registro scuola dell'infanzia (verde)
per alunni, cucito con punti metallici
cm.24x33,5 (40 pagine)



11472

registro scuola dell'infanzia (rosso)
per alunni, cucito con punti metallici
cm.24x33,5 (52 pagine)



12510

registro dell'insegnante (blu)
per insegnanti, cucito con punti metallici
cm.24x33,5

Set rilegatura



1187/100

1180/100

100 FILM TRASPARENTI CM.21x29,7 (A4)

1180/100

per scrittura manuale e retroproiezioni

1187/100

fotocopiable e per stampanti laser
per retroproiezioni



BUSTE A FORATURA UNIVERSALE
IN POLIPROPILENE TRASPARENTE

09133

100 cartelle cm.22x30 (A4)
spes. 50 micron

09134

50 cartelle cm.22x30 (A4)
spes. 70 micron

● **09136**

25 cartelle cm.22x30 (A4)
spes. 140 micron



CARTELLE PORTADOCUMENTI A "L"
IN POLIPROPILENE TRASPARENTE

09150

50 cartelle cm.22x31 (A4)
spes. 75 micron

09151

50 cartelle cm.22x31 (A4)
spes. 110 micron

09152

25 cartelle cm.22x31 (A4)
spes. 140 micron

Set rilegatura

QUADRANTI IN PVC TRASPARENTE

08460

100 film trasparente
cm.21x29,7 (A4) 150 MY
Film in materiale plastico trasparente indicato per rilegare depliant, cataloghi, presentazioni, listini, ricerche, brochures...



09132x4

4 set rilegatura: 5 copertine fronte/retro in PVC trasparente cm.21x29,7 (A4) + 5 dorsini legafogli cm.29,7 colorati

55/10

set 10 film + 10 cartoncini formato cm.21x29,7 (A4) + 10 dorsini legafogli cm.29,7

Dorsini legafogli

Un modo semplice per trattenere e raggruppare i fogli. Ideali per l'ufficio (rapporti, cataloghi, listini, ecc.), la scuola (progetti, tesi, ecc...), la casa (ricette, garanzie, lettere, ecc...). Passando una corda attraverso il dorso legafogli diviene inoltre possibile appendere calendari, disegni, notizie, carte, ecc...



BUSTA 8 DORSINI CM.29,7

50/8B Bianco

50/8N Nero

50/8/ASS - colori assortiti

DORSINI CONFEZIONATI IN PRATICA SCATOLA



DORSINO A GOCCIA (cartella colori)

09124/...

80 legafogli cm.29,7 - mm.4
capacità 20 fogli

50/...

50 legafogli cm.29,7 - mm.8
capacità 50 fogli

DORSINO TRIANGOLARE (cartella colori)

53/06/...













80 legafogli cm.29,7 - mm.6 capacità 30 fogli

53/10/...

30 legafogli cm.29,7 - mm.10 capacità 60 fogli

53/15/...

25 legafogli cm.29,7 - mm.15 capacità 100 fogli

| colori | GOCCIA mm.4 capacità 20 fg.  | GOCCIA mm.8 capacità 50 fg.  | TRIANGOLARE mm.6 capacità 30 fg.  | TRIANGOLARE mm.10 capacità 60 fg.  | TRIANGOLARE mm.15 capacità 100 fg.  |
|---|---|---|--|---|--|
|  | - | 50/1x50  | - | - | - |
|  | - | 50/2x50 | - | - | - |
|  | 09124/3x80 | 50/3x50 | 53/06/3x80 | 53/10/3x30 | 53/15/3x25 |
|  | 09124/4x80 | 50/4x50 | 53/06/4x80 | 53/10/4x30 | 53/15/4x25 |
|  | 09124/5x80 | 50/5x50 | 53/06/5x80 | 53/10/5x30 | 53/15/5x25 |
|  | 09124/6x80 | 50/6x50 | 53/06/6x80 | 53/10/6x30 | 53/15/6x25 |

*Le misure indicate si riferiscono al formato esterno dei dorsini

Coprilibri



COPRILIBRI UNIVERSALI CM.30x50
MUNITI DI BIADESIVO MM.8/12 PER IL FISSAGGIO

- **5001** - satinato gr.200 neutro
- 5001/ASS** - satinato gr.200 colori ass.



COPRI MAXI CON ALETTE SALVA-ANGOLI CM.30,5x43
IN PVC GOFRATO VETRO - SPESSORE 150 MICRON

- 06125**
copertina copri maxi colori assortiti (nella conf. da 25 pz)



FILM LEGGERMENTE GOFRATO E ANTIRIFLESSO
SPESSORE 72 MICRON

- 06141** - rotolo coprilibri cm.45x5 mt.
colori assortiti (nella conf. da 50 rotoli)
- **06142** - rotolo coprilibri cm.45x5 mt.
colore trasparente neutro



FILM ADESIVO
TRASPARENTE

Per la plastificazione di
piccole superfici, libri,
quaderni, mensole...

- 823**
rotolo cm.45x1,5 mt.
- 823/5**
rotolo cm.45x5 mt.
- 823/10**
rotolo cm.45x10 mt.



Con clip in metallo e bordo centimetrato.

- 03589**
memo board cm.23x32
- **03782**
memo board cm.15x20

Carta per lucidi

10 FOGLI CARTA GR.85/90

- 1060/10** - cm.21x29,7
- 1062/10** - cm.24x33
- 1065/10** - cm.29,7x42
- 1064/10** - cm.33x45

50 FOGLI CARTA GR.85/90

- 1060/50** - cm.21x29,7
- 1062/50** - cm.24x33
- 1065/50** - cm.29,7x42
- 1064/50** - cm.33x45
- 10697** - cm.50x70

CARTA PER LUCIDI SQUADRATA GR.85/90

- 1070/10**
blocco fg.10 cm.24x33
- 1070/50**
blocco fg.50 cm.24x33



Rilegatura con risvolto che evita lo staccarsi accidentale dei fogli.



CARTA PER LUCIDI MILLIMETRATA GR.85/90

- 1063/10**
blocco fg.10
cm.24x33



Carta lucida



ROTELI CARTA MT.20 GR.85/90

- 1074/36** - altezza cm.36

RISME 200 FOGLI CARTA GR.85/90

- 1060/200** - cm.21x29,7
- 1063/200** - cm.29,7x42

Carta millimetrata



10 FOGLI CARTA GR.70

- 1040** - cm.21x29,7
- 1041** - cm.23x33
- 1050/10** - cm.29,7x42

50 FOGLI CARTA GR.70

- 1045** - cm.21x29,7
- 1046** - cm.23x33
- 1050** - cm.29,7x42
- 10696** - cm.50x70

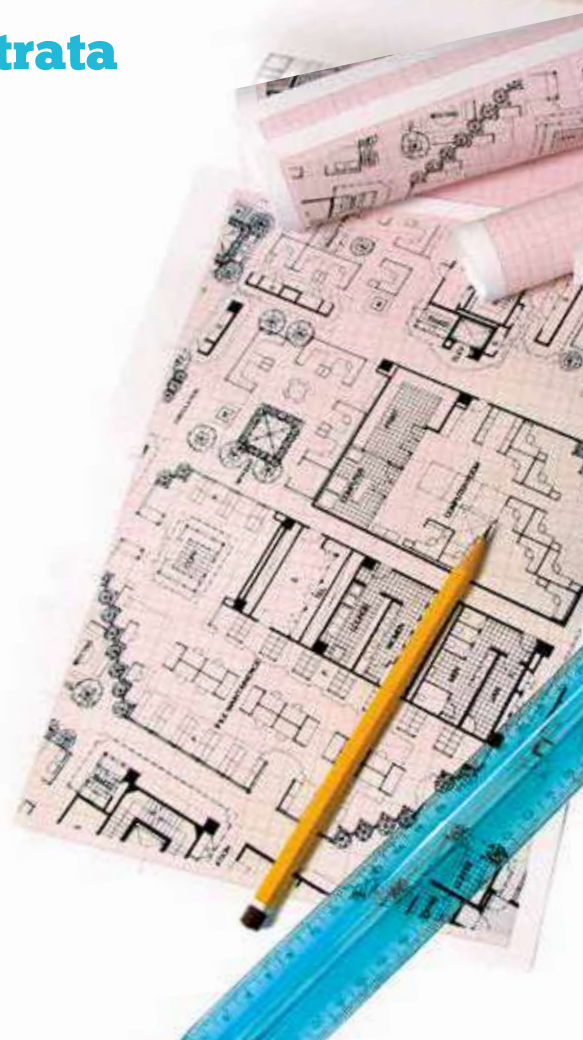

Retini adesivi

I retini TEKNITAK sono fogli acetati colorati, trasparenti e autoadesivi che permettono di realizzare sfondi o disegni colorati. Perfetti per una rapida realizzazione di grafici, diagrammi, bozzetti, esecutivi, ma anche per disegni tecnici ed artistici. L'adesivo a bassa presa che li contraddistingue ne consente il riposizionamento.



790/...

busta 10 fogli opachi unicolore gr.100
cm.21x29,7 (A4)



Portaposter



PORTAPOSTER SFUSO (VEDI CARTELLA COLORI)

51/... - cm.70 con appendino

52/... - cm.100 con appendino

| colori | PORTAPOSTER cm.70 con appendino | PORTAPOSTER cm.100 con appendino |
|--------|---------------------------------------|--|
| Bianco | | 52/G |
| Giallo | 51/A | 52/A |
| Rosso | 51/R | 52/R |
| Blu | 51/B | 52/B |
| Verde | 51/V | 52/V |
| Nero | --- | 52/N |
| Grigio | --- | 52/GR |



54

busta 50 gancini
per portaposter



BUSTA 2 PORTAPOSTER CON APPENDINI

51/2B - cm.70 bianchi

51/2N - cm.70 neri

52/2B - cm.100 bianchi

52/2N - cm.100 neri

Compassi

- Braccia in metallo con vite di bloccaggio
- Adattatore per mine, matite ecc.
- Nel set sono incluse una matita di grafite e una confezione di mine
- Scatola in plastica con righello e stencil per piccoli cerchi



Accessori facilmente intercambiabili

KR971845

PACK SCUOLA 10 astucci compasso "Circle Master" in alluminio



Sistema di bloccaggio



Punta di sicurezza



- Colori vivaci e brillanti
- Impugnatura comoda e antiscivolo
- Design ergonomico
- Punta arrotondata di sicurezza



KR971533

compasso "Flow" in plastica



- Resistente e duraturo
- Materiali di prima qualità
- Design ergonomico
- Utilizzabile anche con matite



KR971442

PACK SCUOLA 10 astucci compasso "Smart" in metallo



05981

compasso in plastica con portamine cm.15 h



C41010

compasso in metallo completo di accessori



C9407

compasso tecnico in metallo completo di accessori



C9401

compasso professionale "balastrone" in metallo completo di accessori

Turbopannello GRAPHIC-BOARD

Pannello composto da un nucleo di schiuma rigida di espanso, rivestito di cartone sui due lati. Ideale per presentazione di bozzetti, scenari, progettazioni, insegne...

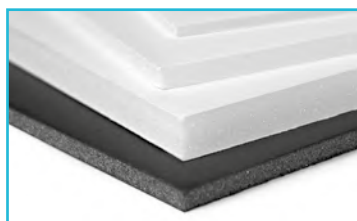

727/2

cm.50x70 spess. mm.5 - bianco

727/3

cm.70x100 spess. mm.5 - bianco

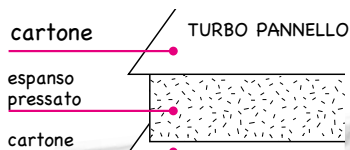

Espanso in lastra

Materiale leggero, si taglia con forbici, cutter, termotrafo.

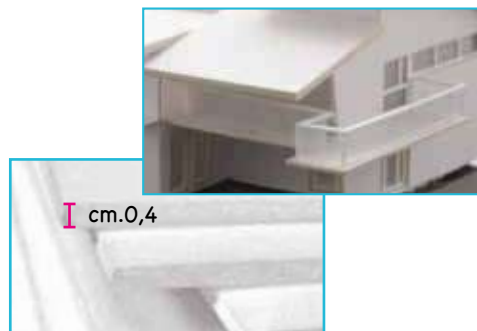

I cm.0,4

1314x10

10 lastre di espanso pressato

ALTA DENSITA'
cm.30x40x0,4 h

Carta plotter

Carta naturale per plotter e stampanti laser, a rapida asciugatura. Ottimo punto di bianco è perfetta per la stampa di bozze e disegni tecnici su plotter ink-jet.

ROTOLO CARTA OPACA GR.90

08653

altezza mt.0,914x45

● **08654**

altezza mt.1,067x45

ROTOLO CARTA OPACA GR.90

07976

altezza mt.0,420x50

07977

altezza mt.0,610x50

07980

altezza mt.0,625x50

07978

altezza mt.0,914x50

07979

altezza mt.1,067x50



Tubi portadisegni



PER FOGLI DA CM.45 A CM.80

09960

tubo ø cm.6,5 nero (in plastica)

PER FOGLI DA CM.65 A CM.105

842T/100

tubo ø cm.10,5 nero (in plastica)

844x6

6 tracolle per tubi telescopici (per.09960 e 842T/100)



TUBI IN CARTONE Ø CM.6

841/50x24

24 tubi cm.54

841/70x18

18 tubi cm.74

TUBI IN PLASTICA Ø CM.6

840/40 - cm.40

840/50 - cm.50

● **840/60** - cm.60

840/70 - cm.70

840/100 - cm.100



Set disegno

KR971247

set disegno contiene:
 1 righello cm.20
 1 goniometro 180°
 1 squadra 15/45°
 1 squadra 15/60°

KR971429

set disegno contiene:
 1 righello cm.30
 1 goniometro 180°
 1 squadra 20/45°
 1 squadra 20/60°



Set disegno flessibili

- Materiale flessibile e resistente agli urti
- Trasparente e sicuro

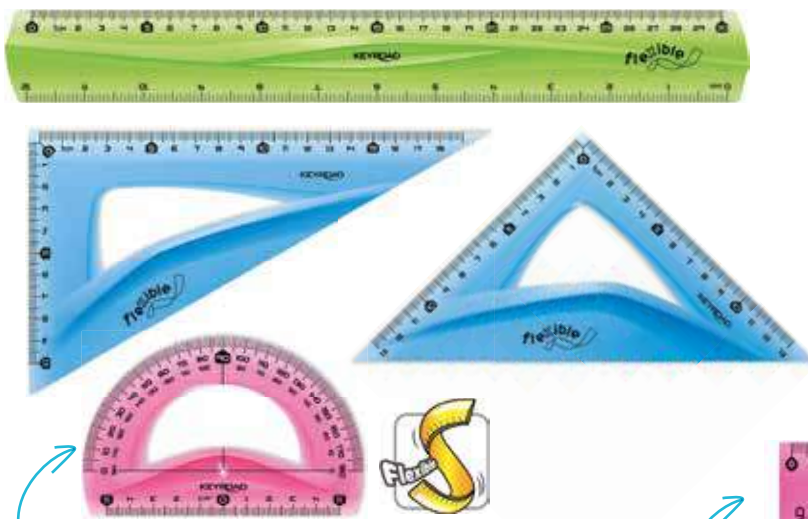

KR970854
 righello cm.30

KR971105

set disegno contiene:
 1 righello cm.30
 1 goniometro 180°
 1 squadra 20/45°
 1 squadra 20/60°



KR970858

set disegno contiene:
 1 righello cm.20
 1 goniometro 180°
 1 squadra 15/60°
 colori assortiti



KR971236

righello rivestito in gomma cm.30



KR971313

righello in alluminio cm.30

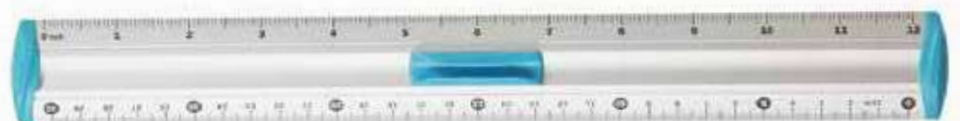

Squadre antiluce

MATERIALE: dall'eccezionale brillantezza e resistenza all'usura

MILLIMETRATURA: di alta precisione

SMUSSO: china interno ed esterno

COLORE: azzurro antiluce che attenua notevolmente il riverbero

INTERNO: spigoli vivi, consente 2 soluzioni d'uso

CONFEZIONE: busta in PVC trasparente con cartoncino stampato

581

set disegno contiene:
1 riga cm.30,
1 squadra cm.25/45°,
1 squadra cm.25/60°,
1 goniometro cm.10/180°

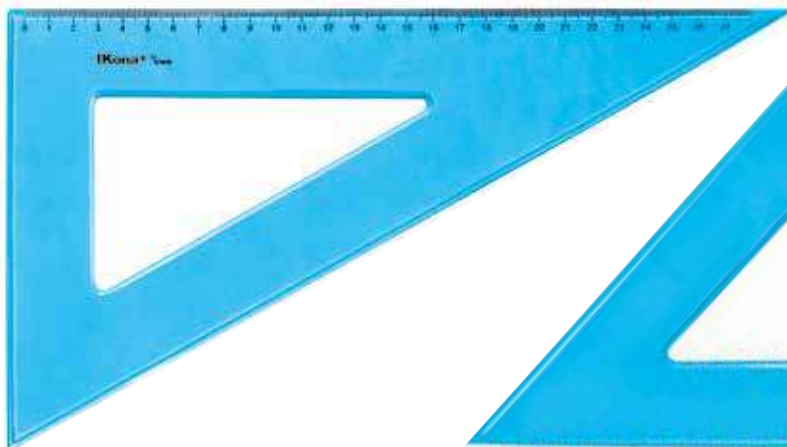

SQUADRA ANTILUCE 45°

- 560** - cm.16/45°
- 562** - cm.20/45°
- 564** - cm.25/45°
- 566** - cm.30/45°
- 568** - cm.35/45°



SQUADRA ANTILUCE 60°

- 561** - cm.16/60°
- 563** - cm.20/60°
- 565** - cm.25/60°
- 567** - cm.30/60°
- 569** - cm.35/60°

COPPIA DI SQUADRE ANTILUCE

- 584/25**
set 1 squadra cm.25/45° + 1 squadra cm.25/60°
- 584/30**
set 1 squadra cm.30/45° + 1 squadra cm.30/60°
- 584/35**
set 1 squadra cm.35/45° + 1 squadra cm.35/60°

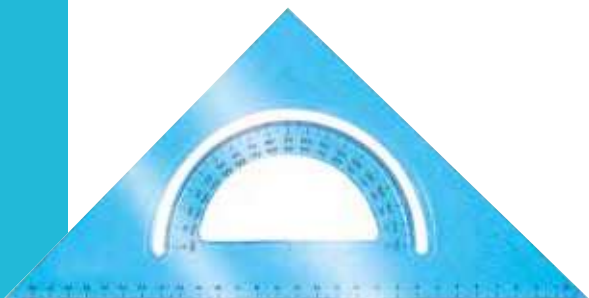

585
squadra antiluce cm.30/45°
con goniometro cm.12,5/180° incorporato



550
goniometro semicircolare cm.12/180°
550/1
goniometro semicircolare cm.15/180°



551
goniometro circolare cm.12/360°

Curvilinee

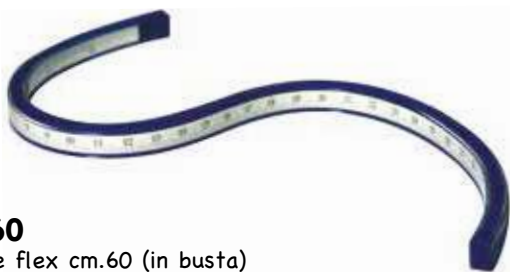

C577/60
curvilinee flex cm.60 (in busta)

576
serie di 3 curvilinee (in busta)

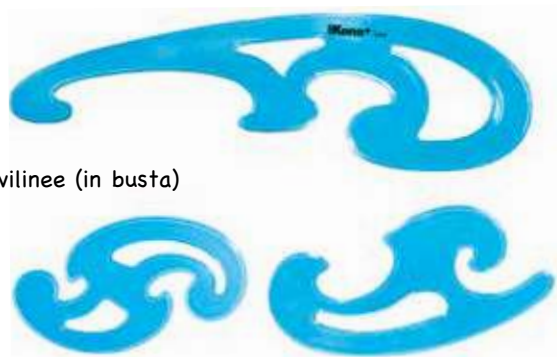

Righe antiluce

- 590 - cm.30
- 591 - cm.40
- 592 - cm.50
- 593 - cm.60
- 519 - cm.80
- 594 - cm.80 tecnic
- 595 - cm.100 tecnic

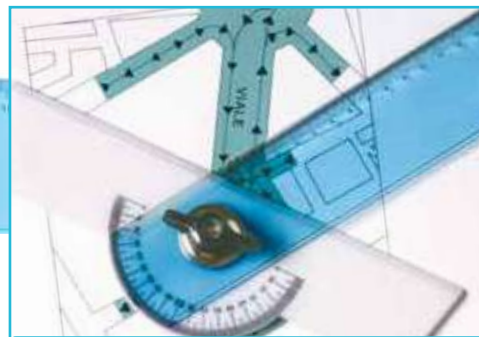

RIGHE A "T" ANTILUCE A TESTA MOBILE

- 596/50 - cm.50
- 596/70 - cm.70

● TAC50 riga cm.50

Riga in plexiglass da 50 cm. dotata di un robusto profilo in metallo che impedisce al cutter di incidere e rovinare la riga.

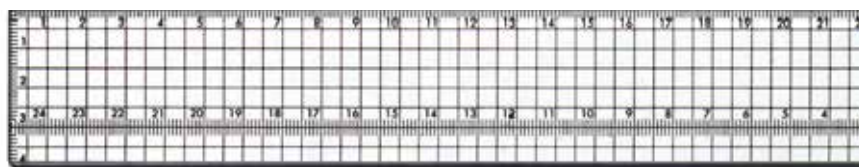

- 575/24**
CONFEZIONE SCUOLA
24 righelli cm.18
colori assortiti
- 511/20**
CONFEZIONE SCUOLA
20 doppi decimetri
con impugnatura



575/24



511/20



572/15

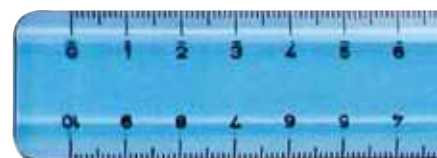

- 572/15**
CONFEZIONE SCUOLA
15 decimetri antiluce

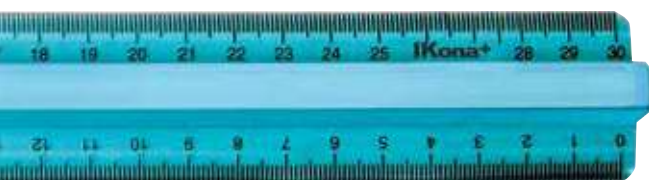

- 573**
triplo decimetro antiluce
con impugnatura

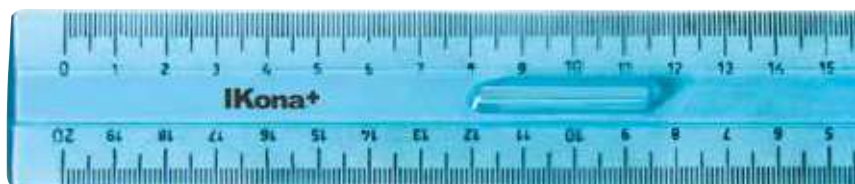

- 570 - doppio decimetro
- 571 - doppio decimetro con impugnatura

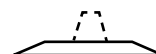

- Con impugnatura per una migliore presa
- Gradazioni stampate con tecnica UV, di facile lettura

- KR971172**
PACK SCUOLA 24 righelli cm.20
- KR971083**
PACK SCUOLA 24 righelli cm.30



CON
IMPUGNATURA

Maschere normografiche

Maschere normografiche in materiale acrilico consentono di ottenere una scrittura rapida con caratteri uniformi.

1/252



481



1/252 - riga normografica cm.30

481 - piastra disegno cm.9x31



1/251/2.5 - normografo n°2,5

1/251/3.5 - normografo n°3,5

1/251/5 - normografo n°5

1/251/7 - normografo n°7

1/251/10 - normografo n°10

1/251/14 - normografo n°14

1/251/20 - normografo n°20



CK1600

carattere "Arial Rounded"

altezza carattere cm.3

formato maschera cm.15,2x25



CK1597

carattere "Italic"

altezza carattere cm.2

formato maschera cm.15,5x25,5



1/250

4 MAXI maschere lettere/numeri da cm.5 - maschera cm.14x25

1/253

5 MAXI maschere lettere/numeri da cm.3 e 5 - maschera cm.14x25

1/254

10 MAXI maschere lettere/numeri da cm.10 - maschera cm.12x27,5

1/255

20 MAXI maschere lettere/numeri da cm.15 - maschera cm.16x21

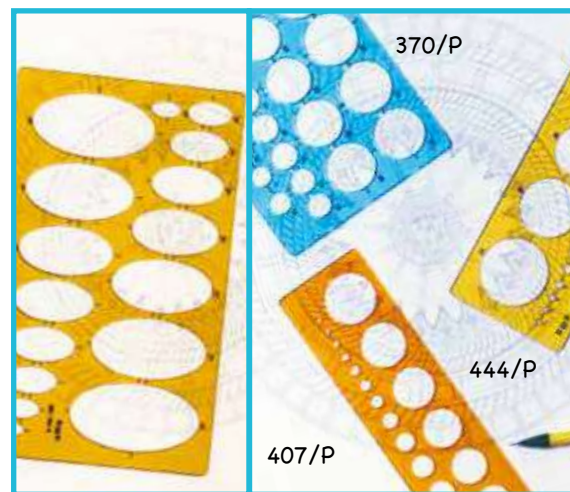

370/P

444/P

407/P

MASCHERA PER ELLISSI

480/P - cm.26x15

MASCHERA PER RACCORDI CIRCOLARI

407/P - cm.6x20

444/P - cm.7,5x23,5

370/P - cm.12x24

Squadre in alluminio

Serie di strumenti da disegno in alluminio anodizzato con millimetratura fotoincisa. Ideali per l'uso professionale e scolastico, resistenti agli urti e all'usura.

SQUADRA 45°

650 - squadra cm.25/45°

652 - squadra cm.31/45°

SQUADRA 60°

651 - squadra cm.25/60°

653 - squadra cm.31/60°



Righe e Righelli



MILLIMETRATURA FOTOINCISA

597/30 - cm.30

597/50 - cm.50

597/60 - cm.60

597/80 - cm.80

597/100 - cm.100



RIGHE A "T" IN ALLUMINIO A TESTA MOBILE

673 - riga a "T" cm.80



RIGHETTE IN ALLUMINIO

12282

barattolo 25 pezzi cm.15



665

doppio decimetro in alluminio con impugnatura

666

triplo decimetro in alluminio con impugnatura

Strumenti di misurazione

19

metro 10 stecche in legno

22 - doppio metro in legno



25/2

flessometro mt.2 con molla di rientro e freno

23/10 - rotella metrica mt.10

23/20 - rotella metrica mt.20

Strumenti di misurazione

morsetto

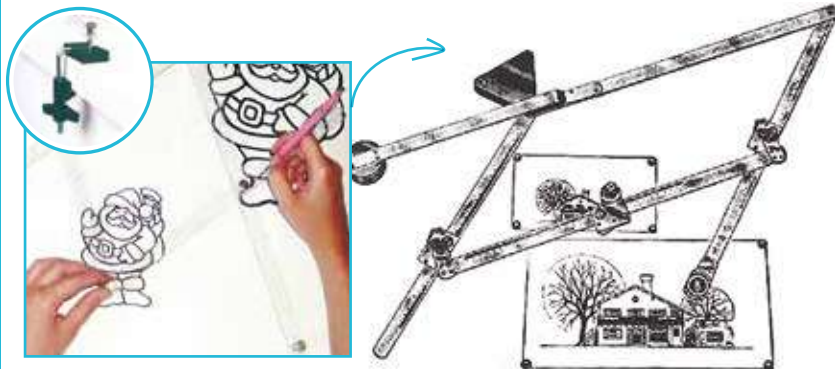

620

pantografo in perspex trasparente cm.35

Per riprodurre in maniera grafica qualsiasi disegno in scala maggiore, in scala naturale o in scala ridotta. Con morsetto di fissaggio al piano di lavoro.

I valori di ingrandimento (o di riduzione) sono incisi sulle aste e sono:
11/2- 2 - 21/4- 3 -31/2- 4 - 5 - 6 - 7 - 8 - 10

1/20

calibro in acciaio inox doppia tabella di precisione



Lavagne bifacciali

Lavagne in cartone scrivibili con marker a secco e cancellabili. Un lato bianco e uno quadrettato.

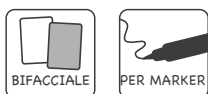

235 - cm.25x35

236 - cm.35x50

237 - cm.50x70

238 - cm.70x100

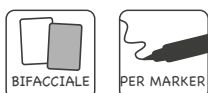

286 - cm.23x33 + 1 marker

310 Cancelleria e consumo

Lavagna adesiva "SCRICA"

Fogli-lavagna applicabili e utilizzabili ovunque.
Scrivibili con marker a secco, cancellabili e lavabili.

239/3 - cm.70x100



I FOGLI AUTOADESIVI POSSONO ESSERE
APPLICATI SU TUTTE LE SUPERFICI LISCE,
NON POROSE! CANCELLABILE!!

Lavagne nere

Lavagna nera scrivibile e cancellabile con cornice in legno, gesso e ganci di fissaggio inclusi.



11265/1 - cm.30x40
11265/2 - cm.40x60



GESO
E GANCI DI
FISSAGGIO
INCLUSI



11279/1 - cm.30x40
11279/2 - cm.40x60



58950
lavagnetta in ardesia cm.30x22
cornice in legno + spugna e 3 gessi



GESI E
CANCELLINO
INCLUSI



58952
lavagnetta in ardesia cm.26x19
cornice in legno + spugna e 3 gessi



Lavagne magnetiche

Lavagne magnetiche scrivibili e cancellabili con cornice in legno. Marker, 3 magneti e ganci di fissaggio inclusi.



MARKER
E GANCI DI
FISSAGGIO
INCLUSI



11281/1 - cm.30x40

11281/2 - cm.40x60

11281/3 - cm.60x90



MARKER,
MAGNETI
E GANCI DI
FISSAGGIO
INCLUSI



11277/1 - cm.30x40

11277/2 - cm.40x60

Lavagne magnetiche cancellabili, scrivibili con pennarelli a secco. Cornice in alluminio e angoli in ABS. Base portapennarelli su tutta la lunghezza. Nella confezione sono inclusi magneti, ganci, viti per fissaggio alle pareti.

08009 - cm.45x60

07822 - cm.60x90

12428 - cm.70x100

07823 - cm.90x120

07824 - cm.100x150

08010 - cm.100x200



Lavagna/bacheca magnetica con vetrinetta, anta di apertura in "crilex" trasparente munita di speciale sistema di chiusura. Cornice in alluminio. Angoli smussati.

● **11637** - cm.60x90

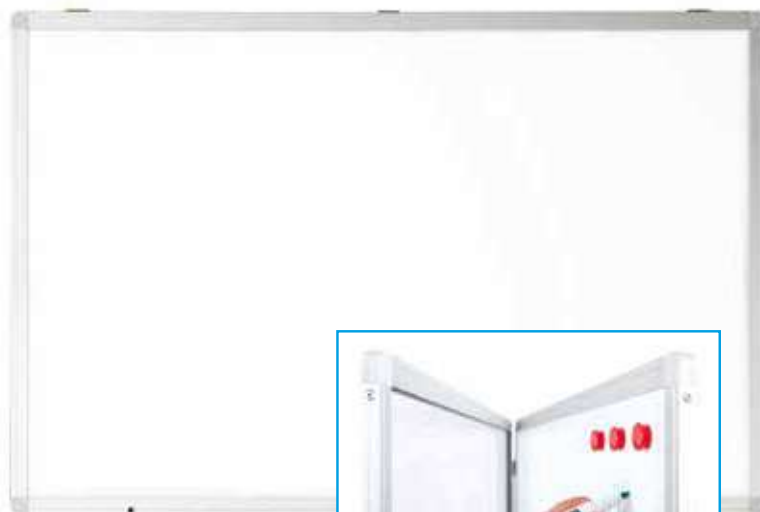

con vetrinetta



MAGNETI
E GANCI DI
FISSAGGIO
INCLUSI

Schermi da proiezione

pag.300
film trasparenti

Superficie opaca bianca. Manico ergonomico per una migliore portabilità, base in metallo a tre gambe con piedini in gomma. Include accessori per il montaggio.

11633
cm.145x195 con treppiede



Facile da montare a parete o soffitto. Superficie opaca bianca con un bordo nero per aumentare il contrasto delle immagini.

11634 - cm.122x165

Schermo da proiezione da muro MANUALE: Meccanismo di avvolgimento con azionamento a molla.

● **11635** - cm.145x195

Schermo da proiezione da muro ELETTRICO: Wireless. Azionabile con telecomando. Include telecomando e accessori per il montaggio.

Lavagna multiuso

Lavagna multiuso dotata di cornice con angoli arrotondati e portapennarelli su entrambi i lati. Montata su un robusto cavalletto che ne garantisce stabilità e ne consente la rotazione, la lavagna presenta un lato bianco magnetico per marker e un lato verde per gessetti.

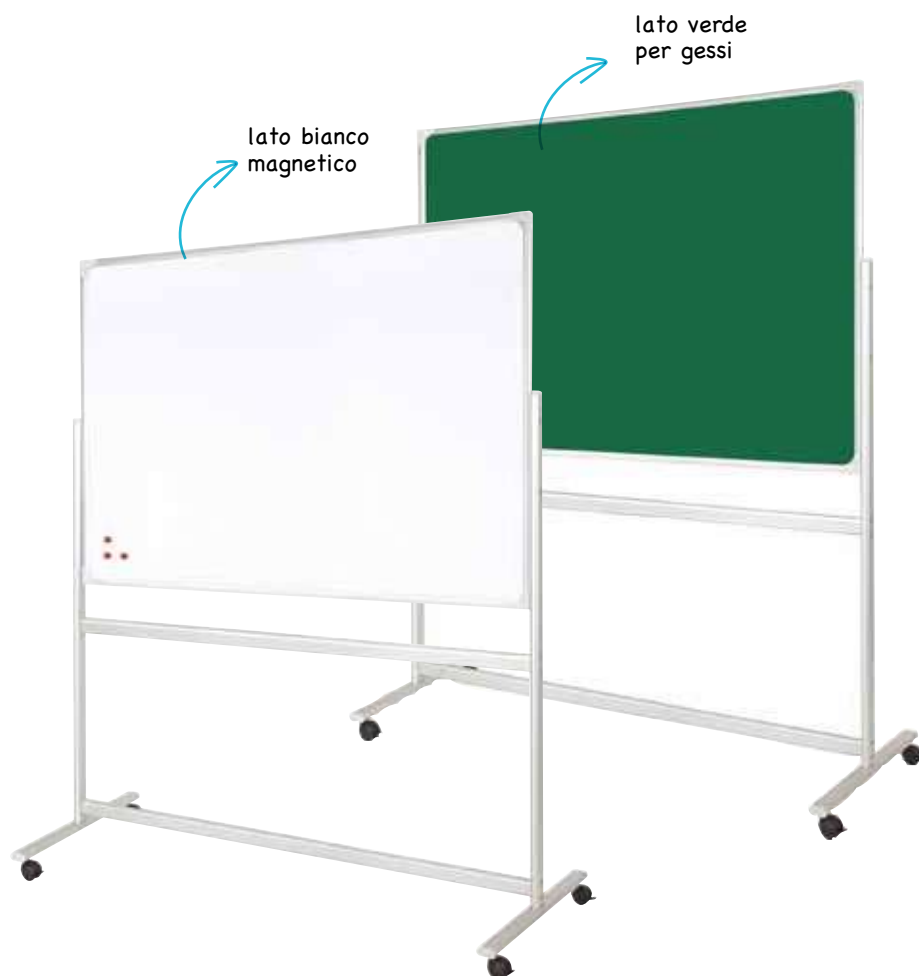
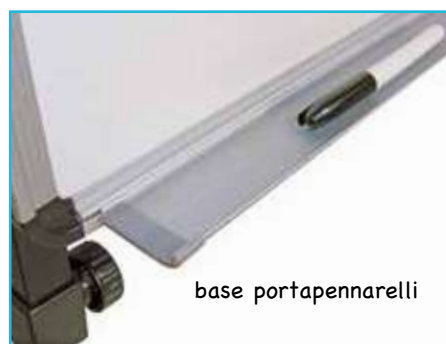

07821

lavagna magnetica con cavalletto
cm.120x90 (altezza totale cm.160)
un lato bianco per marker e un lato verde per gesso

Lavagna conferenza

Lavagna con cavalletto pieghevole per conferenze. Leggera e facile da trasportare con base portaoggetti. Fondo magnetico scrivibile e cancellabile.



11630

lavagna conferenza magnetica
con cavalletto - cm.70x100

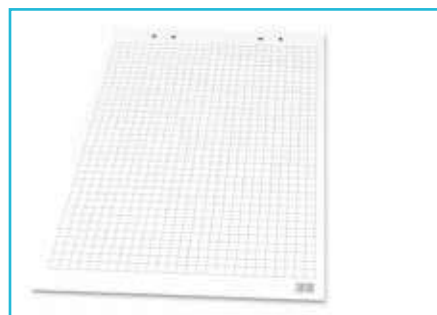

BLOCCHI CONFERENZA - 10 FOGLI

● **11632**

formato A1 - quadrettati

Cancellini



245

cancellino magnetico cm.4,5x5,5
con impugnatura



249

cancellino magnetico cm.4,5x15x3,5
con impugnatura



12586

cancellino magnetico cm.4,5x15
+ marker



247

cancellino in feltro cm.4,5x15x3,5
con impugnatura



12585x4

4 cancellini giganti cm.5,5x18
con impugnatura



09187

cancellino in feltro cm.6x7



241

cancellino in feltro ϕ cm.8,5x2,5



07582

cancellino in spugna ϕ cm.8
con impugnatura

Spugna facile da estrarre
e da lavare con acqua



Bacheche in sughero

pag.295
puntine



PUNTINE
INCLUDE

Bachecca in sughero appendibile sia verticalmente che orizzontalmente.

08011 - cm.45x60

08012 - cm.60x90

08013 - cm.90x120

08014 - cm.100x150



PUNTINE
E GANCI DI
FISSAGGIO
INCLUSI

11273/3

bachecca in sughero cm.60x90
Cornice in legno, fondo planisfero.
Puntine e ganci di fissaggio inclusi.



PUNTINE
E GANCI DI
FISSAGGIO
INCLUSI

Bachecca in sughero, cornice in legno.
Puntine e ganci di fissaggio inclusi.

11259/1 - cm.30x40

11259/2 - cm.40x60

11259/3 - cm.60x90



con vetrinetta



Bachecca in sughero con vetrinetta, anta di apertura munita di speciale sistema di chiusura. Cornice in alluminio. Angoli smussati. Puntine incluse.



PUNTINE
E GANCI DI
FISSAGGIO
INCLUSI

11276/2 - cm.40x60
(colori assortiti nell'imballo)



● **11636** - cm.60x90

● **07584** - cm.74x101

Accessori per lavagna

Fabbricati in robustissimo materiale acrilico, questi strumenti ad alta precisione sono indispensabili per l'insegnamento della geometria nelle scuole elementari, medie e superiori. Dal design moderno e colorato, dotati di una pratica impugnatura ergonomica rimovibile. Inoltre i decimetri sono evidenziati da una barra gialla, in modo tale da rendere più chiaro e comprensibile agli studenti il sistema metrico decimale.

- 230** - squadra cm.60/45°
- 231** - squadra cm.60/60°
- 232** - riga cm.100
- 233** - goniometro cm.50/180°

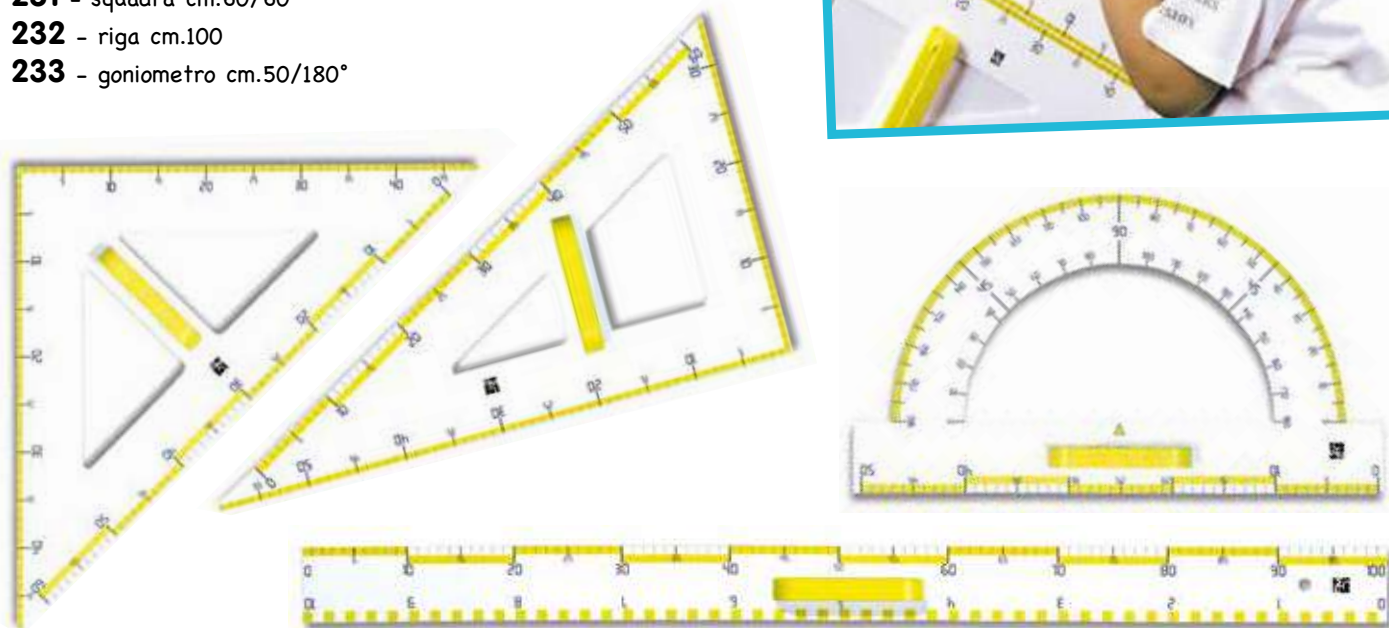

Kit scuola per lavagna

Kit scuola 5 strumenti per lavagna con pannello da parete in legno. Il pannello rigido si fissa alla parete con delle semplici viti, mentre tutti gli strumenti in robustissimo materiale acrilico sono sorretti da pratiche spinette. Il kit include una squadra cm.60/45°, una squadra cm.60/60°, una riga cm.100, goniometro cm.50/180°, un compasso cm.50 lunghezza.

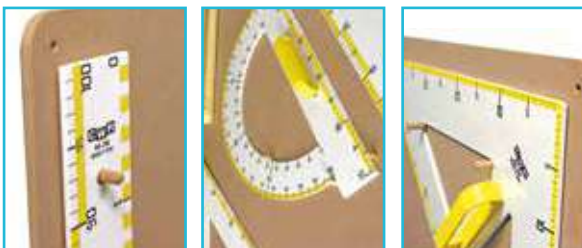

09253

set tecnico strumenti per lavagna
+ pannello in legno per fissaggio a muro

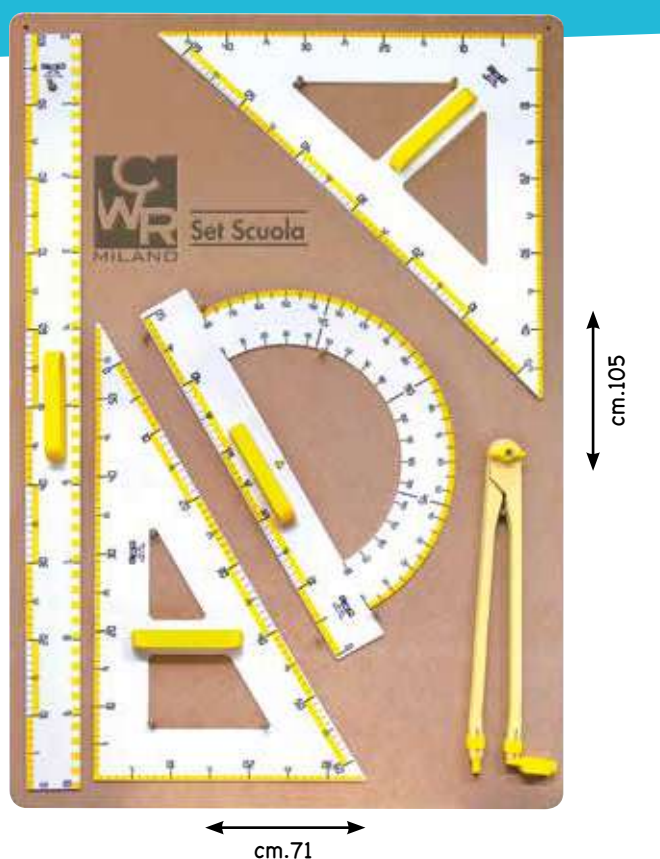

Accessori per lavagna

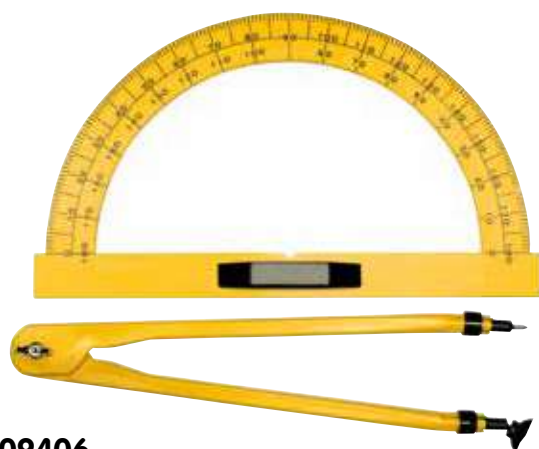

09406

set economico 5 strumenti per lavagna
in materiale acrilico, contiene:
2 squadre, 1 riga, 1 compasso, 1 goniometro



Compassi per lavagna

La punta ha due possibilità d'uso: una parte é ideata per superfici ruvide, l'altra parte invece é dotata di un gommino che permette di lavorare su superfici lisce. L'altro braccio del compasso è provvisto di un adattatore che consente di disegnare cerchi con gessi, marker, cutter e pennelli.

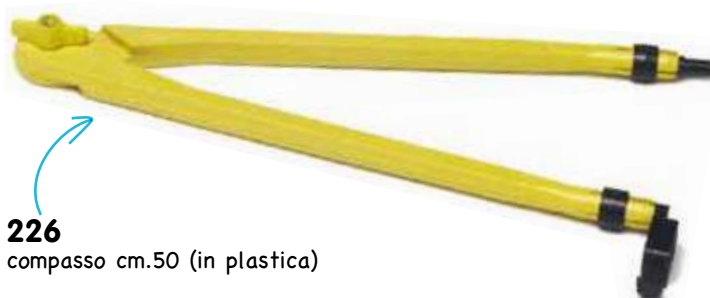

226

compasso cm.50 (in plastica)



2495/20x24

24 magneti \varnothing cm.2

2495/30x24

24 magneti \varnothing cm.3

2495/40x24

24 magneti \varnothing cm.4



T320

12 bottoni magnetici \varnothing cm.2

11258

6 bottoni magnetici \varnothing cm.3

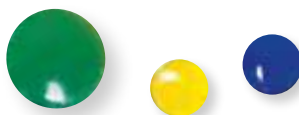

T0214

clip magnetica in metallo
cromato cm.3. Ideale per
appendere fogli a lavagne,
bacheche, scaffali, ecc...

Plastica trasparente

1770/25

rotolo cm.100x25 mt. trasparente

CONFEZIONE 3 FOGLI CM.100x130

1766/3 - trasparente

1765/3 - fantasia

CONFEZIONE 25 FOGLI CM.100x130

1765/25 - trasparente

1764/25 - stampata

06068

5 rotoli cm.70x500
colori trasparenti assortiti

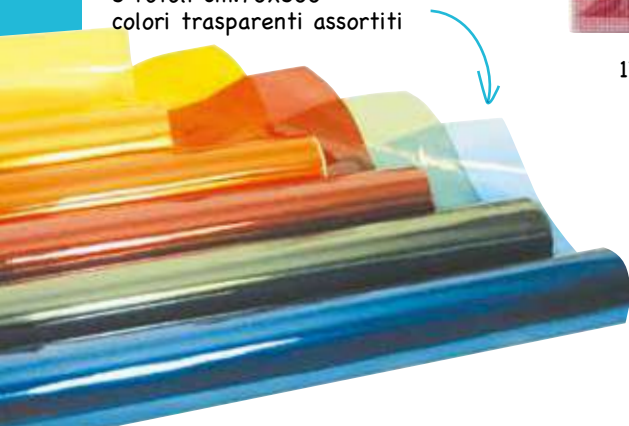

1765/3

Paglietta cellophane

1768 - sacchetto gr.300

09902 - conf. kg.1

1768/5 - conf. kg.5

09903

OFFERTA 12 confezioni kg.1



Truciolo in carta

BUSTA GR.100

1767/1 - rosso

1767/2 - giallo

1767/3 - verde



Sacchetti di carta

SACCHETTO IN CARTA - CONF. 25 PEZZI

Borsa a soffiato in carta kraft
maniglia in carta ritorta.

COLORE BIANCO

11284 - cm.16x8x21

11285 - cm.22x10x27

11286 - cm.26x12x36

11287 - cm.36x12x41

COLORE AVANA

11288 - cm.16x8x21

11289 - cm.22x10x27

11290 - cm.26x12x36

11291 - cm.36x12x41



SACCHETTO PLASTIFICATO
CONFEZIONE 25 PEZZI

Monopatinata 130 gr.
Plastificazione lucida.

COLORE BIANCO

● **11302** - cm.25x11x31

SACCHETTO PLASTIFICATO - CONF. 25 PEZZI

Monopatinata 130 gr. Plastificazione lucida.

COLORE ROSSO

11298 - cm.16x8x24

11299 - cm.25x11x31

11300 - cm.36x12x40

Carta da pacco

Resistente, tenace, duttile e robusta. Ideale per imballare ogni sorta di oggetto e quindi particolarmente indicata per magazzini, uffici postali.

GR.80 BIANCA

- 08159** - cm.35x20 mt. (rotolo)
- 09144** - cm.70x10 mt. (rotolo)
- 1020** - cm.70x20 mt. (rotolo)
- 07106** - cm.70x50 mt. (rotolo)
- 07107** - cm.100x10 mt. (rotolo)
- 07108** - cm.100x50 mt. (rotolo)
- 05680** - cm.150x10 mt. (rotolo)
- 09690** - cm.100x150 (fogli 1 kg.)
- 1021** - cm.100x150 (fogli 5 kg.)
- 1024** - cm.100x150 (20 fogli piegati)

GR.90 BIANCA

- 08023** - cm.42x50 mt. (rotolo)

GR.100 BIANCA

- 08777** - cm.100x20 mt. (rotolo)
- 04168** - cm.100x150 (4 fogli piegati)



GR.60 AVANA

- 1027** - cm.70x5 MT. (rotolo)
- 05703** - cm.70x20 MT. (rotolo)
- 11940** - cm.100x10 MT. (rotolo)
- 11941** - cm.100x25 MT. (rotolo)

GR.80 AVANA

- 1031** - cm.75x100 (20 fogli piegati)
- 1023** - cm.100x150 (20 fogli)
- 09691** - cm.100x150 (fogli, 1 KG.)
- 1022** - cm.100x150 (41 fogli, 5 KG.)
- 08778** - cm.100x50 MT. (rotolo, 4 KG.)



1036/2

100 fermagli postali grandi adatti per spago medio e grosso

1037

Kit da pacco
Barattolo contenente un gomitolo da gr.100 di spago in canapa (misura 2,2 medio) e 25 fermagli postali. Un foro sul coperchio del barattolo consente di sfilare lo spago a seconda della necessità.



FINE (2,6)

1039

gr.100 - mt.70 circa
BIANCO
Ideale per alimenti



FINE (2,6)

1032/3

gr.100 - mt.65 circa
1032/3/500
gr.500 - mt.260 circa



MEDIO-FINE (2,4)

1032/24

gr.100 - mt.35 circa



MEDIO (2,2)

1032/2

gr.100 - mt.25 circa
1032/2/500
gr.500 - mt.125 circa



GROSSO (2-3/4)

1032/1

gr.100 - mt.18 circa
1032/1/500
gr.500 - mt.90 circa

Scatole

SCATOLE AUTOMONTANTI IN MICROONDA

Per assemblarle non servono colle o adesivi: basta incastrare le linguette.

04911x5

5 scatole cm.16x21x11 h

04910x5

5 scatole cm.14x16x8 h

07460x10

10 scatole mm.162x83x97 h - bianco

07461x10

10 scatole mm.220x73x100 h - bianco

07462x10

10 scatole mm.125x43x155 h - bianco

07463x10

10 scatole mm.305x218x24 h - bianco

07464x10

10 scatole mm.215x73x25 h - bianco

07465x10

10 scatole mm.330x160x170 h - avana

07466x10

10 scatole mm.320x250x80 h - avana

07467x10

10 scatole mm.225x145x105 h - bianco

07468x10

10 scatole mm.252x170x140 h - bianco

07529x10

10 scatole mm.100x100x100 h - bianco



12007

scatola cm.12,5x12,5x7 h

12008

scatola cm.17,5x12,5x7 h



11387

cm.22x5x5 h
(minimo: 50 pezzi)



07577 - cm.50x30x18 h

07123 - cm.35x25x17 h

Scatole con coperchio, fornite stese.
Ideali per riporre giochi, abiti o per
imballare e archiviare.

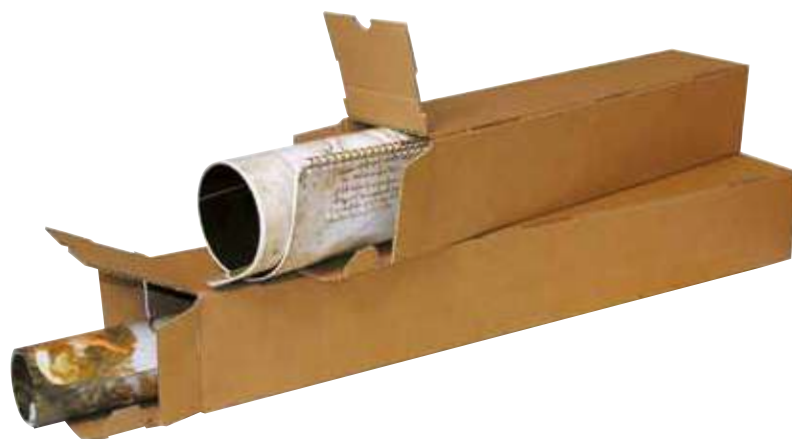

07644x10 - 10 scatole cm.10x10x50

07645x10 - 10 scatole cm.10x10x70

11393x10 - 10 scatole cm.10x10x101

Scatole in cartone per spedire e archiviare
poster, cartelloni, rotoli di stoffa, profilati...

Buste zip



20 BUSTE CON CHIUSURA ZIP

1794 - cm.7x12

1795 - cm.10x12

1800 - cm.10x20

1801 - cm.20x30

1802 - cm.30x45



Buste imbottite

Indicate per oggetti fragili. Chiusura autoadesiva e protezione rinforzata lungo tutti i bordi.

10 BUSTE IMBOTTITE

05769 - cm.18x26,5

● **05770** - cm.24x34

05771 - cm.27x36

50 BUSTE MILLEUSI
CON CHIUSURA ADESIVA

03660 - cm.13x28

03661 - cm.15x23

03662 - cm.22x30

03663 - cm.25x33

03664 - cm.30x38

04941 - cm.31x43

04919 - cm.37x53

04918 - cm.52x73

100 BUSTE MILLEUSI

03655 - cm.13x30

03656 - cm.15x25

03657 - cm.22x32

03658 - cm.25x35

03659 - cm.30x40

Contenitore-Portariviste archivio

Ideale per conservare cataloghi, riviste e brochure formato A4. Con area etichettabile sul dorso. I contenitori sono archiviabili anche orizzontalmente.



12229x10

10 contenitori archivio in cartone
cm.26x8,5x35 h



07603x10

10 portariviste in cartone
cm.25x8,5x34,5 h



Attaccaglie e chiodini

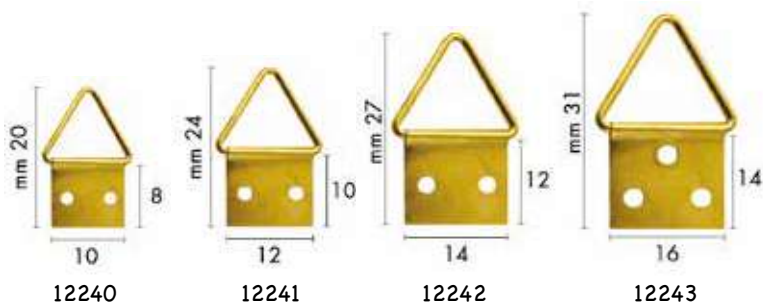

ATTACCAGLIE SNODATE IN FERRO OTTONATO

- 12240** - busta 10 pezzi (chiodini inclusi)
- 12241** - busta 10 pezzi (chiodini inclusi)
- 12242** - busta 10 pezzi (chiodini inclusi)
- 12243** - busta 10 pezzi (chiodini inclusi)



ATTACCAGLIA A PONTICELLO

- 12570**
busta 4 attaccaglie a ponticello (viti incluse)



ATTACCAGLIA DENTATA

- 12571**
busta 4 attaccaglie dentate (chiodini inclusi)



ATTACCAGLIA FISSA IN FERRO OTTONATO

- 12244**
busta 4 pezzi (chiodini inclusi)



SQUADRETTA ANGOLARE

- 12569**
busta 4 squadrette angolari
cm.10x10 (viti incluse)



- 12274**
(cm.1 x ϕ 1,5 mm)
- 12277**
(cm.2 x ϕ 2 mm)
- 12275**
(cm.2 x ϕ 1,3 mm)

CHIODINI

- 12274** - 100 chiodini circa
(per art. da 12240 a 12243)
- 12277** - 50 chiodini circa (per 12244)
- 12275** - 70 chiodini temperati



TASSELLO IN ACCIAIO

- 12245**
busta 4 pezzi ϕ cm.8x55 mm

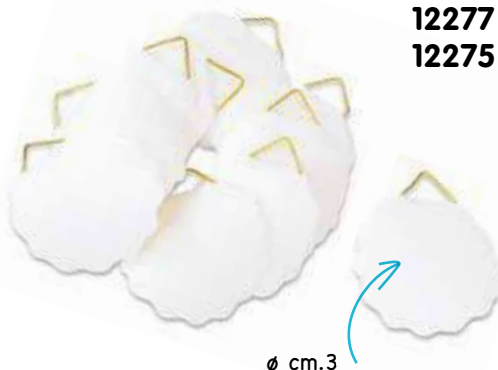

GANCINI ADESIVI IN TESSUTO

- 06497** - 100 gancini ϕ cm.3
- 06549** - 12 gancini ϕ cm.3



ATTACCAGLIA ADESIVA

- 12568**
busta 12 attaccaglie adesive
trasparenti

Plastica a bolle

1029

rotolo mt.7,5x50 cm. h

06100

bobina mt.10x1 h

05773

bobina mt.100x1 h



PER
IMBALLAGGI
FRAGILI



Telo isolante ISOFELT

Piano di lavoro composto da un feltro con grandi capacità di assorbimento e ritenzione dei liquidi in grado di isolare e proteggere le superfici sottostanti. Il retro di ISOFELT è provvisto di una pellicola impermeabile antiscivolo che ne assicura l'aderenza e la stabilità.

NIENTE
MACCHIE,
RUMORI,
UMIDITÀ

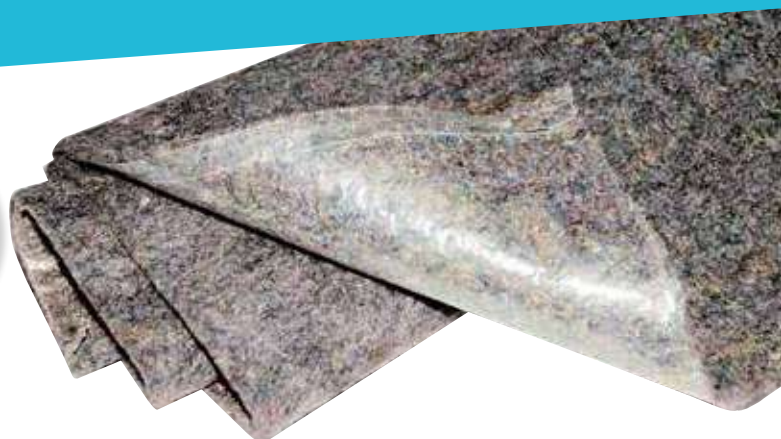

RIUTILIZZABILE!

07730 - cm.33x70

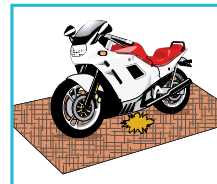

Telo copritutto

Telo in polietilene ideale per ricoprire tutti quegli oggetti che devono essere preservati dalla polvere, dall'usura del tempo o da gocce di vernice in caso di imbiancatura. Grazie alle grandi dimensioni, il telo copritutto consente di ricoprire e proteggere in modo pratico e veloce mobili, macchinari, automobili e ogni altro oggetto.

1015/16

telo copritutto mt.4x4



METRI
4x4



Portaetichette magnetico

Comodo sistema per poter cambiare qualsiasi scritta. Tagliabile nella misura desiderata utilizzando un paio di forbici.



07872

10 portaetichette cm.10x4 h completo di cartoncino bianco



Bordo magnetico per magnetizzare le etichette

2490/20 -

bordo magnetico mt. 1x2 cm. h

2490/40 -

bordo magnetico mt. 1x4 cm. h



Un lato magnetico
e un lato adesivo!

04689

banda magnetica adesiva cm.50x5 h

07874

banda magnetica adesiva mt.1x5cm. h

Nastro da imballo silenzioso

Per la chiusura di imballaggi in cartone. Resistente alla rottura, all'umidità e all'abrasione. Ottima adesione al cartone da imballo. Produce pochissimo rumore quando sbobinato. Film di polipropilene. Adesivo acrilico a base acqua.



77/5066

cm.50x66 mt. avana

78/5066

cm.50x66 mt. trasparente

OTTIMA
ADESIONE,
RESISTENTISSIMO
E SILENZIOSO



08836

cm.39x68x181 h

Armadio a due ante in materiale plastico con divisorio verticale e tre ripiani interni regolabili. Pratica apertura delle ante fino a 180°. Chiusura con lucchetto (non incluso).

Il Decreto D. M. n° 388 del 15/07/2003, come da pubblicazione sulla Gazzetta Ufficiale del 03/02/2004 prevede l'obbligo di tenere un set di Pronto Soccorso a norma in tutti gli ambienti di lavoro. Il set di Pronto Soccorso dev'essere scelto in base alla categoria di rischio a cui si appartiene (vedi **ALLEGATO 1** e **ALLEGATO 2**).

ALLEGATO 1

- Indicato per luoghi di lavoro da 3 a più lavoratori.
Ad esempio: scuole, uffici, enti, supermercati, ecc...

08143 - armadietto Pronto Soccorso armadietto in metallo colore bianco, 3 vani, 2 ripiani interni, serratura con chiave (cm.30x14x46 h, peso Kg.7,5)

Contenuto:

- 1 Copia Decreto Min 388 del 15.07.03
- 5 Paia di guanti sterili
- 1 Mascherina con visiera paraschizzi
- 3 Flaconi soluzione fisiologica sterile 500 ml.
- 2 Flaconi disinfettante 500 ml. IODOPOVIDONE al 10% Iodio PMC
- 10 Buste garza sterile cm.10 x 10
- 2 Buste garza sterile cm.18 x 40
- 2 Teli sterili cm.40 x 60 DIN 13152-BR
- 2 Pinze sterili
- 1 Confezione di cotone idrofilo
- 1 Astuccio benda tubolare elastica
- 2 PLASTOSAN 10 cerotti assortiti
- 2 Rocchetti cerotto adesivo m.5 x 2,5 cm.
- 1 Paio di forbici tagliabendaggi cm.14,5
- 3 Lacci emostatici
- 2 ICE PACK ghiaccio istantaneo
- 2 Sacchetti per rifiuti sanitari
- 1 Termometro clinico CE con astuccio
- 1 Sfigmomanometro PERSONAL con fonendo
- 1 Istruzioni MULTILINGUA Pronto Soccorso



08145 - valigetta Pronto Soccorso con supporto per attacco a parete, maniglia per trasporto, con due clip rotanti (cm.46x34,5x14,5 h peso Kg.5,50)

Contenuto:

- 1 Copia Decreto Min 388 del 15.07.03
- 5 Paia di guanti sterili
- 1 Mascherina con visiera paraschizzi
- 3 Flaconi soluzione fisiologica sterile 500 ml.
- 2 Flaconi disinfettante 500 ml. IODOPOVIDONE al 10% Iodio PMC
- 10 Buste garza sterile cm.10 x 10
- 2 Buste garza sterile cm.18 x 40
- 2 Teli sterili cm.40 x 60 DIN 13152-BR
- 2 Pinze sterili
- 1 Confezione di cotone idrofilo
- 1 Astuccio benda tubolare elastica
- 2 PLASTOSAN 10 cerotti assortiti
- 2 Rocchetti cerotto adesivo m.5 x 2,5 cm.
- 1 Paio di forbici tagliabendaggi cm.14,5
- 3 Lacci emostatici
- 2 ICE PACK ghiaccio istantaneo
- 2 Sacchetti per rifiuti sanitari minigrigip
- 1 Termometro clinico CE con astuccio
- 1 Sfigmomanometro PERSONAL con fonendo
- 1 Istruzioni MULTILINGUA Pronto Soccorso



08147

kit riassortimento Pronto Soccorso (Include tutto il contenuto dell'art.08145 ad eccezione dello sfigmomanometro)

08153

sacchetto ghiaccio istantaneo monouso, per traumi o emorragie. Fornito in sacchetti in materiale plastico o rivestito in TNT



ALLEGATO 2

- Indicato per luoghi di lavoro con massimo 2 lavoratori.
Ad esempio: negozi, piccoli uffici, furgoni, ecc...

08142 - armadietto Pronto Soccorso armadietto realizzato in plastica colore bianco, 3 vani, 2 ripiani interni, chiusura a scatto (cm.37x22x14 h, peso Kg.2,10)

Contenuto:

- 1 Copia Decreto Min 388 del 15.07.03
- 2 Paia di guanti sterili
- 1 Flacone disinfettante 500 ml. IODOPOVIDONE al 10% Iodio PMC
- 1 Soluzione fisiologica sterile 250 ml.
- 1 Busta garza sterile cm.18 x 40
- 3 Buste garza sterile cm.10 x 10
- 1 Pinza sterile
- 1 Confezione 10 cerotti assortiti
- 1 Rocchetto cerotto adesivo m.5 x 2,5 cm.
- 1 Benda di garza da m. 3,5 x 10 cm.
- 1 Paio di forbici tagliabendaggi cm.14,5
- 1 Laccio emostatico
- 1 ICE PACK ghiaccio istantaneo
- 1 Sacchetto per rifiuti sanitari
- 1 Istruzioni MULTILINGUA Pronto Soccorso



08144 - valigetta Pronto Soccorso con supporto per attacco a parete, maniglia per trasporto, chiusura con due clip rotanti (cm.29x21,5x9 h peso Kg.1,22)

Contenuto:

- 1 Copia Decreto Min 388 del 15.07.03
- 2 Paia di guanti sterili
- 1 Flacone disinfettante 500 ml. IODOPOVIDONE al 10% Iodio PMC
- 1 Flacone soluzione fisiologica sterile 250 ml.
- 1 Busta garza sterile cm.18 x 40
- 3 Buste garza sterile cm.10 x 10
- 1 Pinza sterile
- 1 Confezione di cotone idrofilo
- 1 PLASTOSAN 10 cerotti assortiti
- 1 Rocchetto cerotto adesivo m.5 x 2,5 cm.
- 1 Benda di garza da m. 3,5 x 10 cm.
- 1 Paio di forbici tagliabendaggi cm.14,5
- 1 Laccio emostatico
- 1 ICE PACK ghiaccio istantaneo
- 1 Sacchetto per rifiuti sanitari mm.250 x 350
- 1 Istruzioni MULTILINGUA Pronto Soccorso



08146

kit riassortimento Pronto Soccorso (Include tutto il contenuto dell'art.08144)



08151

scatola 100 cerotti assortiti (8 misure)



Pulizia e igiene



LINEA PROFESSIONALE

11919
ZERO-VETRI linea professionale
pulizia vetri e specchi PRO ml.750

11922
ZERO-WC linea professionale
disincrostante detergente PRO ml.750



LINEA PROFESSIONALE

11920
CREMA-DET
crema ammoniacale ml.500

11921
ZERO-CALC linea professionale
crema ammoniacale PRO litri 1



LINEA PROFESSIONALE

11917
ZERO-MACCHIE linea professionale
detergente multisuperfici PRO ml.750

11918
ZERO-GRASSO linea professionale
sgrassante spray PRO ml.750



LINEA PROFESSIONALE

11915
ZERO-PAVIBRILL linea professionale
detergente pavimenti PRO litri 5



11924
sapone liquido mani
ricarica litri 5



12554
detergente
disinfettante ml.75



11927
set 3 spugne accoppiate
abrasiva/morbida



08164
confezione 220 asciugamani
monouso piegati
2 veli cm.23x23,5



08161
rotolo strofinaccio 2 veli
800 strappi

06828x25
25 sacchi neri per rifiuti
27 micron cm.50x60 h
capacità litri 25 - nero



10 sacchi cm.70x110
11931/1 - nero
11931/2 - giallo
11931/3 - bianco
11931/4 - viola



08162
carta igienica confezione 10 rotoli
2 veli (ogni rotolo mt.17) 155 strappi



08945
busta 100 soprascarpe



08141
rotolo lenzuolo medico 2 veli 216 strappi
lunghezza mt.80x60 cm.

Prime esperienze di gioco



L'espressione "Imparare giocando" è un termine usato in pedagogia per descrivere come un bambino piccolo possa imparare tramite il gioco a dare un senso al mondo che lo circonda. Attraverso il gioco i bambini possono sviluppare abilità sociali e cognitive, maturare emotivamente e acquisire la fiducia in se stessi. In questo capitolo presentiamo proposte destinate ai più piccoli e alle prime, intense esplorazioni di ciò che li circonda.

342 Giochi sensoriali

356 Costruzioni

373 Veicoli
GO-GO



388 Imparare
giocando

Morbidi giochi



09762

tappeto degli animali DOUBLE-FACE



Imbottito per il massimo del comfort e morbidezza.

Può essere utilizzato da entrambi i lati.

Su un lato sono raffigurati simpatici animalotti, alcuni dotati di sonagli, altri di morbidi elementi mobili o a rilievo, specchietti di sicurezza...

13118

pupazzi morbidi per giochi d'acqua
6 soggetti assortiti



Con acqua!

08257

chiavi refrigeranti per dentizione
Contengono acqua per refrigerare
e massaggiare le gengive dei
bambini e favorire la dentizione.



06444

Mamma Chioccia e pulcini
I pulcini sono anelli didattici a forma
di "C" che possono essere staccati e
riattaccati da mamma chioccia.



Con sonaglio,
foglio piega, squittio,
fagioli di plastica per
lo sviluppo sensoriale!



65100

sonaglio SOLE in morbido cotone



BB512

palla multiattività in morbida felpa



732370

catenella portaciuccio (in legno)



733840

sonaglietto con palline (in legno)



2 in 1 quadriciclo e girello



SI3000GR

"cammina e cavalca" (in plastica)



Un gioco multiuso: girello e quadriciclo! Massimo supporto e stabilità. I piccoli possono imparare a camminare in sicurezza. Utilizzabile sia all'interno che all'esterno su qualsiasi superficie liscia e piana.



BB069

giraffa trainabile (in legno)



763770

palestrina regolabile in tre altezze (in legno e metallo)



BJ601

trottola dei colori





BB108

fattoria delle forme (in legno)

CM.26x14x16,5

+1 ANNI

11 PEZZI

I bambini devono fare entrare ogni animaletto nella fattoria infilandolo nella forma corrispondente che si trova sulle pareti. Il tetto apribile consente di estrarre gli animaletti e ricominciare a giocare. Dotato di pratica maniglia per il trasporto.

58864

batti e ribatti (in legno)

CM.18x18x8

+1 ANNI



Ideale per sviluppare la coordinazione occhio/mano. Solida struttura in legno con angoli smussati, martello arrotondato. Una volta inseriti tutti i chiodoni, basta capovolgere la struttura per ricominciare a giocare.



58580

scatola delle forme (in legno)

CM.16x16x7,6

+1 ANNI

5 PEZZI



BB096

cilindro delle forme (in legno)

CM.15x12,5

+1 ANNI

7 PEZZI



Trainabili



54977

lumaca trainabile (in legno) con guscio mobile



CM.18

+18
MESI



BB037

treno con vagoni (in legno)



CM.55

+18
MESI

28
PEZZI



54988

famiglia delle anatre trainabili (in legno)



CM.55

+18
MESI

BB111

gatto trainabile (in legno)



CM.28x21

+18
MESI



Giochi multiattività



BB115

pannello multiattività "Il giardino" (in legno)



+1
ANNI

CM.31,5x40,5x6,5

Il pannello multiattività incoraggia la destrezza e contribuisce allo sviluppo delle abilità di coordinazione dei più piccoli. Tante attività legate al tema dei fiori e degli insetti, con svariati elementi mobili da osservare e spostare. Completo di cinghie per fissaggio al lettino.



Un gioco sempre vario e divertente! Su due lati ci sono giochi di insiemistica e coordinazione con numeri e animali, sugli altri due lati trovate un pannello lavagna scrivibile con gessi, un pallottoliere e blocchi con alfabeto e figure (i cui nomi sono scritti in inglese).

BB054

gioco multiattività "triangolo" (in legno)



+1
ANNI

CM.29x25,5x22,5



LATO 1



LATO 2

LATO 3

Impilabili

WM034

tavola 4 torri impilabili (in legno)



+1
ANNI



BJ376

gioco degli ingranaggi (in legno)



+2
ANNI

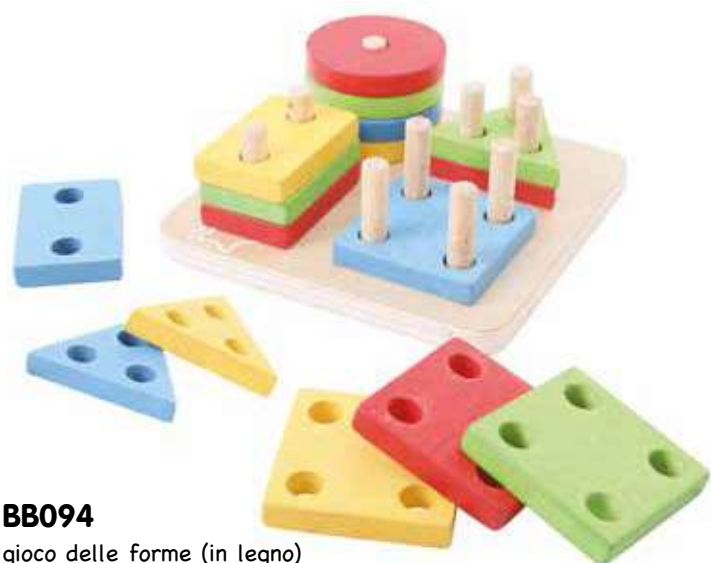

BB094

gioco delle forme (in legno)



+1
ANNI

Gigante!



BB040

tavola gigante delle forme (in legno)



+1
ANNI



BB104

"Creo gli animali" (in legno)



CM.7x18x18



BB125

trattore (in legno)



CM.17x13



BB109

nave pirata (in legno)



CM.20x23



Cubi Impilabili

I cubi devono essere impilati nell'ordine corretto, dal più grande al più piccolo, per creare una torre. Ogni blocco raffigura un'immagine, un numero e punti che corrispondono al numero sul blocco. Questi giochi costituiscono un valido aiuto per l'apprendimento e incoraggiano il calcolo precoce, l'alfabetizzazione, il riconoscimento di colori e forme, lo sviluppo del vocabolario e della coordinazione.



BJ696

cubi impilabili "Animali del cortile" (in cartone)

CM.15x15

+1 ANNI

10 PEZZI

11441

eco-cubi della natura impilabili (in cartone)

+ 1 libretto cm.11x11

CM.16x16x16

+2 ANNI

10 PEZZI

Impilabili



58577

57961

58893

BB107

58577

principe impilabile (in legno)



CM.15 H

+1 ANNI

6 PEZZI

57961

omino impilabile (in legno)



CM.21 H

+1 ANNI

9 PEZZI

58893

"torre delle forme" (in legno)



CM.27,5 H

+1 ANNI

9 PEZZI

BB107

"torre dei numeri" (in legno)



CM.28,5 H

+1 ANNI

11 PEZZI

Giochi di equilibrio

Impila ogni pezzo senza far cadere nulla. Questi giochi sviluppano la coordinazione occhio/mano, le capacità motorie e la destrezza. Incoraggia la risoluzione dei problemi.



BJ256

"Ombrello del meteo" (in legno)



CM.18x16

+2 ANNI

13 PEZZI



Mela, banana, uva, fragola... in equilibrio!



BJ255

"L'equilibrio della frutta" (in legno)



CM.18x7

+2 ANNI

13 PEZZI

Giochi di equilibrio

Le possibilità di gioco sono infinite con i giochi di equilibrio. Senza linee guida o regole, i giovani creativi possono impilare in tutti i modi possibili, facendo attenzione all'equilibrio! Sviluppano la manualità e la capacità di ragionamento spaziale.



BB144

torre impilabile arcobaleno
(in legno)



+18
MESI

6
PEZZI



04683

puzzle rana (in legno)



+1
ANNI

6
PEZZI



04680

super tartaruga (in legno)



+1
ANNI

6
PEZZI



Sui due lati
sono raffigurati
due diversi tipi di
abitazione:
palazzo e villetta!



04679

casetta impilabile (in legno)



+1
ANNI

7
PEZZI



Giochi di esplorazione sensoriale



spessore da cm.1 a cm.1,7

06969

piastrelle tattili (materiali sensoriali assortiti)



CM.13,5x23,5



+2
ANNI



12
PEZZI



Questo gioco favorisce l'esperienza, l'approccio e la discriminazione di diversi materiali, ognuno dei quali dà origine a particolari sensazioni tattili (ruvidità, morbidezza, calore...). Utilizzabile sia con gli arti superiori che con quelli inferiori, oppure per organizzare percorsi motori complessi.



spessore da cm.1 a cm.1,7

08721

dischi tattili (materiali sensoriali assortiti)

6 dischi ø cm.21 + 6 dischi ø cm.8



CM.21x21



+2
ANNI



12
PEZZI



Il set contiene 6 dischi grandi da posizionare sul pavimento, e 6 dischi più piccoli, da tavolo, per inventare giochi tattili con le mani. Ognuno dei 6 dischi è fabbricato con un materiale diverso dagli altri, così da stimolare la curiosità tattile dei bambini.



08761

grande percorso sensoriale
(materiali sensoriali assortiti)
16 piastrelle cm.32x32 + 8 dischetti ø cm.8



Il grande percorso sensoriale favorisce l'approccio e la discriminazione di 8 materiali ognuno dei quali dà origine a particolari sensazioni tattili. Composto da 16 grandi piastrelle tattili con fondo in gomma antitrauma, spessore mm.9. Per approfondire il confronto tra le varie superfici tattili è possibile utilizzare i dischetti di riconoscimento inclusi nel set: il bambino dovrà toccare con le mani la superficie riportata sul dischetto e riconoscere la stessa superficie sulle piastrelle, utilizzando i piedini.



10387

tavole/puzzle sensoriali in legno
(materiali sensoriali assortiti)



10348

tavole sensoriali in legno
(materiali sensoriali assortiti)



pag.584
percorsi motori

Forme tattili in feltro

Forme in feltro con fondo antiscivolo GECO (dotate di ventose in gomma che assicurano una perfetta aderenza al pavimento). Ideali per percorsi tattili e psicomotori al fine di sviluppare la coordinazione del bambino. Ignifugo, classe 1. Spessore 2,5 mm.

08691

feltro triangolo cm.32x45° (4 pz. colori assortiti)

08689

feltro quadrato cm.32x32 (4 pz. colori assortiti)

08687

feltro cerchio ø cm.32 (4 pz. colori assortiti)

08699

feltro cerchio ø cm.22 (4 pz. colori assortiti)

08698

feltro cerchio ø cm.22 (12 pz. colori assortiti)

08686

feltri per percorsi motori (colori assortiti)
forme: cerchio, rettangolo, esagono
cerchio ø cm.22 (12 pz.)

08688

feltri per percorsi motori (colori assortiti)
forme: cerchio, quadrato, triangolo
cerchio ø cm.32 (12 pz.)

+2
ANNI

12
PEZZI



11395

dischi in feltro per percorsi motori (colori assortiti)



+2
ANNI

24
PEZZI



11394

feltri per percorsi motori (colori assortiti)



+2
ANNI

12
PEZZI

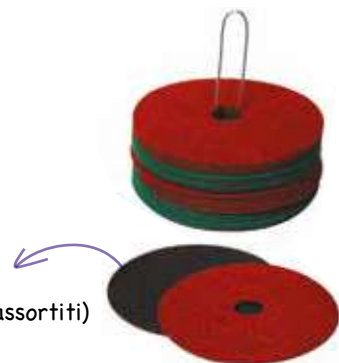

04691

texture domino (in legno)



+3
ANNI

28
PEZZI



I vari materiali di cui è composto questo gioco (tessuto, moquette, juta ecc.) danno origine a sensazioni tattili che stimolano la percezione e la capacità di riconoscimento. Promuove lo sviluppo tattile e il riconoscimento dei colori.

04730

tombola del tatto (in legno)



+3
ANNI

13
PEZZI



Il gioco è composto da un tabellone (cm.35x25) con 6 sagome di mano sinistra, ognuna in un materiale diverso e da 6 tessere (cm.11,5x11,5) su ognuna delle quali è rappresentata una mano destra. L'insegnante nasconde una tessera nella busta, dove il bambino deve infilare la sua mano e, toccando la tessera, descriverne le caratteristiche. Con l'altra mano può toccare le figure sul tabellone fino a individuare quella corrispondente. Il contenitore in legno include anche 6 buste di plastica.



10853

gioco del tatto (in legno)



CM.27x14



10852

gioco del tatto (in legno/plastica)



CM.27x14



06934

gioco del tatto (in legno)



CM.27,5x11x4



06968

gioco del tatto (in plastica)



CM.10x42



disco
Ø cm.10



08353

"Memory del tatto" (in valigetta)
contiene: 20 grandi bottoni Ø cm.6
(in 10 differenti materiali) + 2 sacchetti



Ø CM.6



Nel set è incluso un sacchetto per nascondere i bottoni; il bambino dovrà infilare una mano nel sacchettino, estrarre un bottone e cercare di trovare un altro bottone uguale al primo semplicemente toccando quelli che sono ancora nel sacchetto.



bottone
Ø cm.6

Giochi sensoriali

04779

gioco delle carezze (in legno)



Stimola lo sviluppo tattile e potenzia la memoria:
 1) il bambino, a occhi bendati, deve riconoscere il materiale che viene a contatto con la sua mano e deve cercare di descriverne le caratteristiche (caldo, freddo, liscio, ruvido...);
 2) lo stesso gioco può essere eseguito mettendo i materiali a contatto con il viso del bambino;
 3) utilizzando due sussidi il bambino può confrontare i vari materiali e riconoscere quelli uguali tra loro.



56828

gioco tattile "memoria dei cuscini" (sacco in cotone)



Il bambino deve individuare i due cuscini con la stessa imbottitura solo toccandoli. Gioco istruttivo e divertente!



59009

gioco tattile "memoria delle forme" (sacco in cotone)



È l'anatra o l'albero? Sentire e indovinare le forme nella borsa di cotone non è così facile come potrebbe sembrare!

Tavole termiche

Gioco sensoriale montessoriano, ideato per sviluppare nel bambino il senso termico e tattile. Il gioco si compone di una scatola di legno contenente 4 paia di tavolette di diversi materiali che conducono il calore in modi differenti: legno, ferro, ceramica, moquette. Il bambino dovrà abbinare le tessere uguali ed elaborare paragoni/differenze: più caldo/meno caldo, più freddo/meno freddo ecc.

Misura della tavoletta: cm. 12,5x6,5

Misura della scatola: cm. 13,2x11,7x6,7



NOVITA'

12877

8 tavole termiche cm. 12,5x6,5



342 Prime esperienze di gioco

Giochi sensoriali

Questi giochi incoraggiano i più piccoli a esplorare attraverso la vista e il tatto. Chi c'è nella scena? Solleva il tassello o apri la porta per vedere cosa si nasconde dietro! Sviluppano il vocabolario e incoraggiano la narrazione. Ottimi per lo sviluppo sensoriale e la coordinazione occhio/mano grazie ai diversi materiali utilizzati (soffice, ruvido, peloso...)



T0023

puzzle tattile "animali della fattoria" (in legno)

T0025

puzzle tattile "animali del safari" (in legno)



T0023

Manto degli animali in morbido pelo!



T0025



MAXI
FORMATO

BJ036

tavola sensoriale "in campeggio" (in legno)



BJ037

tavola sensoriale "nella giungla" (in legno)



BJ038

tavola sensoriale "nella fattoria" (in legno)



Manto degli animali in morbido pelo!





04747

domino dei sensi (in legno)

CM.7,5x15,5
(TESSERA)

+3
ANNI

20
PEZZI



Il domino è composto da 20 maxi tessere sulle quali sono raffigurati uno dei sensi e un'immagine relativa a un altro senso (es. udito/torta)

Il bambino dovrà abbinare le tessere in modo tale da associare ad ogni immagine il corrispettivo senso.



04741

tombola sonora (in legno)

CM.15x21

+3
ANNI

4
PEZZI

1
CD



04744

lotto sonoro "l'uomo e l'ambiente" (in legno)

CM.28x39

+3
ANNI

4
PEZZI

1
CD



04742

guarda e ascolta (in legno)

CM.18x37

+3
ANNI

25
PEZZI

1
CD





56683

memory dei suoni (in legno)



+3
ANNI

12
PEZZI



Individua i due blocchi sonori con lo stesso suono!
Controlla se hai indovinato guardando la stampa sottostante!



05758

cilindri sonori (in legno)

2 scatole dei suoni con 6 cilindri ciascuna



+3
ANNI

14
PEZZI



Set è composto da due scatole in legno, una con il coperchio blu e l'altra con il coperchio rosso. Ognuno dei sei cilindri in legno contenuti in ogni scatola contiene un materiale diverso. Il bambino dovrà ascoltare il suono di un cilindro "rosso" e trovare il suono gemello fra i cilindri "blu".



08887

campanelle delle melodie



+3
ANNI

8
PEZZI



Campanelle con impugnatura colorata (ogni colore corrisponde a una nota, per facilitarne il riconoscimento) intonate sulla scala di DO. Indicate per affinare le abilità di riconoscimento uditivo e per l'educazione musicale.

Piano luminoso cambiacolore

Il piano luminoso cambiacolore (12 luci LED multicolore regolabili con l'apposito telecomando) è una lavagna bianca, opaca, che ha una base in legno con bordi arrotondati per la massima sicurezza. Robusto, trasportabile e facilmente lavabile, il PIANO LUMINOSO può essere retro-illuminato collegandolo a una normale presa elettrica attraverso un cavo con trasformatore a basso voltaggio in dotazione (in conformità con le normative europee sulla sicurezza) consentendo di sperimentare effetti di luci e colori grazie all'ausilio di fogli di acetato e palette cromatiche.

12555

piano luminoso (in legno) e telecomando



CM.62x42x7



12556

vassoio (in plastica)

Appoggiando il vassoio sul piano luminoso è possibile creare giochi di forme e pregrafismi con l'uso di sabbia, perline ecc.



CM.58x39x1,5



12480

carrello (in legno)

Perfettamente adattabile al piano luminoso. Completo di ruote e due ripiani per riporre i materiali.



CM.46x73x78



CARRELLO + VASSOIO = CARRELLO PER SABBIA



DISEGNARE CON LA SABBIA

Appoggiando sul piano luminoso il vassoio (art.12556) e versandoci sopra la sabbia (art. 06821) è possibile creare una specie di "tela" sulla quale i bambini "dipingeranno" semplicemente spostando la sabbia con le dita o con le spatoline.

06820

Set "Zanzibar"

contiene:

- 1 vassoio cm.43,5x30 (manici compresi)
- 1 spatola cm.27x5
- 3 spatole pettine
- 1 spatola per scrivere
- 2 kg. sabbia bianca

+3 ANNI

7 PEZZI



06821

sacchetto da kg.2 cad. sabbia bianca finissima "Zanzibar"

12566x6

6 spatole in legno cm.25x6



Effetti cromatici



08921

set 6 fogli ADESIVI cm.21x29,7
rimovibili per vetro
Consentono di ottenere effetti di luce
grazie alla trasparenza dei fogli.
Fogli: 2 cyan, 2 magenta, 2 gialli

4 diversi strumenti che aiutano il bambino ad imparare i concetti di quadricromia, colori primari e secondari ecc. tramite divertenti effetti di luce e trasparenze.



03635

set 6 palette cromatiche
Assortite in tre colori primari e tre secondari, hanno alla base del manico un foro che ne consente la perfetta sovrapposizione.



12020

set 7 cerchi colorati \varnothing cm.8
semi-trasparenti sovrapponibili

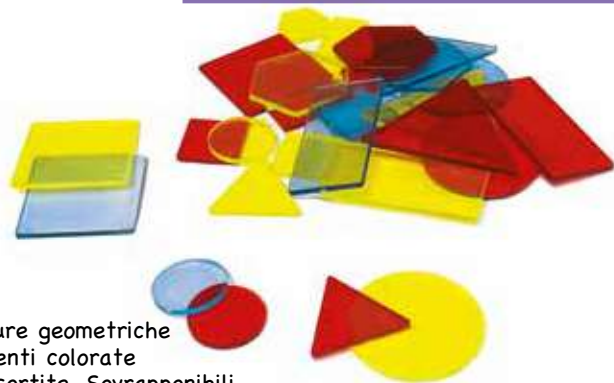

12518

busta 30 figure geometriche
semi-trasparenti colorate
dimensioni assortite. Sovrapponibili.

Forme sensoriali



16
PEZZI
cm.3x14x12

33033

set 16 forme geometriche sensoriali (in legno)

Forme e materiali differenti aiutano a sviluppare la destrezza dei bambini mentre imparano a distinguere tra le diverse sensazioni toccando e sentendo. Ottimo per sviluppare la coordinazione occhio-mano, costruire e impilare ogni forma e lasciare che la luce penetri per un bellissimo effetto di luce!



16
PEZZI
cm.3x14x12

33034

set 16 forme geometriche sensoriali arcobaleno (in legno)

La varietà di forme aiuta a creare giochi sempre nuovi, soprattutto se usate vicino a una finestra per esplorare ombre e colori mentre la luce passa attraverso ogni forma. Ogni forma contiene piccole perline colorate che stimolano occhi e orecchie.

Prime costruzioni



BB095

"Primi blocchi" (in legno)



+1 ANNI

16 PEZZI



Parallelepipedi in legno, facili da incastrare per realizzare varie forme tridimensionali.



58669

costruzioni colorate (in legno)



+3 ANNI

100 PEZZI

08876

parallelepipedi a incastro (in legno)



+3 ANNI

43 PEZZI



33035

set costruzioni "archi e triangoli" (in legno)



+3 ANNI

37 PEZZI



33036

set costruzioni "parallelepipedi" (in legno)



+3 ANNI

21 PEZZI



Viti e bulloni

pag.652
bauletti trasparenti



12343

viti e bulloni (in plastica)



+3
ANNI

48
PEZZI

CM.26x18,5x13,5
BAULETTO

cm.4,5x4,5x1,5

cm.4x6,5



Ideali per bambini che hanno già sviluppato la capacità di utilizzare le proprie mani in modo differenziato. I bambini possono avvitare e svitare i bulloni o cercare di abbinarli alle viti di forma e colore diverso, seguendo le sequenze suggerite dall'insegnante.

Catene didattiche

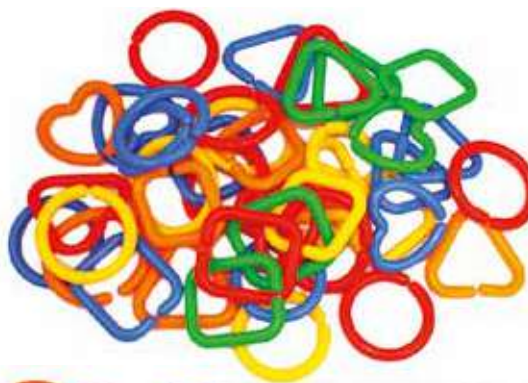

cm.7



cm.5,5

2401

catene didattiche colorate (in plastica)



+3
ANNI

500
PEZZI

CM.4

2400

catene didattiche colorate (in plastica)



+3
ANNI

170
PEZZI

CM.7

12332

catena della geometria
(in plastica)



+3
ANNI

55
PEZZI

CM.21x15,5x11,5
BAULETTO



! Strumenti didattici indicati per introdurre concetti come misurazione, classificazione, sequenza.

09939

anelli didattici (in plastica)



+3
ANNI

24
PEZZI

Ø CM.7

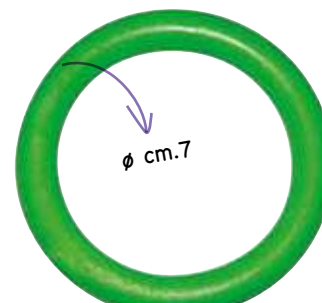

∅ cm.7

Funghi



12326

funghi colorati (in plastica)



+3 ANNI

60 PEZZI

Stecche



05818

stecche a incastro (in plastica)



+3 ANNI

72 PEZZI

Omini



12346

omini acrobatici assortiti (in plastica)



+3 ANNI

100 PEZZI



Incastri

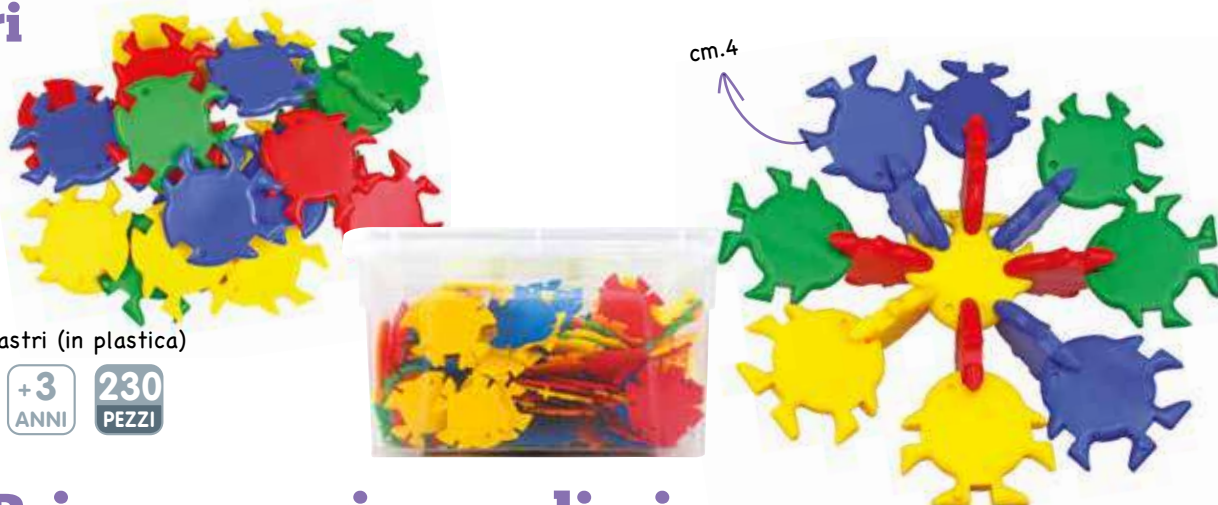

12333

oceano degli incastri (in plastica)



+3 ANNI

230 PEZZI

cm. 4

350 Prime esperienze di gioco

Costruzioni

12328/1

"IN-STAR" costruzioni (in plastica)



+3
ANNI

100
PEZZI

12328/2

"IN-STAR" costruzioni (in plastica)



+3
ANNI

220
PEZZI

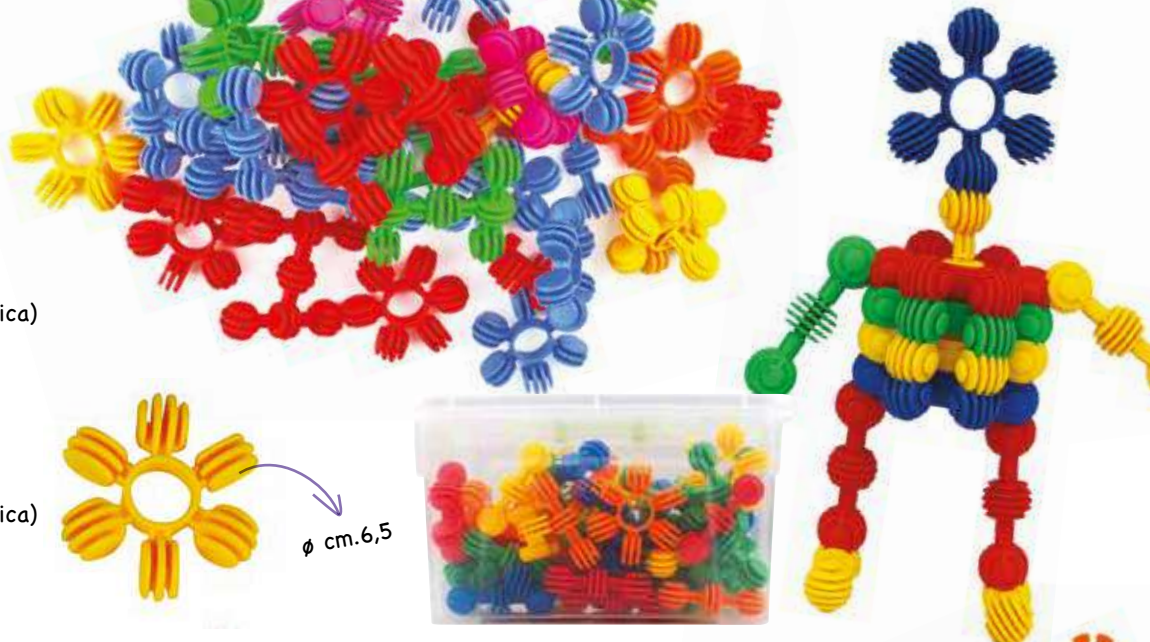

Fiorincastrì



12344

fiorincastrì **piccoli** (in plastica)



+3
ANNI

420
PEZZI



12345

fiorincastrì **grandi** (in plastica)



+3
ANNI

390
PEZZI



04782

fiorincastrì **piccoli** (in plastica)
con accessori



+3
ANNI

180
PEZZI



Motrigioco colorato

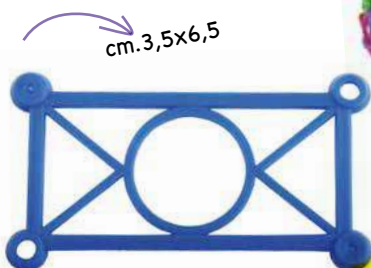

12327

motrigioco colorato (in plastica)



+3
ANNI

180
PEZZI



! Tessere a incastro realizzate con un materiale manipolativo indistruttibile. Indicate per sviluppare la sensibilità cromatica e creativa del bambino.



Modulix

12330/1

"MODULIX" costruzioni (in plastica)



+3
ANNI

100
PEZZI



cm. 4,5x8



12330/2

"MODULIX" costruzioni (in plastica)



+3
ANNI

220
PEZZI



Quadretti CLICK



cm. 5x5

12341

quadretti CLICK (in plastica)



+3
ANNI

120
PEZZI



Glisso

J401

gioco degli ingranaggi "SUPER GLISSO"
(in plastica) forme e colori assortiti

+3
ANNI

140
PEZZI



ruota blu:
ø cm. 8 x 3



Contiene un
libretto di istruzioni
per costruire
simpatici oggetti!

352 Prime esperienze di gioco

Geo-magnetica

contiene
12 triangoli
8 quadrati
8 carte

12357

geo-magnetica (in ABS di qualità)



+3
ANNI

28
PEZZI



Esplora e sperimenta queste due forme geometriche, il quadrato e il triangolo per creare modelli 3D semplici o complessi. Senti la forza magnetica e goditi infinite ore di esplorazione divertente.



06917

incastri (in plastica)



+1
ANNI

36
PEZZI



07315

"scivola e vai" (in plastica)



+1
ANNI

24
PEZZI



● **07317**

giochi magnetici (in plastica)



+1
ANNI

19
PEZZI

Cubetti multincastro

12347

cubetti multincastro (in plastica)



+3
MESI

130
PEZZI

Cubetti a incastro in materiale acrilico. Possono essere utilizzati come semplici costruzioni e come giochi matematici, con lo scopo di insegnare al bambino a contare, a costruire forme tridimensionali, a classificare gli oggetti in base al colore.





12338

tubetti colorati (in plastica)



+3
ANNI

72
PEZZI

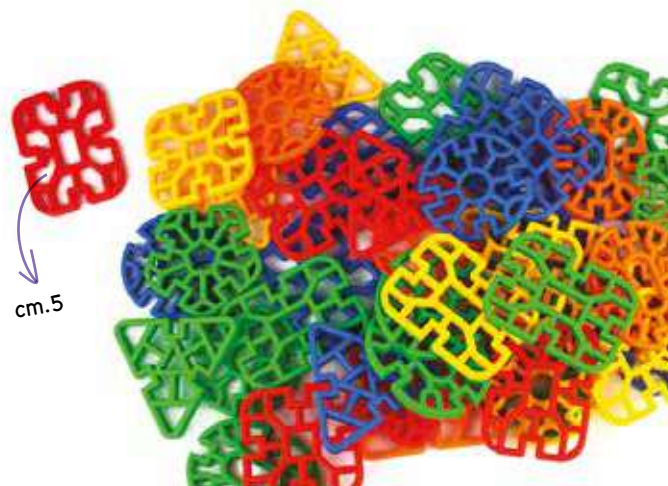

12342

trametti (in plastica)



+3
ANNI

100
PEZZI

Avvitare e Manipolare!

Questo kit contiene attrezzi, viti colorate, bulloni, rotelle, blocchi e tavole; tutto può essere unito per costruire anche le creazioni più complesse. Usando gli strumenti inclusi nel set, i bambini possono creare una grande varietà di costruzioni diverse. Il set include anche un libretto con qualche esempio per iniziare. I pezzi sono contenuti in un pratico secchiello.



91
PEZZI



T0062

costruzioni (in legno)

+3
ANNI

91
PEZZI

Preso facile per i più piccoli!



BJ688

cassetta degli attrezzi (in legno)

CM.23

+3
ANNI

18
PEZZI



NOVITA'

BJ311

cintura del carpentiere (in legno)

CM.60X16

10
PEZZI

Cintura porta-attrezzi con clip, regolabile in larghezza. Aiuta a sviluppare la destrezza e la coordinazione e incoraggia sessioni di gioco di ruolo.

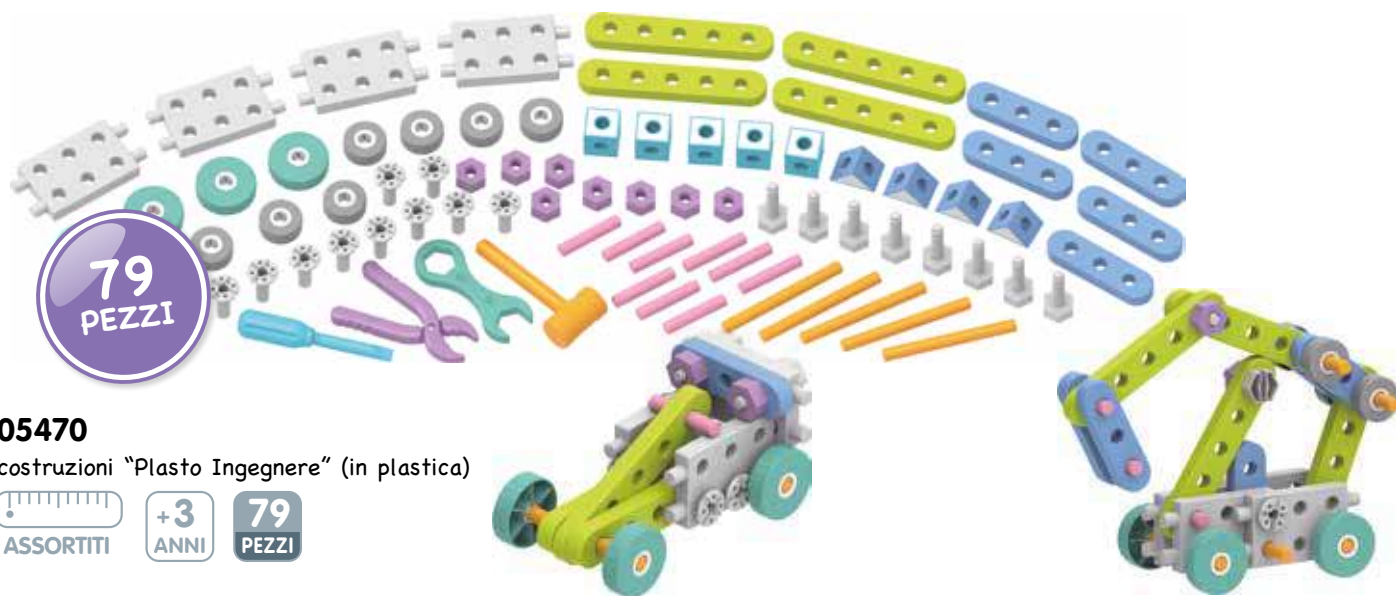

79
PEZZI

05470

costruzioni "Plasto Ingegnere" (in plastica)

ASSORTITI

+3
ANNI

79
PEZZI

Costruzioni "MICRO"



I mattoncini "MICRO" sono compatibili con i mattoncini di tutte le marche più diffuse!!!

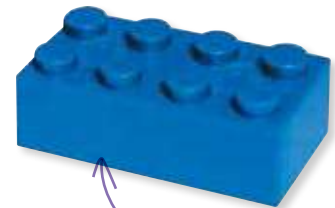

in ABS
resistente e lucido

cm.3x1,5x1,2 h

12334/1

costruzioni MICRO assortite



CM.21x15,5x11,5
BAULETTO

+ 4
ANNI

350
PEZZI

12334/2

costruzioni MICRO assortite



CM.26x18,5x13,5
BAULETTO

+ 4
ANNI

580
PEZZI

12334/3

costruzioni MICRO assortite



CM.38x27x16,5
BAULETTO

+ 4
ANNI

1600
PEZZI

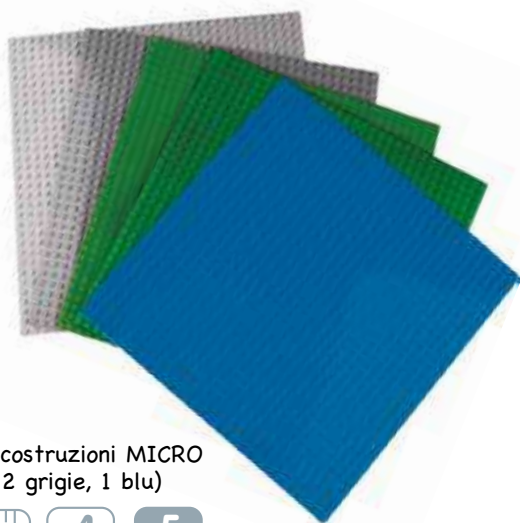

12337

basi per costruzioni MICRO
(2 verdi, 2 grigie, 1 blu)



CM.25x25

+ 4
ANNI

5
PEZZI



356 Prime esperienze di gioco

Costruzioni "MIDI"



12353/1

costruzioni MIDI assortite



+18
MESI

70
PEZZI

12353/2

costruzioni MIDI assortite



+18
MESI

220
PEZZI

12353/3

costruzioni MIDI assortite
con accessori (in plastica)



+18
MESI

188
PEZZI



I mattoncini "MIDI"
sono compatibili con i mattoncini
di tutte le marche più diffuse!!!



in **ABS**
resistente e lucido

cm.3x3x2,5 h

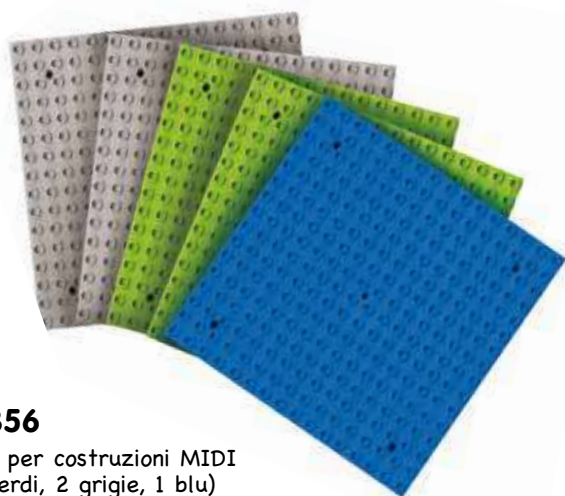

12356

basi per costruzioni MIDI
(2 verdi, 2 grigie, 1 blu)



+18
MESI

5
PEZZI



Costruzioni morbide in EVA

12432

blocchi morbidi assortiti
(in EVA)



+ 1
ANNI

30
PEZZI

09768

MAXI blocchi morbidi assortiti
(in EVA)



+ 1
ANNI

48
PEZZI

Forme per costruzioni in morbida EVA. Il modo più incredibile e divertente per creare, inventare, costruire, giocare "in grande", in totale sicurezza! Il set include pezzi assortiti in varie forme e nei 4 colori primari.

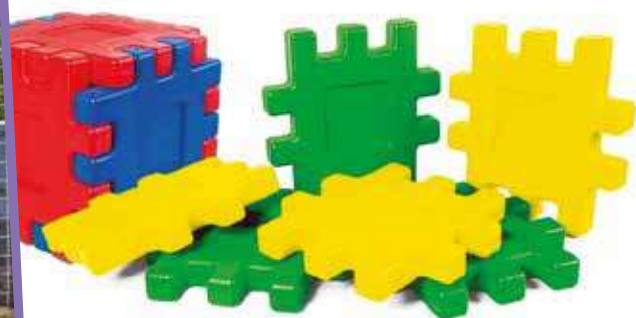

Gioco a incastro

08943

gioco a incastro colori assortiti
(in plastica)



+ 1
ANNI

12
PEZZI

Grandi elementi quadrati permettono di costruire cubi o altre costruzioni più complesse.

MAXI Costruzioni

Maxi costruzioni adatte anche ai bambini più piccoli per sviluppare la coordinazione motoria e affinare i movimenti degli arti superiori. 40 coloratissimi maxi mattoni assortiti in 4 differenti formati e colori.

10200

MAXI costruzioni assortite (in plastica)



+ 1 ANNI

40 PEZZI

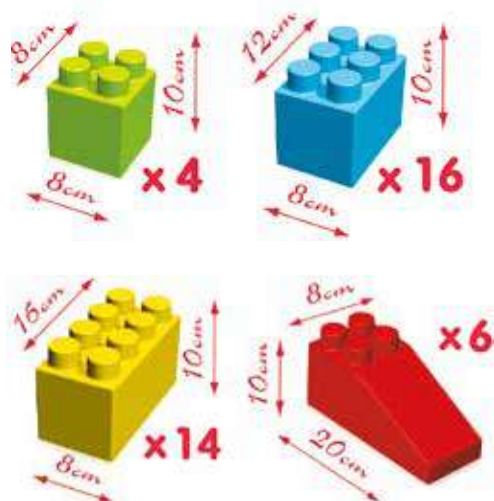

MAXI Mattoni

08942

MAXI mattoni colori assortiti (in plastica)



+ 1 ANNI

48 PEZZI



mattone verde
cm.24x12x7



Mattoni

Facili da incastrare e combinare per realizzare costruzioni e percorsi motori. È possibile riempirli con acqua o sabbia, utilizzando poi gli appositi tappi (art.04788).



10217

mattoni colori assortiti
(in plastica)

CM.24x12x6 + 1 ANNI 4 PEZZI

04785

mattoni colori assortiti
(in plastica)

CM.24x12x6 + 1 ANNI 24 PEZZI

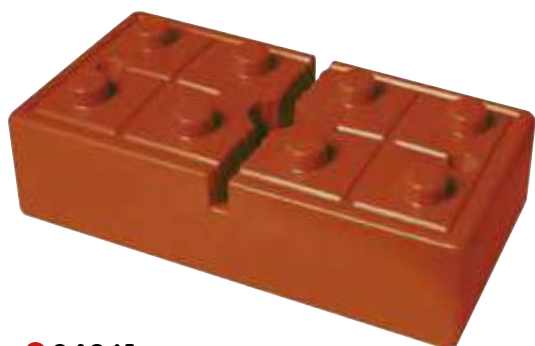

● **04961**

mattoni colore rosso scuro tipo mattone
(in plastica)

CM.24x12x6 + 1 ANNI 24 PEZZI

RESISTENTI E LEGGERI!



04788

tappi per mattoni
(in plastica)

ASSORTITI + 1 ANNI 48 PEZZI



Indicati per percorsi motori con cerchi e bastoni

I tappi hanno una duplice funzione:

- 1) antiscivolo, nel caso in cui il mattone venga utilizzato come base su cui i bambini devono esercitarsi;
- 2) se i mattoni vengono utilizzati come base per i segnali stradali, devono essere riempiti d'acqua o di sabbia. Per evitare la fuoriuscita del materiale, basterà applicare i tappi sui fori laterali.



cm.5x10

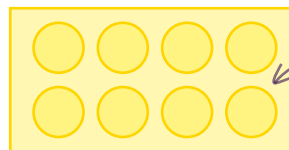

**in materiale
morbido
antirumore**

06429

MAXI costruzioni (in plastica morbida)



+18
MESI

105
PEZZI

06430

MAXI costruzioni (in plastica morbida)



+18
MESI

230
PEZZI

Un gioco tradizionale, riproposto in una versione morbida composta da maxi mattoni con cui costruire... in grande!

**Maxi
costruzioni**



07301

MAXI costruzioni (in plastica)



+1
ANNI

100
PEZZI

I mattoncini della linea MAXI, robusti e colorati, sono stati ideati per attirare l'interesse anche dei bambini più piccoli, in quanto non richiedono particolari abilità e assicurano tanto divertimento!



Mattoni in cartone

I mattoni BLOCK, prodotti in cartone pesante, sono facili da assemblare e molto resistenti: il bambino può persino saltarci sopra, senza che essi subiscano danni. Grazie a questi mattoni, grandi e leggeri, il bambino può realizzare grandi costruzioni.

NOVITA'

12946
mattone cm.15x7,5x7,5



NOVITA'

12947
mattone cm.15x15x7,5



F102x20
20 mattoni cm.30x15x7



FACILI DA MONTARE!

mattoni da assemblare
(in cartone pesante)



362 Prime esperienze di gioco

Primi trenini



BJT010

kit il mio primo trenino (in legno)



CM.44



Educativo e creativo, questo Primo trenino in legno aprirà le giovani menti ad un mondo infinito di avventure. Comprende otto pezzi di pista, un trenino e sette oggetti aggiuntivi per creare una scena di viaggio. Ulteriori accessori sono disponibili per espandere questo set.

Pista dei treni "la mia città"

Casa in legno, automobili, gente di campagna oltre a un passaggio a livello e una barca intratterranno i bambini con infiniti scenari di gioco. Ulteriori accessori sono disponibili per espandere questo set.

BJT015

kit treno, città e campagna (in legno)



CM.102x76



Pista dei treni "la forma dell'8"



STRADE
E BINARI
COLLEGABILI
TRA LORO

BJT012

kit trenino con binario a forma di "8" (in legno)

CM.102x46

+3
ANNI

40
PEZZI

Questo circuito tradizionale e sempre nuovo offre molteplici possibilità di gioco. Nella confezione oltre al circuito sono inclusi un trenino, casette, personaggi, automobili, cartelli stradali e alberi per un totale di 40 pezzi in legno. Sono disponibili anche altri accessori per espandere questo set.



Pista dei treni "i pompieri"



BJT037

trenino dei pompieri con binari (in legno)

CM.97x54

+3
ANNI

39
PEZZI

Se c'è un incendio da domare o un gattino da salvare, i piccoli pompieri possono andare a risolvere l'emergenza utilizzando questo trenino con vagoni rimovibili attraversando il tunnel nella stazione dei pompieri e rispettando i segnali stradali. Giunti sul luogo, i due pompieri potranno usare la scala di emergenza e l'idrante.



Pista dei treni "la fattoria"

Nuove storie e giochi creativi con il treno della fattoria! I bambini possono guidare il treno agricolo attraverso i frutteti e aiutare l'agricoltore a consegnare le balle di fieno, per poi fermarsi a riposare vicino al laghetto delle anatre. Altri accessori sono disponibili per espandere questo set.



BJT036

Kit trenino della fattoria (in legno)



+3
ANNI

44
PEZZI

La Stazione Centrale



BJT272

set "La stazione centrale" (in legno)



+3
ANNI

9
PEZZI

La Stazione Centrale ha tutto ciò che serve; 4 piattaforme con passerelle coperte, parcheggio multipiano ed elicottero con ascensore, tabellone delle partenze. Il set include 2 auto ed elicottero.



Tavolo da gioco con trenino e binari!



**Tavolo
con gambe!**



STRADE
E BINARI
COLLEGABILI
TRA LORO

BJT040

tavolo da gioco trenino e binari (in legno)



+3
ANNI

59
PEZZI

Il piano di gioco rialzato permette a più bambini di essere coinvolti nella sessione di gioco, rendendo facilmente accessibile ogni punto. Il set include binari in legno, un treno con vagoni dai colori vivaci, rete stradale con ponte, laghetto, barche ed eliporto con elicottero, per un totale di 59 pezzi. Il tavolo viene fornito smontato, con le istruzioni per il montaggio. Sono disponibili anche altri accessori per espandere questo set.

Binari di espansione per trenini



BJT052

set curve, rettilinei e intersezioni (in legno)



+3
ANNI

25
PEZZI

BJT057

set curve e rettilinei (in legno)



+3
ANNI

24
PEZZI

366 Prime esperienze di gioco

Ponte in legno

L'aggiunta di uno o più ponti contribuisce a creare circuiti sempre nuovi ed eccitanti.



BJT136

ponte a doppia sospensione (in legno)



CM.108x20

+3
ANNI

7
PEZZI

BJT139

ponte roccioso (in legno)



CM.22

+3
ANNI

12
PEZZI

Questo ponte sospeso tra le rocce viene fornito con binari e traliccio elettrico.



BJT120

tunnel per trenini (in legno)



CM.10x10x10

+3
ANNI



BJT247

tunnel per trenini "Mulino a vento" (in legno)



CM.13x16x22

+3
ANNI

Treni

● **55978**

trenino con vagoni magnetici (in legno)



BJT421

trenino con vagoni magnetici (in legno)



BJT180

trenino per frutta e verdura con vagoni magnetici (in legno)



BJT461

pendolino treni Virgin con vagoni magnetici (in legno)



BJT797 autotreno + 4 macchinine (in legno)



Accessori in legno per auto/trenini

BJT054

accessori per auto/trenini (in legno)



Ogni sessione di gioco diventa unica e divertente grazie a questo set di accessori. Tanti personaggi, animali, veicoli, case, alberi e anche un laghetto per ambientare tante storie diverse che girano attorno a un trenino e ai suoi binari!



368 Prime esperienze di gioco

Gru e mezzi di lavoro

BJT200

gru e mezzi di lavoro (in legno)



+3 ANNI

13 PEZZI

La gru in legno può sollevare un carico, girare intorno e anche spostarsi in avanti e indietro. Gli operai di cantiere e i loro veicoli sono a disposizione per portare a termine ogni lavoro!



Mezzi da lavoro

Il set include 5 veicoli da lavoro in legno: camion con cassone ribaltabile, gru, ruspa, escavatrice e rullo compressore. Compatibili con piste ferroviarie e set trasporti Bigjigs.



NOVITA'

BJT065

mezzi da lavoro (in legno)
5 pezzi

Garage delle auto

Garage a tre piani in robustissima plastica colorata. Completo di rampa di accesso, ascensore, autolavaggio, pompe di benzina... Nella confezione sono incluse anche tre automobili.

50400

garage completo di accessori (in plastica)



+3 ANNI

+3
AUTOMOBILINE



Parcheggio delle auto

C'è un sacco di azione ad ogni livello in questo garage, dove un ascensore funzionante porta le auto fino ai parcheggi. Un centro servizi, un autolavaggio e una pompa di benzina si trovano al piano terra, mentre una rampa di discesa fornisce ai veicoli un'uscita rapida quando è il momento di andare a casa.

JT153

parcheggio delle auto (in legno)

CM.45x37x45

+3
ANNI



- Caratteristiche:
- ascensore da lavoro
 - eliporto
 - pompa di benzina rimovibile
 - autolavaggio
 - 2 livelli di parcheggio
 - rampa di sollevamento

Città dei trasporti

Maxi set composto da 125 pezzi in legno con cui i bambini potranno creare infiniti scenari in cui ambientare storie fantastiche, mai uguali. La città dei trasporti include: binari ferroviari con ponte e stazione di lavaggio treni, aeroporto ed eliporto, stazione di servizio, ormeggio barche, ospedale, caserma dei pompieri... Il tutto corredato da personaggi, veicoli, segnali stradali, alberi e tutto ciò che serve per giocare ore e ore.

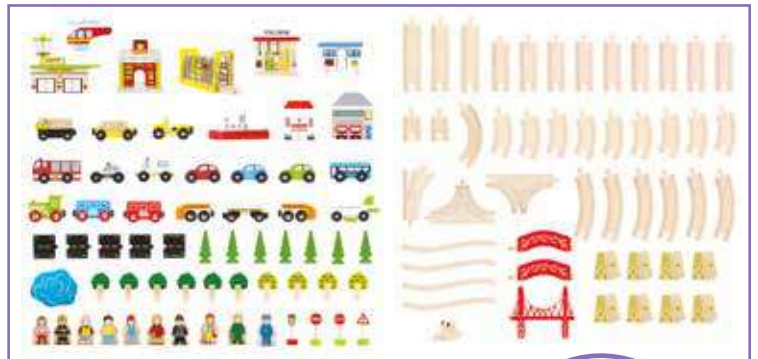

NOVITA'

BJT018

Città dei trasporti (in legno) completa di 125 pezzi

CM.115x72x17,5

+3
ANNI

125
PEZZI



370 Prime esperienze di gioco

Circuiti stradali



STRADE
E BINARI
COLLEGABILI
TRA LORO

BJT031

strada con percorso a forma di "8" (in legno)

CM.85x44

+3
ANNI

37
PEZZI

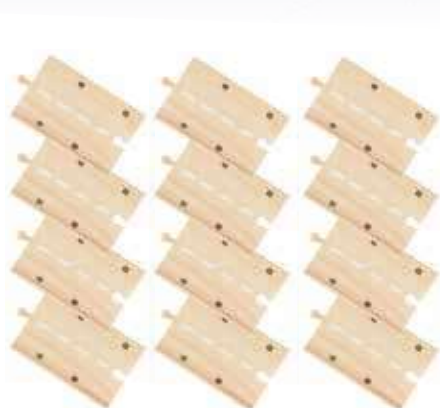

● **BJT140**

set di espansione: strada lunga
(in legno)

CM.14,5

+3
ANNI

12
PEZZI

● **BJT141**

set di espansione: strada curva
(in legno)

CM.12

+3
ANNI

16
PEZZI

● **BJT058**

strisce pedonali
+ elementi assortiti (in legno)

CM.45

+3
ANNI

10
PEZZI



BJT060 veicoli (in legno)

CM.10

+3
ANNI

9
PEZZI



BJT061

set di espansione: segnali stradali (in legno)

CM.7 CIRCA

+3
ANNI

18
PEZZI

Nastri Adesivi dei percorsi

Grazie a questi originalissimi nastri adesivi i bambini potranno creare il loro personalissimo percorso di gioco!

Facile da usare: basta staccare un pezzo di nastro adesivo della lunghezza desiderata e incollarlo su una superficie liscia. Utilizzabile su pavimenti, pareti, tavoli... Una volta rimossi, questi nastri non lasciano residui e non rovinano le superfici.

RIUTILIZZABILI!!

NOVITA'

BJ422

nastro adesivo "binari ferrovia"



MT.8x5 H

+3 ANNI



NOVITA'

BJ423

nastro adesivo "strada"



MT.8x5 H

+3 ANNI



NOVITA'

BJ424

nastro adesivo "auto-aerei"



MT.8x5 H

+3 ANNI



VEICOLI SICURI, MORBIDI e DURATURI

Il design dei veicoli, dalle forme morbide, arrotondate e prive di spigoli vivi, garantisce la sicurezza dei bambini. I veicoli sono realizzati in resistentissimo materiale plastico di altissima qualità, atossico, privo di ftalati, facilmente lavabile, che garantisce una lunga durata nel tempo del prodotto. Le ruote, fissate in modo permanente all'assale in acciaio, sono prodotte in morbida gomma che rende i veicoli estremamente silenziosi, oltre ad evitare di rovinare o graffiare mobili e pavimenti. I veicoli non contengono piccole parti considerate pericolose per i bambini, sono conformi alle normative Europee di sicurezza del giocattolo (EN71) e sono pertanto adatti anche per i più piccoli (+10 mesi).

COLORATI, SICURI, RESISTENTI E IGIENICI!

Facilmente lavabili anche in lavastoviglie!



Made in Italy



www.gogotoys.weebly.com



lovely toys®

Automobiline



09000

4 auto assortite



CM.10 CIRCA



+10
MESI



4
PEZZI



VK1084/4

4 auto e veicoli "Beetle & Jeep"



CM.14 CIRCA



+10
MESI



4
PEZZI



Mezzi di lavoro

09984

4 camion con ribalta



+10
MESI

4
PEZZI



09972

4 ruspe



+10
MESI

4
PEZZI



09992

set 1 camion + 1 rimorchio



+10
MESI

2
PEZZI



09986

set 1 ruspa + 1 rimorchio



+10
MESI

2
PEZZI



10320

set 1 camion con ribalta + 1 ruspa



+10
MESI

2
PEZZI

10070

2 camion con ribalta + 2 ruspe



+10
MESI

4
PEZZI



VK1060/4

4 veicoli assortiti
(camion pompieri, ruspe, camion con rimorchio)



+10
MESI

4
PEZZI



Trenini

09996

4 locomotive colori assortiti



CM.12

+10
MESI

4
PEZZI



09999

4 vagoni colori assortiti



CM.12

+10
MESI

4
PEZZI



09997

set trenino (1 locomotiva + 1 vagone)



CM.23

+10
MESI

2
PEZZI



09998

set trenino (1 locomotiva + 2 vagoni)



CM.34

+10
MESI

3
PEZZI

Barche

09050

4 barche colori assortiti



CM.14

+10
MESI

4
PEZZI



09991

4 gommoni colori assortiti



CM.14

+10
MESI

4
PEZZI



Assortimenti



09001

secchiello con assortimento veicoli
(contiene veicoli Art. 09000)



+10
MESI

20
PEZZI

09002

secchiello con assortimento
10 veicoli e 10 imbarcazioni



+10
MESI

20
PEZZI

10116

secchiello con assortimento
(macchinine, ruspe, camion, barche e gommoni)



+10
MESI

20
PEZZI



10117

secchiello con assortimento
(macchinine, ruspe, camion, barche e gommoni)



+10
MESI

40
PEZZI



11343

confezione scuola con assortimento
(contiene veicoli Art. 09000)



+10
MESI

50
PEZZI



pag.614
mezzi giganti

Mini ospedale

Questo ospedale in legno dai colori vivaci è completo di un letto d'ospedale, una flebo medica, un cardiofrequenzimetro, un orsetto malato, un'infermiera e un medico (totale 9 pezzi).

Ideale per insegnare al bambino cosa accade in ospedale. Scatola da viaggio richiudibile.

BJ682

"Mini ospedale" (in legno)



+3
ANNI

9
PEZZI



Caserma con camion dei pompieri

La caserma si apre per mostrare i diversi locali tra cui la camerata dei pompieri e il garage per il camion; questo, dotato di scaletta rotante, insieme alla torre incendiata permetterà ai bambini di divertirsi immaginando innumerevoli avventure!

JT156

caserma con camion dei pompieri (in legno)



+3
ANNI

7
PEZZI



Include: 1 camion, 1 torre
e 1 caserma
(personaggi non inclusi)



T0117

pompieri (in legno)



+3
ANNI

4
PEZZI

Prima Fattoria

Una bellissima fattoria in legno completa di recinti, cancelli, stalla, fienile, laghetto per le anatre, scale e spazio per parcheggiare un trattore. I pannelli del tetto sono rimovibili, e consentono un facile accesso al fienile. Un ottimo modo per sviluppare abilità narrative e di coordinazione, costruire il vocabolario e incoraggiare la creatività. NOTA: gli animali e i personaggi non sono inclusi, ma sono disponibili separatamente.



JT152

la fattoria nella prateria (in legno)

CM.45x45x25

+3 ANNI

Caratteristiche:

- Scala rimovibile
- Pannelli del tetto rimovibili
- Cancelli e porte funzionanti



T0095

famiglia fattori (in legno)

ASSORTITI

+3 ANNI

4 PEZZI



T0143

animali della fattoria (in legno)

ASSORTITI

+3 ANNI

10 PEZZI



BJ684

"Mini fattoria" (in legno)

CM.23x11,5x15

+3 ANNI

16 PEZZI



Casa delle bambole

Questa casa in legno si apre per mostrare 4 camere completamente arredate, un giardino e un patio, ed è completa di 18 mobili e 4 bambole. Il cottage può essere chiuso e trasportato comodamente grazie alla maniglia posta sul tetto.

JT123

cottage delle bambole (in legno)

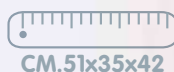

INCLUDE
4
BAMBOLE
E ARREDI

Personaggi



JT117

famiglia delle bambole cm.9 h in legno (8 pezzi)



T0125

personaggi in legno "famiglia africana" cm.11 (4 pezzi)

Casa delle Bambole

51957

casa delle bambole a 3 piani in legno (accessori e personaggi esclusi)



CM.65x35,5x86,3

+3 ANNI

Può essere arredata con gli appositi mobili, che riproducono fedelmente le varie stanze di una casa e che si adattano perfettamente alle dimensioni degli "abitanti": pupazzi con cui i bambini potranno giocare e divertirsi all'interno della casetta riproducendo attività e comportamenti della vita reale. Arredi e bambole acquistabili separatamente.

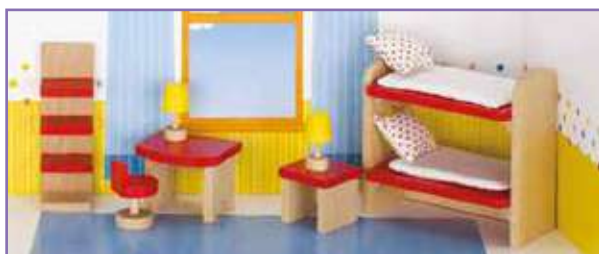

05778

cameretta (in legno)

6 PEZZI



05779

soggiorno (in legno)

10 PEZZI



05777

bagno (in legno)

5 PEZZI



05780

sala da pranzo (in legno)

9 PEZZI



05776

camera da letto (in legno)

10 PEZZI



JT116

arredamento completo (in legno)

26 PEZZI

380 Prime esperienze di gioco

Baule degli abiti



51557

baule degli abiti (in legno)



+3
ANNI

10
PEZZI



Vesti, svesti e cambia ancora. Birte e Ben adorano cambiarsi continuamente e hanno l'outfit giusto per ogni occasione. Include: 2 personaggi cm.10 h + 8 outfit completi



NOVITA'

BJ003

"Mi vesto" gioco magnetico - scatola: cm. 27x20x5

I bambini devono vestire il ragazzo e la ragazza copiando le schede incluse nel set, oppure creando originali combinazioni di abiti magnetici. Un ottimo modo per incoraggiare la narrazione e sviluppare la creatività! La scatola è parte integrante del gioco: il coperchio, infatti, è magnetico e costituisce lo sfondo su cui posizionare i personaggi del gioco.

09970

maxi tessere per casa dei giochi (in legno)



+3
ANNI

9
PEZZI

cm.70x16 h

I grandi elementi in legno possono essere incastrati tra loro in svariati modi, affinché il bambino possa costruire la casetta dei giochi o delle bambole, un recinto per i suoi animalletti, l'ambientazione per storie di fantasia.



Presepe

BJ352

presepe completo di personaggi (in legno)



+3
ANNI

16
PEZZI

Personaggi del castello

Personaggi in legno ricchissimi di dettagli, ideali per animare storie e giochi creativi di ogni tipo. Grazie agli arti pieghevoli, ogni personaggio può stare sia seduto che in posizione eretta.

NOVITA'

JT160
personaggi in legno
"famiglia reale" (4 pezzi)
cm.11 circa



NOVITA'

JT161
personaggi in legno "favole" (4 pezzi)
cm.11 circa



NOVITA'

JT162
personaggi in legno "cavalieri" (4 pezzi)
cm.11 circa



JT118
bambole in legno delle fiabe
(6 pezzi)



+3 ANNI

6 PEZZI



Personaggi in plastica



09640
fatina (in plastica)
cm.7x6,5x9,5 h



09643
mago Merlino (in plastica)
cm.7x3x10 h



09648
Re (in plastica)
cm.6,5x7,8x9,5 h



09649
Regina (in plastica)
cm.5,3x5,2x9,6 h



09644
cavaliere (in plastica)
cm.7x5x10,4h



09641
cavallo alato (in plastica)
cm.17x21,8x11 h



09642
drago (in plastica)
cm.15x13x11 h



09646
cavaliere a cavallo (in plastica)
colore rosso - 2 pezzi
cavallo cm.8x5,8x13 h



09647
cavaliere a cavallo (in plastica)
colore blu - 2 pezzi
cavallo cm.8x5,8x13 h

JT113

castello del Re (in legno)



+3
ANNI

Castello in legno da assemblare. Questo castello in legno è dotato di ponte levatoio perfettamente funzionante. C'è persino una porta segreta in modo che i cavalieri possano svignarsela senza essere visti dal nemico! Tieni fuori i nemici alzando il ponte levatoio, e rimuovi la bandiera rossa o blu a seconda di chi ha conquistato il castello.

Caratteristiche:

- ponte levatoio funzionante
- bandiere rimovibili
- porte funzionanti



WB505

costruzioni castello (in legno)



+3
ANNI

150
PEZZI



INCLUDE ANIMALI

Arca di Noè

BJ353

arca di Noè (in legno)

CM.26x33

+3 ANNI

16 PEZZI

L'ampia cabina superiore a forma di casetta può essere sollevata per dare spazio alla stiva, dove vengono alloggiati le coppie di animali. Gli animali hanno magneti sul retro e possono essere attaccati ai lati e al tetto dell'arca.



Nave dei pirati

Il gioco include: capitano, pirati, scrigno del tesoro, cannoni, barili, bandiere...

Ruote nascoste per aiutare la nave a "navigare" sul pavimento.

T0094

nave dei pirati (in legno)

CM.59x18x48

+3 ANNI

7 PEZZI

INCLUDE 6 PIRATI!



53034

animali della fattoria (in legno)

CM.2,5/11,5

+3 ANNI

14 PEZZI



53942

animali dell'Africa (in legno)

CM.3,5/7,5

+3 ANNI

20 PEZZI

384 Prime esperienze di gioco

Animali realistici



12078

dinosauri (in plastica)



+3
ANNI

8
PEZZI



12075

animali della fattoria (in plastica)



+3
ANNI

8
PEZZI



12076

animali del ghiaccio (in plastica)



+3
ANNI

6
PEZZI



12077

animali selvaggi (in plastica)



+3
ANNI

8
PEZZI



12079

insetti (in plastica)



+3
ANNI

7
PEZZI

Isola dei dinosauri

JT151

isola dei dinosauri (in legno)



INCLUDE



Torna indietro nel tempo e gioca con i dinosauri! Con questo set i bambini potranno scatenare la loro fantasia e sviluppare destrezza, immaginazione, coordinazione, vocabolario.

Caratteristiche:

- isola dei dinosauri
- 8 dinosauri
- 1 albero rimovibile
- 1 cascata



Villaggio degli indiani

Le storie migliori si raccontano davanti al fuoco, dove tamburo imita il suono della mandria di bufali. Le bambole snodabili e i loro accessori lasciano molto spazio all'immaginazione e al gioco libero!

Il set contiene: 2 capanne, 1 totem, falò, pentola, 2 bufali, 2 cavalli, 1 tamburo, 4 indiani

51911

villaggio degli indiani (in legno)



Personaggi



NOVITA'

JT160

personaggi in legno cm.11 circa
"famiglia reale" (4 pezzi)



NOVITA'

JT161

personaggi in legno cm.11 circa
"favole" (4 pezzi)



NOVITA'

JT162

personaggi in legno cm.11 circa
"cavalieri" (4 pezzi)



● **JT118**

bambole delle fiabe
in legno cm.13 (6 pezzi)



T0095

famiglia fattori in legno (4 pezzi)



T0117

pompieri in legno cm.12 (4 pezzi)



JT117

famiglia delle bambole in legno cm.9 h
(8 pezzi)



NOVITA'

T0125

personaggi in legno "famiglia africana"
cm.11 (4 pezzi)



pag.382
personaggi
in plastica



08934

personaggi "Famiglia":
mamma, papà, nonno, nonna,
2 figli adolescenti, 2 bambini



+3
ANNI

8
PEZZI



08936

personaggi "Diversamente abili"
Un'utile risorsa didattica per insegnare ai bambini
il rispetto delle diversità, e per stabilire regole
elementari di convivenza e relazione sociale.



+3
ANNI

6
PEZZI

08935

personaggi "Professioni":
pompieri, informatico,
muratore, poliziotto,
meccanico, medico,
pilota, cuoco...



+3
ANNI

11
PEZZI



dimensioni reali





Orchard Toys è un'azienda inglese leader nella produzione di giochi educativi, puzzle in cartone e album da colorare. L'azienda è nata oltre 40 anni fa, e realizzava blocchi e stencil per una scuola locale.

Oggi Orchard è un marchio riconosciuto a livello mondiale come leader nella produzione di giochi educativi e puzzle, e viene distribuito in oltre 50 paesi.

Divisione per TIPOLOGIA



Puzzle
Attività



Puzzle
per il Primo
Apprendimento



Puzzle
da Pavimento



Primi
Puzzle



Puzzle
Sagomati

Divisione per CONCETTI EDUCATIVI



Forme
e colori



Abbinamento
e memoria



Giochi
di fantasia



Socializzazione



Colori



Capacità
di ascolto



Linguaggio e
alfabetizzazione



IMPARARE DIVERTENDOSI

Tutti i giochi e puzzle Orchard Toys sono progettati pensando all'insegnamento.

Orchard Toys collabora con insegnanti, professionisti della prima infanzia e bambini per garantire che ogni prodotto raggiunga il perfetto equilibrio tra benefici educativi e divertimento!

Puzzle per il Primo Apprendimento



Puzzle progressivo "animali"

4 puzzle a tema "animali", ognuno con una difficoltà differente data dal numero di tessere (da 4 a 12).

Contenuto:
4 puzzle da 4, 6, 8, 12 tessere

● OT220

puzzle progressivo "animali"
scatola cm.19x14
puzzle cm.21x15

+3
ANNI

4-12
PEZZI

OGNI
PUZZLE



4
PUZZLE
NEL SET



Puzzle "Lo Spazio"

Puzzle da 25 pezzi ricco di dettagli che incoraggiano il dialogo e il racconto. Include anche una guida alle attività per stimolare la discussione e incoraggiare lo sviluppo dei bambini.

Contenuto:
Puzzle da 25 tessere
Guida attività (inglese)

● OT221

puzzle "lo spazio"
scatola cm.19x14 - puzzle cm.42x30

+3
ANNI

25
PEZZI



Puzzle da pavimento "Colori, numeri, animali"

Un'introduzione divertente e colorata al conteggio. Favorisce lo sviluppo della coordinazione occhio-mano e le capacità di risoluzione dei problemi. Include anche un poster gigante.

OT231

puzzle "colori, numeri, animali"
scatola cm.25x19
puzzle cm.86x29

+2
ANNI

20
PEZZI



INCLUDE
UN POSTER
GIGANTE



Giochi di Apprendimento

Memory abbinamenti

"Teste e code in fattoria"

Un gioco di abbinamento testa-piedi (o coda) molto semplice e divertente. Affina le capacità di memorizzazione e abbinamento.

Contenuto:
24 tessere
istruzioni

OT018

memory abbinamenti "teste e code in fattoria" - scatola cm.19x14



Memory abbinamenti

"Stivaletti puzzolenti"

Sviluppa le capacità di abbinamento e di osservazione. Possibilità di giocare a vari livelli di difficoltà.

Contenuto:
4 tavole da gioco
24 carte
istruzioni

OT026

memory abbinamenti "stivaletti puzzolenti" - scatola cm.19x14



Gioco di abbinamento

"Il bagnetto dei dinosauri"

Divertente gioco di calcoli e osservazione. Tre diverse modalità di gioco. Ideale per accrescere le abilità di osservazione.

Contenuto:
4 tavole da gioco
lancette dei colori/dinosauri
25 carte
istruzioni

OT051

gioco di abbinamento "il bagnetto dei dinosauri" - scatola cm.19x14



390 Prime esperienze di gioco

Tombola "Mezzi di trasporto"

Svilupa le capacità di abbinamento e memorizzazione, introducendo al bambino i temi del viaggio e degli spostamenti.

● OT094

tombola "mezzi di trasporto"
scatola cm.19x14

+2
ANNI

2-4
GIOCATORI



Domino

Svilupa le capacità di osservazione e di abbinamento in base all'animale o al colore.

Contenuto:
28 tessere domino
istruzioni

● OT006

domino della campagna
scatola cm.19x14

+3
ANNI

2-4
GIOCATORI



Impara l'inglese "Parole e numeri"

50 carte fronte/retro per aiutare i più piccoli nel primo approccio con numeri e parole in inglese. Sviluppa le prime abilità linguistiche, di lettura e di conoscenza dei numeri.

Contenuto:
50 playcards
istruzioni



OT019

impara l'inglese - playcards parole
e numeri - scatola cm.19x14

+3
ANNI

1
GIOCATORE





Memory progressivo "Cavalieri e draghi"

Un gioco di abbinamento testa-piedi molto semplice e divertente. Affina le capacità di memorizzazione, abbinamento e riconoscimento dei colori. Incoraggia il dialogo e il racconto di storie.

Contenuto:
20 carte "testa"
20 carte "piedi"
10 carte drago
6 carte castello
istruzioni



OT096

memory progressivo "cavalieri e draghi"
3 in 1 - scatola cm.19x14



Memory + gioco "Giraffe con le sciarpe"

Gioco di memoria che favorisce lo sviluppo delle capacità di abbinamento, conteggio e memorizzazione. Vince chi ha più sciarpe!

Contenuto:
6 basi gioco
6 carte "testa"
24 carte "collo"
1 dado
istruzioni



OT070

memory + gioco "giraffe con le sciarpe"
scatola cm.19x14



Impara l'inglese

Svilupa le capacità di lettura e composizione delle parole. Livello di difficoltà differenziato per chi ha appena iniziato a conoscere le lettere e per chi le sa già usare.

Contenuto:
 12 schede double-face con parole di 3 lettere
 8 schede double-face con parole di 4 lettere
 68 lettere
 istruzioni



OT004

impara l'inglese - combina e pronuncia
 scatola cm.19x14



Tombola + memory "Dove vivono?"

Gioco di memoria e tombola per imparare nozioni sugli animali e sul loro ambiente. Promuove il dialogo e sviluppa le abilità di abbinamento e memorizzazione. Le tavole gioco double face riportano informazioni sugli animali.

Contenuto:
 4 tavole da gioco double face
 28 carte
 istruzioni



OT069

tombola + memory "dove vivono?"
 scatola cm.26x22,5



Valigetta dei giochi

4 giochi nella stessa valigetta! Ideali per sviluppare abilità di abbinamento, riconoscimento dei colori e conteggio. Questo set di giochi offre varietà, divertimento e un ottimo rapporto qualità-prezzo.

Contenuto:

- Gioco della fattoria
- Domino dei mostri
- Gioco dei colori
- Scale e serpenti nella giungla



OT510

valigetta dei giochi 4 IN 1 (in cartone)
scatola cm.30,5x26

+3 ANNI

2-4 GIOCATORI



OT020

gioco puzzle "Lunch box"
da 2 a 4 giocatori (in cartone)

ASSORTITI

+3 ANNI



Incoraggia una sana alimentazione e migliora le capacità di memoria con questo gustoso gioco!

Include: 4 tavole lunchbox
24 carte oggetto, istruzioni



OT060

gioco puzzle "pizza"
da 2 a 4 giocatori (in cartone)

ASSORTITI

+3 ANNI



Include:
25 carte a forma di fetta di pizza
4 tavole per la pizza
1 doppio spinner
1 tavola di capo cuoco
1 libretto di istruzioni

Un emozionante gioco di abbinamento di forme e colori. Fai girare il doppio spinner e scegli una carta per colore o forma. Il vincitore è la prima persona a riempire il proprio tabellone della pizza, ma fai attenzione ai condimenti che devono essere gettati nel cestino! I condimenti in questo gioco sono a volte molto inusuali... i bambini lo trovano esilarante!



Tombola + memory dei colori

Tombola e gioco di memoria per insegnare i colori ai più piccoli. Sviluppa le abilità di abbinamento, osservazione e memoria.

Contenuto:
4 cartelle tombola
24 carte
istruzioni

OT044

tombola + memory dei colori
scatola cm.26x22,5



Tombola + memory della fattoria

Un gioco di memoria e abbinamento ambientato nel mondo della fattoria. Gli insegnanti possono chiedere ai bambini di fare il verso degli animali o mimare azioni quando scelgono una carta.

Contenuto:
4 tavole da gioco
28 carte
istruzioni

OT071

tombola + memory della fattoria
scatola cm.26x22,5



Forme e colori "Dinosauri"

Semplice gioco di abbinamenti di forme e colori. Tavole double face a forma di dinosauro: da una parte si gioca con i colori, dall'altra con le forme.

Contenuto:
4 tavole da gioco
24 forme
24 tondi colorati
1 dado colori
1 dado forme
shaker per dadi
istruzioni

OT062

forme e colori "dinosauri"
scatola cm.26x22,5





Giocchi di Apprendimento

Gioco suono/azioni "Sveglia il bradipo"

Un gioco divertente che permette ai più piccoli di fare rumore ed esibirsi mentre affinano le capacità di ascolto.

Contenuto:
4 tavole gioco
16 carte bradipo
32 carte attività
istruzioni

+2 ANNI

2-4 GIOCATORI



OT097

gioco suono/azioni "sveglia il bradipo"
scatola cm.19x14



La mia prima tombola dei suoni

Tombola sonora per i più piccoli, corredata di puzzle. Favorisce lo sviluppo delle capacità di ascolto e abbinamento.

Contenuto:
4 tavole gioco
24 carte
1 puzzle (pz. 6)
istruzioni



OT100

la mia prima tombola dei suoni
+ puzzle - scatola cm.19x14

+2 ANNI

2-4 GIOCATORI



Primi Puzzle

Puzzle "C'era una volta"

Sei coloratissimi puzzle composti da tre tessere, ideali per le manine dei bambini più piccoli e per affinare la coordinazione occhio-mano.

Contenuto:
6 puzzle da 3 tessere cad.



OT210

puzzle "c'era una volta"
scatola cm.19x14
puzzle cm.20x21

+2 ANNI

3 PEZZI

OGNI PUZZLE



Puzzle "Mezzi di lavoro"

Questi puzzle colorati da 4 e 8 pezzi raffigurano diversi veicoli da lavoro. Il set include anche 8 pezzi extra per incoraggiare la creatività.

Contenuto:
4 puzzle da 4 e 8 tessere
8 pezzi extra



OT201

puzzle "mezzi da lavoro"
scatola cm.19x14
puzzle cm.13x16

+3 ANNI

4&8 PEZZI

OGNI PUZZLE



396 Prime esperienze di gioco

PRIMI PUZZLE

Sei diversi puzzle formati da soli due pezzi, facili da afferrare e coloratissimi. Ideali per i bambini più piccoli, dai 18 mesi in su, per affinare la coordinazione occhio-mano.

Contenuto:
6 puzzle da 2 tessere cad.



Puzzle "Dinosauri"

Contenuto:
6 puzzle da 2 tessere cad.

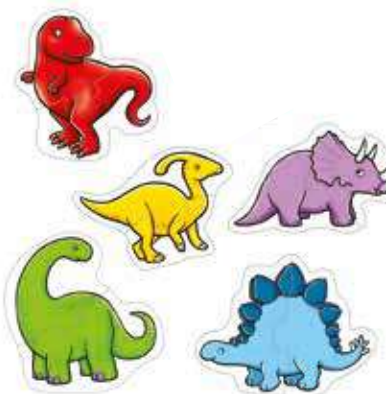

OT225 puzzle
"dinosauri"
scatola cm.19x14
puzzle cm.14x14

+18 MESI
2 PEZZI
OGNI PUZZLE

Puzzle "Mezzi di trasporto" Puzzle "Mamma e figlio"

Contenuto:
6 puzzle da 2 tessere cad.



6 PUZZLE NEL SET

OT203
puzzle "mezzi di trasporto"
scatola cm.19x14
puzzle cm.14x14

+18 MESI
2 PEZZI
OGNI PUZZLE

Contenuto:
6 puzzle da 2 tessere cad.



6 PUZZLE NEL SET

OT290
puzzle "mamma e figlio"
scatola cm.19x14
puzzle cm.13x16

+18 MESI
2 PEZZI
OGNI PUZZLE



Puzzle Attività

Puzzle "Abbina i colori"

Set di 12 puzzle autocorrettivi che incoraggiano i bambini a identificare i colori mettendoli in relazione con oggetti familiari.

Contenuto:
12 puzzle da 5 tessere cad.

OT223

puzzle "abbina i colori"
scatola cm.19x14
puzzle cm.7x27

+3
ANNI

5
PEZZI
OGNI
PUZZLE



12
PUZZLE
NEL SET



Puzzle Giganti Sagomati

Puzzle gigante "Trattore"

Grande puzzle del trattore che favorisce lo sviluppo delle capacità descrittive e di dialogo. Sul retro della scatola c'è una divertente guida, che offre diversi spunti di discussione e di attività.

Contenuto:
Puzzle da 25 tessere

OT224

puzzle "trattore"
scatola cm.25x19
puzzle cm.62x41

+3
ANNI

25
PEZZI



Puzzle gigante "Dinosauri"

Grande puzzle sagomato da 50 pezzi ricco di dettagli che incoraggiano l'osservazione, il dialogo e il gioco fantasioso. Include anche una guida alle attività.

Contenuto:
Puzzle da 50 tessere

OT256

puzzle "dinosauri"
scatola cm.25x19
puzzle cm.58x40

+4
ANNI

50
PEZZI



398 Prime esperienze di gioco

Album da colorare con attività



Album da colorare con stickers

FORMATO A4 (CM.21x29,7) 24 PAGINE

Aiutano a migliorare la destrezza manuale e incoraggiano la creatività proponendo obiettivi educativi chiari e facili da raggiungere. Gli album sono ricchi di immagini appositamente studiate per le varie fasce di età e attività step by step che aiutano a rafforzare le abilità acquisite. Ogni album contiene anche coloratissimi stickers da aggiungere a ogni pagina!



OTCB01
album "animali"

+3
ANNI



OTCB09
album "dinosauri"
(in inglese)

+3
ANNI



OTCB10
album "fattoria"
(in inglese)

+3
ANNI



OTCB11
album "giungla"
(in inglese)

+3
ANNI



OTCB12
album "lo spazio"
(in inglese)

+3
ANNI



OTCB02
album "ABC"
(in inglese)

+4
ANNI



OTCB04
album "prime parole"
(in inglese)

+4
ANNI



OTCB03
album "numeri 1/10"
(in inglese)

+4
ANNI



OTCB08
album "numeri 1/20"
(in inglese)

+4
ANNI

Flash Card

Le **FLASHCARD** sono una delle tecniche più utilizzate per lo studio e la memorizzazione dei vocaboli, ma hanno svariati impieghi nella didattica.

Ispirate al metodo Montessori, permettono di svolgere diverse attività progressive per accrescere il riconoscimento di tantissime parole. Contribuiscono allo sviluppo dell'ascolto e della comprensione. Aiutano nella dizione e nella fonetica agevolando i bambini a pronunciare correttamente le parole e memorizzarle. Riconoscere gli animali, le professioni, i mezzi di trasporto ecc...ma anche inventare favole in sequenza liberando la fantasia dei bambini. E per i più grandi aiutano ad imparare i numeri, le operazioni matematiche e i giochi di carte.

Ogni flashcard ha uno sfondo colorato brillante per attirare e coinvolgere i bambini. Queste carte sono fantastiche per aiutare i bambini a sviluppare precisione e fiducia nelle abilità. Resistenti, ideali per le classi.

+3 ANNI

52 PEZZI



CARTA:
CM.8,8x5,5



BJ431

set flash cards "Dinosauri"



BJ434

set flash cards "Famiglia"



BJ432

set flash cards "Fattoria"

INVENTA STORIE!



BJ435

set flash cards "Fantasy"



33012

set flash cards "Mezzi di trasporto"



BJ433

set flash cards "Animali selvaggi"



33022
set flash cards 1-10"



33015
set flash cards "Addizioni 1-10"



33023
set flash cards "Sottrazioni 1-10"



33016
set flash cards "Moltiplicazioni 1-6"



33017
set flash cards "Moltiplicazioni 7-12"



33018
set flash cards "Divisioni 1-10"



33007
carte da gioco illustrate



Puzzle per i più piccoli

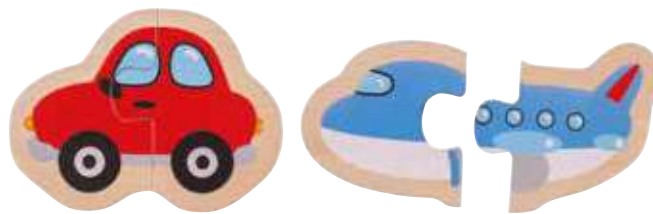
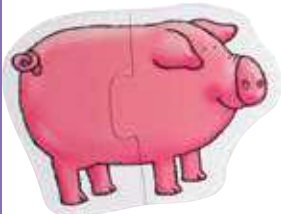
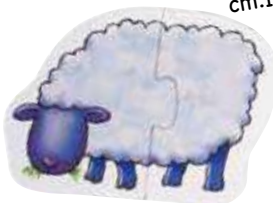

OT202

puzzle "animali della fattoria" (in cartone)
6 soggetti composti ognuno da 2 pezzi



BJ226

puzzle "trasporti" (in legno)
4 soggetti composti ognuno da 2 pezzi



BJ816

puzzle "dinosauri" (in legno)
3 soggetti composti ognuno da 6 pezzi



BJ817

puzzle "Mezzi da lavoro" (in legno)
3 soggetti composti ognuno da 6 pezzi



Puzzle alza e guarda



BB014

puzzle alza e guarda "fattoria" (in legno)



BB015

puzzle alza e guarda "safari" (in legno)



BB016

puzzle alza e guarda "animali" (in legno)



BB017

puzzle alza e guarda "giochi" (in legno)



BJ026

puzzle alza e guarda "frutta" (in legno)



cm.30x25



Giochi sensoriali

Questi giochi incoraggiano i più piccoli a esplorare attraverso la vista e il tatto. Chi c'è nella scena? Solleva il tassello o apri la porta per vedere cosa si nasconde dietro! Sviluppano il vocabolario e incoraggiano la narrazione. Ottimi per lo sviluppo sensoriale e la coordinazione occhio/mano grazie ai diversi materiali utilizzati (soffice, ruvido, peloso...)



T0023



T0025

T0023

puzzle tattile "animali della fattoria" (in legno)

T0025

puzzle tattile "animali del safari" (in legno)



BJ036

tavola sensoriale "in campeggio" (in legno)



BJ037

tavola sensoriale "nella giungla" (in legno)



BJ038

tavola sensoriale "nella fattoria" (in legno)



Puzzle "Ciclo vitale"

I puzzle a 4 strati sono uno strumento divertente ed educativo per imparare il ciclo della vita. Scoprendo i vari strati, i bambini capiranno concetti fondamentali come le fasi vitali e il trascorrere del tempo.



33029

puzzle a strati "Ciclo vitale - Coccinella"
(in legno)



+18
MESI

7
PEZZI



33030

puzzle a strati "Ciclo vitale - Farfalla"
(in legno)



+18
MESI

7
PEZZI



33032

puzzle a strati "Ciclo vitale - Ape"
(in legno)



+18
MESI

7
PEZZI



33031

puzzle a strati "Ciclo vitale - Rana"
(in legno)



+18
MESI

7
PEZZI



57897

puzzle su 4 livelli "Pesce" (in legno)



+2
ANNI

11
PEZZI



Mini puzzle



04694

mini-puzzle degli animali (in legno)



BJ509

puzzle "Il manto degli animali" (in legno)



06378

puzzle MONTESSORIANI (in legno)



Puzzle in legno antisceggia dotati di pomelli in plastica che permettono ai bambini di afferrare e riposizionare i singoli pezzi con facilità.



Matrioska

R165

set matrioska



R164

set matrioska



NOVITA'

BJ003

"Mi vesto" gioco magnetico - scatola: cm. 27x20x5

I bambini devono vestire il ragazzo e la ragazza copiando le schede incluse nel set, oppure creando originali combinazioni di abiti magnetici. Un ottimo modo per incoraggiare la narrazione e sviluppare la creatività! La scatola è parte integrante del gioco: il coperchio, infatti, è magnetico e costituisce lo sfondo su cui posizionare i personaggi del gioco.

Puzzle "I miei piccoli amici"

4 coppie di 2 piccoli amici provenienti da ogni parte del Mondo! La testa, il corpo e le gambe di ogni personaggio si sollevano, lasciando ai più piccoli il compito di rimetterli insieme - capire quale pezzo appartiene a quale personaggio! Il disegno sulla tavola può essere utilizzato come guida. Un ottimo modo per sviluppare coordinazione mano/occhio, capacità motorie e destrezza.



BJ782

puzzle "I miei piccoli amici" (in legno)



Puzzle "L'armadio degli orsetti"

La scatola contiene abiti e facce di orso con espressioni diverse, che si incastrano tra loro e si posizionano sul coperchio. Sviluppa le capacità di abbinamento e rinforza il vocabolario quotidiano. Aiuta a sviluppare destrezza e coordinamento.



BJ766

puzzle "L'armadio degli orsetti" (in legno)



Puzzle "I mestieri che ci aiutano"

Insegna ai bambini nome e divisa degli operatori di emergenza, e il ruolo che svolgono nell'aiutare le persone. Sviluppa la concentrazione e la coordinazione motoria.



BJ225

puzzle "I mestieri che ci aiutano" (in legno)



Gioco magnetico "Le professioni"

I bambini devono vestire il personaggio usando gli abiti magnetici. Ci sono 7 diversi outfit tra cui scegliere, decidendo se abbinarli correttamente o mescolare e abbinare in modo creativo. Un ottimo modo per incoraggiare la narrazione e sviluppare la creatività.



BJ011

gioco magnetico "Le professioni"



Puzzle "Gradazione e Seriazioni"

A seconda della tavola, vengono rappresentate: successioni logiche, temporali e di orientamento spaziale.



04700

puzzle "le mele" (in legno)



04701

puzzle "i pulcini" (in legno)



04704

puzzle "le 4 stagioni" - successione logico/temporale delle stagioni (in legno)



Puzzle con i pomelli



BJ257

puzzle "dinosauri" (in legno)



57874

puzzle "zoo degli animali" (in legno)



57866

puzzle "animali" (in legno)



57546

puzzle "in campagna" (in legno)



57547

puzzle "il mio viaggio" (in legno)



Puzzle con i pomelli

57907

puzzle "pompieri" (in legno)



+2 ANNI

8 PEZZI



57593

puzzle "mezzi da lavoro" (in legno)



+2 ANNI

7 PEZZI



57550

puzzle "fattoria" (in legno)



+2 ANNI

9 PEZZI



57996

puzzle "mezzi di trasporto" (in legno)



+2 ANNI

8 PEZZI



Puzzle alza e guarda con pomelloni!



BJ519

puzzle "mezzi di trasporto" (in legno)



+1 ANNI

4 PEZZI



BJ520

puzzle "fattoria" (in legno)



+1 ANNI

4 PEZZI



57929

puzzle "mamma e figlio" (in legno)



+2 ANNI

6 PEZZI



Puzzle con i pomelli



04721
puzzle "casa dolce casa" (in legno)

CM.20,5x30 +3 ANNI 7 PEZZI



04723
puzzle "colazione" (in legno)

CM.20,5x30 +3 ANNI 7 PEZZI



04724
puzzle "casa di Margherita" (in legno)

CM.20,5x30 +3 ANNI 10 PEZZI



04725
puzzle "in gita con papà" (in legno)

CM.20,5x30 +3 ANNI 7 PEZZI



07776
puzzle "animali domestici" (in legno)

CM.22,5x30 +3 ANNI 9 PEZZI

IMMAGINI REALISTICHE



04711
puzzle "alimenti" (in legno)

CM.20,5x30 +3 ANNI 11 PEZZI



04716
puzzle "animali" (in legno)

CM.20,5x30 +3 ANNI 9 PEZZI



04712
puzzle "elefanti" (in legno)

CM.20,5x30 +3 ANNI 9 PEZZI



04714
puzzle "dalmata" (in legno)

CM.20,5x30 +3 ANNI 8 PEZZI



04717
puzzle "gatti" (in legno)

CM.20,5x30 +3 ANNI 8 PEZZI



04718
puzzle "procioni" (in legno)

CM.20,5x30 +3 ANNI 9 PEZZI

Puzzle educativi



BB106

puzzle "alfabeto minuscolo" (in legno)



CM.28x28



BB055

puzzle "alfabeto maiuscolo" (in legno)



CM.28x28



BJ755

puzzle "lettere maiuscole" (in legno)



CM.30x21



BJ757

puzzle "lettere minuscole" (in legno)



CM.30x21



BJ756

puzzle "numeri" (in legno)



CM.30x21



BB032

costruzioni "ABC" (in legno)



CM.22x26,5x4,5





Soggetti magnetici

Soggetti in legno con retro magnetico, ideali per incoraggiare lo storytelling creativo. Giocando con i magneti i bambini possono incrementare il loro vocabolario e imparare a inventare storie con i soggetti magnetici. In scatola in legno.

pag.312
lavagna magnetica



BJ271

soggetti magnetici "Mille e una favola" (in legno)



+3 ANNI

35 PEZZI



BJ273

soggetti magnetici "Frutta e verdura" (in legno)



+3 ANNI

35 PEZZI



BJ274

soggetti magnetici "La fattoria" (in legno)



+3 ANNI

35 PEZZI



BJ275

soggetti magnetici "Il mondo del bosco" (in legno)



+3 ANNI

35 PEZZI





BJ001

puzzle "Magnetici piumati"



+3 ANNI

15 PEZZI



Tavole magnetiche

Grazie ai magneti, i bambini possono creare una scena diversa ad ogni sessione di gioco, dando spazio all'immaginazione. I 14 magneti in legno possono essere utilizzati sulla lavagna magnetica e persino sul frigorifero! Un ottimo modo per incoraggiare il pensiero creativo e narrativo, l'immaginazione e la coordinazione.



BJ908

tavola magnetica "Safari" (in legno)



+3 ANNI

14 PEZZI



BJ909

tavola magnetica "Fattoria" (in legno)



+3 ANNI

14 PEZZI



BJ910

tavola magnetica "Città" (in legno)



+3 ANNI

16 PEZZI





Lettere e numeri magnetici

pag.312
lavagna magnetica

Numeri e lettere in legno con retro magnetico, che si attacca alle superfici metalliche. Un gioco divertente che aiuta a sviluppare le abilità di ortografia, il riconoscimento di lettere e numeri e permette al bambino di comporre parole, messaggi, operazioni matematiche di base.

BJ264

lettere maiuscole magnetiche (in legno)



+3
ANNI

49
PEZZI

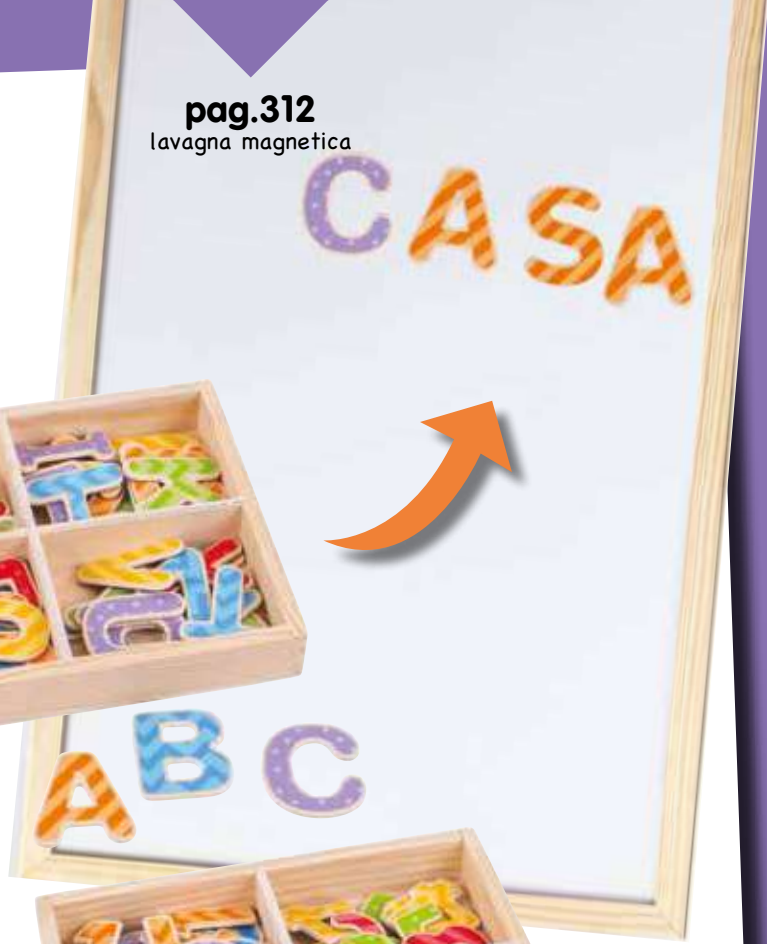

BJ265

lettere minuscole magnetiche (in legno)



+3
ANNI

63
PEZZI



BJ266

numeri magnetici + simboli (in legno)



+3
ANNI

56
PEZZI



06955

lettere magnetiche (in legno)



+3
ANNI

52
PEZZI



06956

numeri magnetici + simboli (in legno)



+3
ANNI

37
PEZZI





BJ090

lettere minuscole (in legno)



CM.9 H
LETTERA

+3
ANNI

26
PEZZI



pag.429
pregrafismi



BJ091

lettere maiuscole (in legno)



CM.9 H
LETTERA

+3
ANNI

26
PEZZI



06726/N

lettere maiuscole magnetiche (in EVA)



CM.5 H
LETTERA

+3
ANNI

67
PEZZI



Lavagna magica

Con la lavagna magica disegnare non è mai stato così facile e divertente. Con l'apposita penna si può disegnare sulla lavagna tutto ciò che si desidera, poi basta tirare la linguetta... ed è subito magia! Tutto scompare ed è pronta per essere riutilizzata infinite volte. Ideale per sviluppare la creatività del bambino.

06916

lavagna magica (in cartone)



CM.27x19

+3
ANNI



il serpente dei numeri



BJ517

puzzle "il serpente numeri" (in legno)



Imparare a contare è facile con il serpente! Ogni pezzo di legno ha un numero che è riportato anche sulla base. Il gioco è autocorrettivo, in quanto ogni pezzo può essere inserito solo nella posizione corretta. Pezzi coloratissimi, facili da afferrare e maneggiare.



il cocodrillo dei numeri

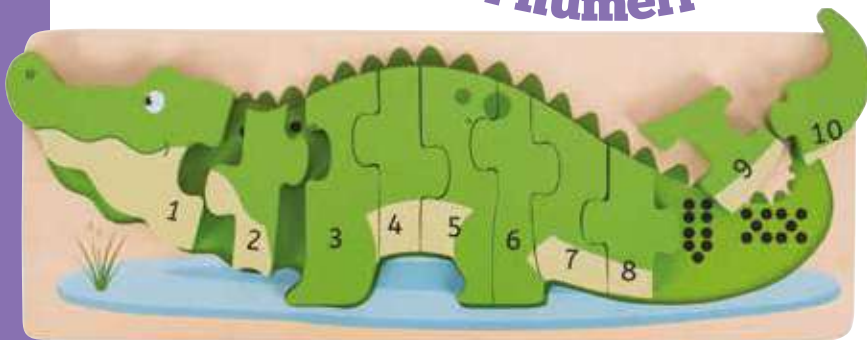

cm.45

BJ029

puzzle "il cocodrillo numeri" (in legno)



Dietro a ciascun pezzo in legno numerato sono raffigurati dei pallini neri corrispondenti al numero indicato sul pezzo. Per completare il puzzle i bambini devono abbinare il numero alla quantità di pallini raffigurati sulla tavoletta. Questo puzzle in legno presenta 10 pezzi di grandi dimensioni, facili da sollevare, afferrare, esaminare e riposizionare anche dalle manine più piccole.

Domino dei numeri

BJ261

puzzle "numeri" (in legno)

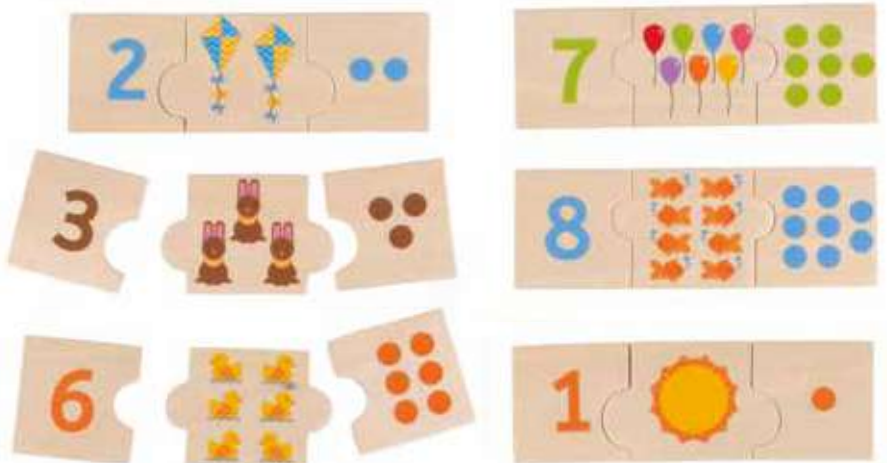

Domino delle associazioni immagini-numeri



BJ535

domino "numeri e figure" (in legno)



Puzzle-cubi

BJ798

puzzle "animali della fattoria"
(in legno)
16 cubi puzzle per comporre
6 diverse immagini



**6 DIVERTENTI
COMBINAZIONI!**



Puzzle "Le 4 stagioni"

05915

puzzle "Le quattro stagioni"
(in cartone)



I grossi pezzi di cui i puzzle sono composti stimolano le capacità logiche del bambino. I puzzle delle stagioni sono perfetti per insegnare al bambino la vasta terminologia legata al tempo, alle stagioni e agli eventi meteorologici.



cm.28x35



57684

puzzle "Le quattro stagioni" (in legno)
ogni stagione su un livello diverso



PUZZLE
SU 4
LIVELLI



cm.20x20

Puzzle "In fondo al mar"

Questo puzzle da pavimento, composto da 48 pezzi in legno, presenta una scena sottomarina dai colori vivaci. C'è molto da guardare e molto di cui parlare (scienza, biologia, ambiente...), il che rende il completamento di questo puzzle un'attività divertente genitore-figlio o insegnante-alunno.

48
PEZZI



BJ917

puzzle da pavimento "In fondo al mar" (in legno)



418 Prime esperienze di gioco

Puzzle memory



● **56904**
memory 5 animali assortiti (in legno)

CM.6,5x6,5
TESSERA

+3
ANNI

32
PEZZI



56869
memory "Animali del bosco" (in legno)

CM.5x5
TESSERA

+3
ANNI

32
PEZZI



Puzzle giganti

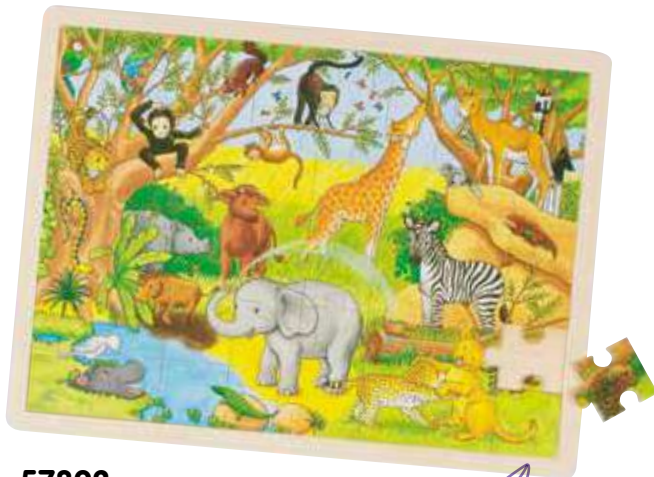

57892
puzzle "Africa" (in legno e cartone)

CM.40x30

+3
ANNI

48
PEZZI



57891
puzzle "fattoria" (in legno e cartone)

CM.30x20

+3
ANNI

24
PEZZI



57808
puzzle "visita allo zoo" (in legno e cartone)

CM.30x20

+3
ANNI

24
PEZZI

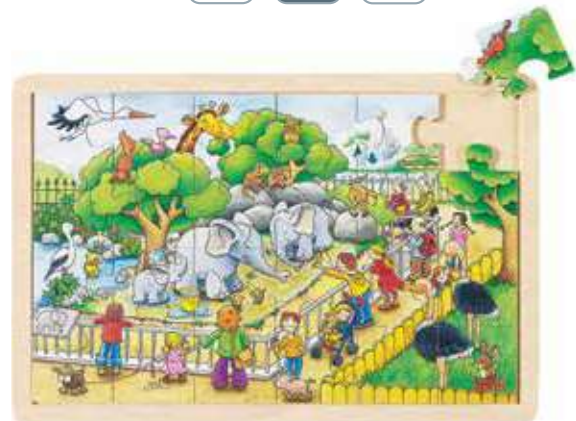

Puzzle GIGANTE



PUZZLE GIGANTI
CM.43x33



BJ742

puzzle gigante "i pompieri" (in legno)



BJ741

puzzle gigante "il treno" (in legno)



11439

puzzle "la fattoria" (in cartone)
puzzle da 30 pezzi + libretto



Cofanetto puzzle in cartone facile da assemblare, indicato per i più piccoli!

PUZZLE GIGANTE + LIBRETTO



Puzzle alza e guarda

PUZZLE SU 3 LIVELLI



BJ588

puzzle "la casa" (in legno)
alza e guarda cosa accade su ogni livello



Tre differenti strati da scoprire! Il tema è sempre quello della casa, ma ad ogni strato emerge una scena differente.

Puzzle educativi



cm.11x14

OT204

puzzle "Squadra di salvataggio" (in cartone)



+2
ANNI

22
PEZZI



cm.20x20

OT213

puzzle "Che faccio?" (in cartone)



+2
ANNI

18
PEZZI



● **11436**

puzzle "Il grande cantiere" + 1 libro (in cartone)



+2
ANNI

10
PEZZI



Impara a riconoscere le principali forme geometriche!



11437

puzzle "i grandi animali" + 1 libro (in cartone)



+2
ANNI

10
PEZZI



Sporco-pulito, grande-piccolo, giorno-notte, pesante-leggero: ecco i concetti che si apprenderanno giocando con il puzzle dei grandi animali.



Giochi educativi

BJ698

gioco degli animali (in legno)
si gioca in due giocatori



Sfida l'avversario a trovare ciascuno degli animali dalla tua parte e fai lo stesso, a turno, facendo ruotare la lancetta degli animali. Il primo che riesce a capovolgere tutti gli animali dell'avversario sarà incoronato vincitore.

cm.27x28



Pescapesci magnetici

Servendosi delle apposite canne da pesca magnetiche, il bambino deve pescare i pesciolini (che resteranno attaccati alla canna da pesca!) e riposizionarli. Indicati per lo sviluppo della coordinazione occhio-mano e per l'affinamento dei movimenti.



06933

puzzle pescapesci con magneti +
2 canne da pesca magnetiche (in legno)



06809

set pescapesci magnetico (in legno)



Pizza delle frazioni

Sei fette di pizza in legno con una grande varietà di condimenti tra cui scegliere. Il bambino seleziona i condimenti e prepara la pizza, poi la taglia a fette con la rotella, e serve sul tagliere. Sul tagliere sono stampate le frazioni, per aiutare a sviluppare le abilità matematiche in modo originale e molto divertente per il bambino. Questo gioco inoltre incoraggia sessioni di gioco di ruolo interattive.



NOVITA'

BJ457

Il set include: tagliere, rotella, 6 fette di pizza, condimenti (18 pezzi)
Dimensioni: cm. 24x17x3h



Libro magnetico "gli alimenti"

Questo libro educativo include diversi giochi di smistamento, preziose informazioni sui vari gruppi di alimenti e tantissimi magneti colorati che aiutano il processo di apprendimento anche da parte dei più piccoli. Quali sono i gruppi alimentari? Cosa sono i nutrienti? Come si abbinano i cibi tra loro? Il gioco consente di insegnare ai bambini concetti importantissimi e molto attuali sulla corretta alimentazione, favorendo anche lo sviluppo del linguaggio e la conoscenza dei termini.

+3
ANNI



NOVITA'

12948

libro magnetico gli alimenti
Dimensioni: cm. 54x17,5

Rane e grilli salterini

VK1101

barattolo rane colori assortiti
(in plastica)



+3
ANNI

16
PEZZI



09375

barattolo grilli colori assortiti
(in plastica)



+3
ANNI

16
PEZZI



09376

valigetta grilli colori assortiti
+ 4 vaschette (in plastica)



+3
ANNI

36
PEZZI



10334

set 10 rane + 10 grilli + 2 bacinelle
colori assortiti (in plastica)



+3
ANNI

1
SET



10 RANE
10 GRILLI
2 BACINELLE





09356
gioco di società "Gioco dell'oca"

ASSORTITI +7 ANNI



09358
gioco di società "Lui chi è?"

ASSORTITI +7 ANNI

Indovina la figura misteriosa che si cela dietro la carta dell'avversario. Possono giocare due o più bambini, di tutte le età.



05916
gioco di società "Identiquiz"

ASSORTITI +7 ANNI

OLTRE
30.000
DIFFERENTI
COMBINAZIONI!

09354
gioco di società "Combina 4"

ASSORTITI +7 ANNI

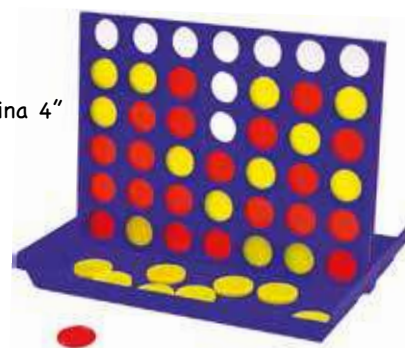

09357
gioco di società "Europoli"

ASSORTITI +7 ANNI

Gioco di strategia che aiuta il bambino a familiarizzare con il denaro e con i concetti ad esso correlati.



09359
gioco di società "Tombolina"

ASSORTITI +7 ANNI

Puzzle educativi



MAXI
cm.70x70

Componi il bellissimo puzzle rotondo e fai il giro della penisola!

11433

puzzle in cartone "L'Italia"
+ 1 libretto (in cartone)



Parti alla scoperta dell'Italia con questo fantastico puzzle rotondo e con un libro ricco di giochi, curiosità, quiz e tante informazioni! Ti divertirai a scoprire un bellissimo paese, a Venezia a bordo di una gondola, a Roma in compagnia dei centurioni, giungendo fino agli antichi templi di Agrigento.

**PUZZLE
ROTONDO
200 PEZZI**



MAXI
cm.96x68

11434

puzzle in cartone "la terra"
+ 1 libretto (in cartone)



Fai il giro del mondo e scopri le curiosità più affascinanti del nostro bellissimo Pianeta! Parti per un emozionante viaggio attraverso i due emisferi: guarda quanto sono profondi gli oceani, scopri gli animali più grandi e quelli più feroci, conosci le mega costruzioni più curiose e strabilianti! Leggi il libro, impara tante curiosità e metti alla prova la tua memoria componendo il puzzle da 205 pezzi!

**PUZZLE
OVALE
205 PEZZI**



BJ098

puzzle "Mondo" (in legno)
+ 1 libretto



Un gioco educativo che offre parecchi spunti di dialogo e apprendimento. Lasciate che i bambini esplorino paesi e i continenti del mondo e ne scoprano i monumenti più famosi, flora, fauna... Una volta completato il puzzle, i bambini possono parlare dei luoghi che hanno visitato o vorrebbero visitare, di come è il tempo nelle diverse parti del mondo, dei posti in cui vivono gli animali...

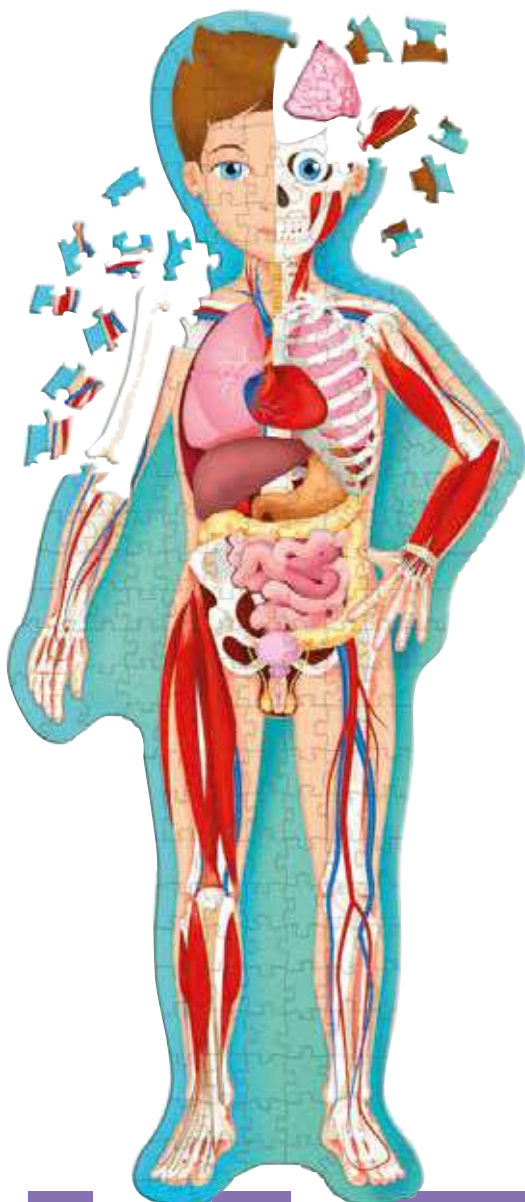

Il corpo umano

PUZZLE
200 PEZZI
+ 10 SPECIALI

MAXI
cm.135x60



11432

puzzle sagomato (in cartone)
(200 pezzi + 10 speciali) + 1 libretto



Esplora il corpo umano e scopri com'è fatto! Impara tante curiosità sullo scheletro, i muscoli, la circolazione sanguigna, la respirazione, la digestione e come funziona il cervello.

Schema corporeo

04688

set schema corporeo

Contiene:
 puzzle in legno schema corporeo
 (18 pezzi)
 + banda magnetica adesiva
 cm.50x5 h
 + lavagna magnetica cm.70x100



Lo schema corporeo puzzle è un grande e maneggevole puzzle di legno per bambini di 4 e 5 anni. Attraverso i tasselli, differenti per il volto e per i genitali, il bambino impara a comporre la figura di un maschio o di una femmina. Questo gioco aiuta i piccoli nel consolidare lo schema corporeo, cioè la rappresentazione mentale del corpo umano, della disposizione di arti e organi e del loro rapporto con lo spazio.



04689

banda magnetica adesiva
 (per magnetizzare lo schema corporeo)



18 PEZZI
 IN LEGNO



04687

puzzle schema corporeo (in legno)



Pregrafismi

Sviluppano la coordinazione occhio-mano e le direzioni visive. Ideale per i primi esercizi di scrittura.

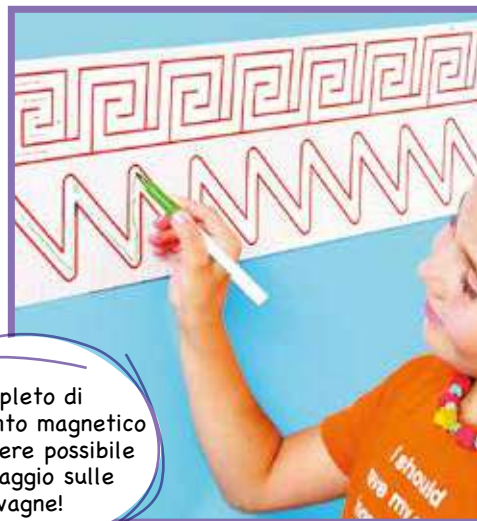
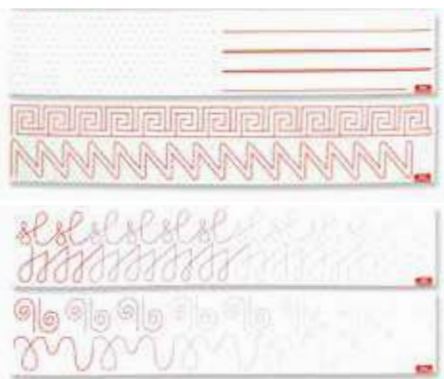

10398
set 4 bordi grafici

CM.98x17
CAD.

+3
ANNI

4
PEZZI

Completo di supplemento magnetico per rendere possibile l'ancoraggio sulle lavagne!

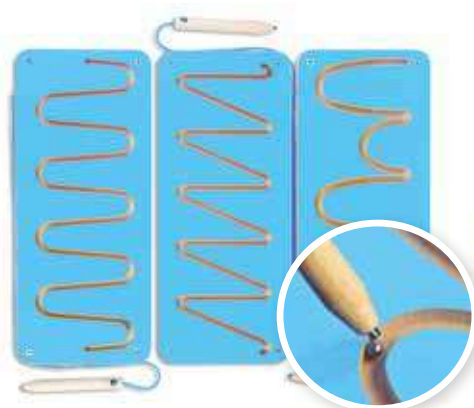

magnetica

10396
tavoletta magnetica (3 pezzi)
completa di penna e biglia

CM.35x15
CAD.

+3
ANNI

3
PEZZI



10397
tavola manipolativa con penna

CM.30x21

+3
ANNI

3
PEZZI



Banda dei numeri

10371
banda dei numeri (in plastica)

10372
banda dei numeri + 45 orsetti (in plastica)

CM.50x9
BNADA

+3
ANNI

46
PEZZI



POSIZIONAMENTO

NORMOGRAFO

PREGRAFISMO

ASSOCIAZIONE



Pregrafismi

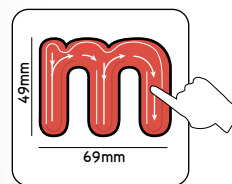

BJ508

tavola dei pregrafismi ALFABETO (in legno)



Le frecce stampate su ogni numero e lettera, indicanti il senso di scrittura, consentono al bambino di seguire con il dito per imparare a scrivere i caratteri alfanumerici.

Le 18 schede che proponiamo sono composte da esercizi-gioco suddivisi in 4 livelli progressivi di difficoltà, che consentono al bambino di familiarizzare con i movimenti grafici fino ad arrivare a una breve introduzione all'alfabeto, con schede-gioco per le varie lettere, sempre associate a una figura che richiama l'attenzione del bambino.



07543

set schede per pregrafismi
(in cartoncino)
contiene: 6 lavagne cancellabili,
6 pennarelli, 1 dorsino legafogli



BJ090

lettere minuscole (in legno)



BJ091

lettere maiuscole (in legno)



430 Prime esperienze di gioco

Tavole smerigliate

NOVITA'

12876

numeri smerigliati in scatola di legno da 1 a 10
Misura della scatola: cm.18x9,6x7



+3
ANNI

10
PEZZI



Gioco montessoriano di pregrafismi che favorisce l'apprendimento della scrittura, del linguaggio e della matematica, nonché lo sviluppo della motricità fine e della coordinazione occhio-mano. Superficie ruvida al tatto, "smerigliata".

Scopo di questo gioco è aiutare il bambino a imprimere la forma nella memoria muscolare: il bambino tocca la lettera o il numero seguendo il movimento della scrittura, imparando nome, suono, forma.

NOVITA'

12875

lettere smerigliate in scatola di legno
26 lettere maiuscole e 26 minuscole
Misura della scatola: cm.22x11,5x7,5



+3
ANNI

52
PEZZI



Pregrafismi

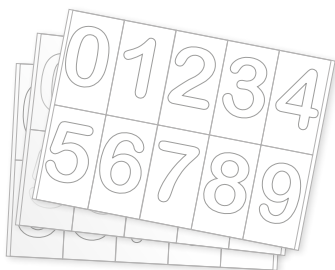

11582

numeri (in cartoncino)
80 positivi e 80 negativi



+3
ANNI

160
PEZZI

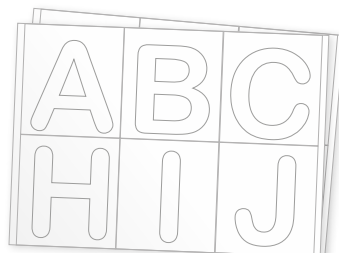

11599

lettere (in cartoncino)
84 positivi e 84 negativi



+3
ANNI

168
PEZZI



11600

numeri (in feltro adesivo)
10 positivi e 10 negativi



+3
ANNI

20
PEZZI



07168

numeri (in sughero)
20 positivi e 20 negativi



+3
ANNI

20
PEZZI



07166

lettere (in cartoncino ondulato)
28 positivi e 28 negativi



+3
ANNI

28
PEZZI



Tabellone/Lavagna abecedario



retro



11462

tabellone/lavagna abecedario per lo studente (in cartoncino)

CM.24x34

+3 ANNI

SCRIVIBILE
CON MARKER
CANCELLABILE



07387

set 2 tavole dei numeri da 0 a 9 (in plastica)

CM.13x34
CAD

+3 ANNI

2 PEZZI

Schede bianche

Schede bianche in cartoncino su cui colorare, disegnare vari soggetti, scrivere lettere o parole, applicare uno sticker.

SCHEDE BIANCHE GR.240

12093

60 schede cm.6x6

12094

30 schede cm.10x10

12095

30 schede cm.11x16

12096

30 schede cm.14x20

12097

30 schede cm.17x25



SCHEDE BIANCO-GRIGIO GR.500

08544

50 schede cm.11x17,5 + copertina

08545

50 schede cm.14x20 + copertina



12098

schedario + 50 schede bianche (in cartoncino)

CM.10x10
SCHEDA

+3 ANNI

51 PEZZI



432 Prime esperienze di gioco

Labirinti magici

I labirinti, assortiti in due differenti gradi di difficoltà, consentono al bambino di associare il movimento della propria mano a quello del percorso scelto, muovendo gli orsetti magnetici all'interno di esso.

IMPUGNATURA CON
ORSETTO MAGNETICO



8 DIFFERENTI MODELLI



07919

set 8 labirinti cm.32x23 assortiti in due gradi di difficoltà, 8 orsetti magnetici e 8 impugnature per muovere gli orsetti



07920

set "Labirinti Magici"
Contiene: 1 supporto in legno, 8 labirinti cm.32x23 assortiti in due gradi di difficoltà, 8 orsetti magnetici e 8 impugnature



Set Zanzibar

Un gioco divertente che consente al bambino di manipolare, giocare, scrivere usando la morbida e igienica sabbia. Ideale per esperimenti tattili e attività di pregrafismo.



06821

sacchetto da kg.2 cad.
sabbia bianca finissima "Zanzibar"

06820

Set "Zanzibar"
contiene:
1 vassoio cm.43,5x30
(manici compresi)
1 spatola cm.27x5
3 spatole pettine
1 spatola per scrivere
2 kg. sabbia bianca



12566x6

6 spatole in legno

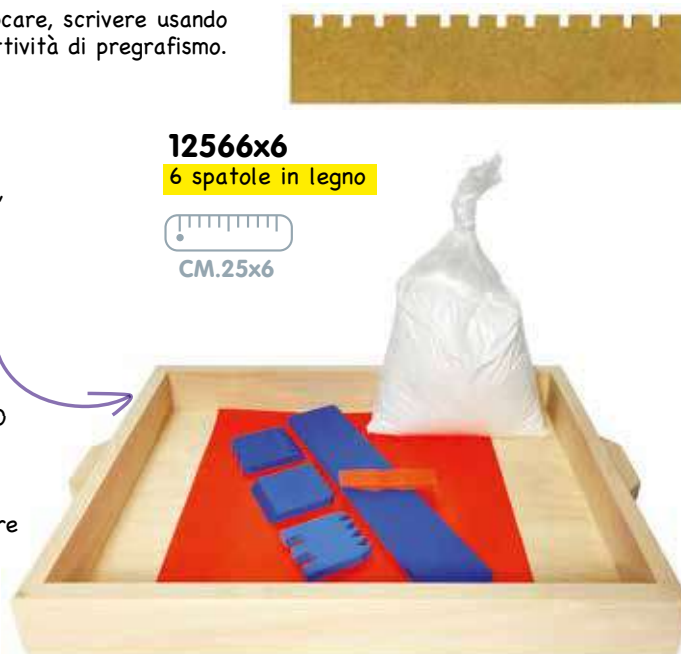

Circuiti Curve e Onde

Indicato per i più piccoli, favorisce lo sviluppo motorio e creativo dei bambini stimolando alcune fondamentali abilità di apprendimento: direzioni visive, coordinazione occhio-mano, riconoscimento e discriminazione di forme e colori.

MCW1002

circuito "Curve e Onde"
(in plastica/legno)



+18
MESI



Pathfinder

Questo gioco sviluppa le abilità di ragionamento logico, la coordinazione occhio-mano e le direzioni visive.

PF100

labirinto pathfinder + istruzioni
(in legno)



+18
MESI



Pannelli Manipolativi

Pannelli in multistrato di betulla, consentono a più bambini di giocare insieme, favorendo lo sviluppo delle capacità visive, della coordinazione occhio-mano e il riconoscimento di forme, colori, direzioni. I pannelli possono essere fissati a parete utilizzando la minuteria art. 10316 oppure posizionati a terra con l'utilizzo della minuteria art. 10318.

+3
ANNI



Esempio di posizionamento dei pannelli a terra



10310

pannello tattile
con materiali diversi
cm.50x50 (in legno)

10318

● kit 2 basi + minuteria per il
fissaggio dei pannelli a terra
(in legno)

● 10316

kit minuteria per il fissaggio
dei pannelli a muro

10317

kit 4 basi + minuteria
per il fissaggio superiore
dei pannelli nella
composizione a cubo

Teatrino



10304
pannello teatrino
cm.50x50 (in legno)



pag.636

tavolo basso

pag.517

burattini da dita



Pannelli Manipolativi

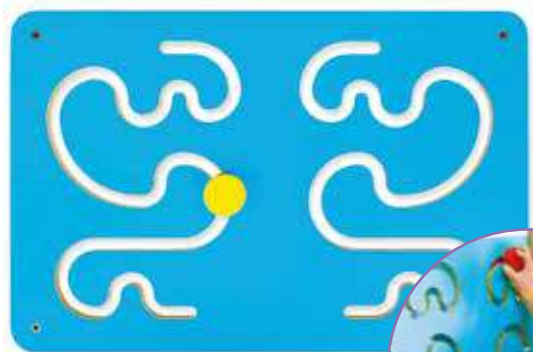

10395
pannello manipolativo (in legno)



+3
ANNI



10394
pannello manipolativo (in legno)
con impugnature con chiusura in velcro



+3
ANNI

Nuvola del tatto

10311
nuvola per pregrafismo e tatto
(in legno)



+3
ANNI



Infilature

pag.208

lacci in tessuto

Ideali per giochi matematici e sequenziali, allacciature, riconoscimento dei colori.



1117
busta 50 perle \varnothing cm.2,5 - gr.430
colori assortiti (in plastica)

Ø CM.2,5 PERLA

 +3 ANNI

 50 PEZZI

1117/V
valigetta 50 perle \varnothing cm.2,5
colori assortiti

Ø CM.2,5 PERLA

 +3 ANNI

 51 PEZZI



dimensioni reali



12339
140 perle da infilare **MEDIE** cm.2
forme e colori assortiti (in plastica)
cordoncini inclusi

CM.21x15,5x11,5 BAULETTO

 +3 ANNI

 140 PEZZI

12340
100 perle da infilare **GRANDI** cm.4
forme e colori assortiti (in plastica)
cordoncini inclusi

CM.26x18,5x13,5 BAULETTO

 +3 ANNI

 100 PEZZI



10142
vassoio (in plastica)

CM.28x36

 +3 ANNI

Forme e colori diversi consentono d'insegnare i concetti di sequenza, discriminazione, seriazione e di sviluppare la coordinazione motoria. Un consiglio per gli insegnanti: inventate delle sequenze (4 perle cubiche verdi, 1 cubo giallo, 3 cilindri blu...) e chiedete ai bambini di ricostruirne una uguale.

Infilature

Le grandi perle in legno sono facili da maneggiare anche dai bambini più piccoli. Un gioco di infilature atto a sviluppare capacità motorie, destrezza e coordinazione occhio-mano. Grazie alle maxi perle i bambini potranno apprendere giochi di smistamento, seriazione, divisione per colore e anche le prime basi del conteggio. Il pratico secchiello include anche il cordoncino per infilare le perle.



NOVITA'

12919

perle in legno \varnothing mm.10/25
con cordoncino
(secchiello 150 pezzi)



17200

secchiello 240 perle (in plastica)
+ 4,4 MT. filo (perla \varnothing mm.23)

 **+3** **241**
ANNI PEZZI
CM.26x19x13
BARATTOLO

BJ662

barattolo 90 perle (in legno)
+ 5 cordoncini
(cubo cm.2x2, cilindro cm.3,
tondo \varnothing cm.2)

 **+3** **95**
ANNI PEZZI
CM.12x12x16
BARATTOLO



58908

cubetti con lettere per infilature
(in legno)

 **+4** **325**
ANNI PEZZI
MM.7x7
CUBETTO

05538

rocchetti colori assortiti
(in plastica)
+ cordoncini

 **+4** **122**
ANNI PEZZI
 \varnothing CM.3x3
ROCCHETTO



Infilature numeriche

Per completare i disegni degli animali della giungla, il bambino deve infilare i lacci attraverso i fori rispettando l'ordine numerico lungo il percorso. Molto indicato per l'insegnamento dei numeri e per lo sviluppo delle capacità motorie fini, questo gioco consente di mettere alla prova la capacità del bambino di affrontare due compiti contemporaneamente: seguire i numeri e allacciare.

Il set include 3 tavole in legno e 6 lacci colorati

NOVITA'

34050

infilature numeriche set 3 pezzi
"animali della giungla"



Infilature

Il bambino deve completare gli animali infilando i lacci negli appositi fori e allacciando i vari pezzi alla tavola. Un modo unico per sviluppare abilità di destrezza e coordinazione occhio/mano, aumentando anche i livelli di concentrazione!

Pratica scatola in legno contenente 8 pezzi in legno + 7 lacci



NOVITA'

BJ505

infilature animali set 4 tavole
scatola: cm. 12x6x15h



10378

tavola soggetti assortiti
(in legno) + cordoncini



04738

pesce arcobaleno (in legno)
+ cordoncini



438 Prime esperienze di gioco

Infilature

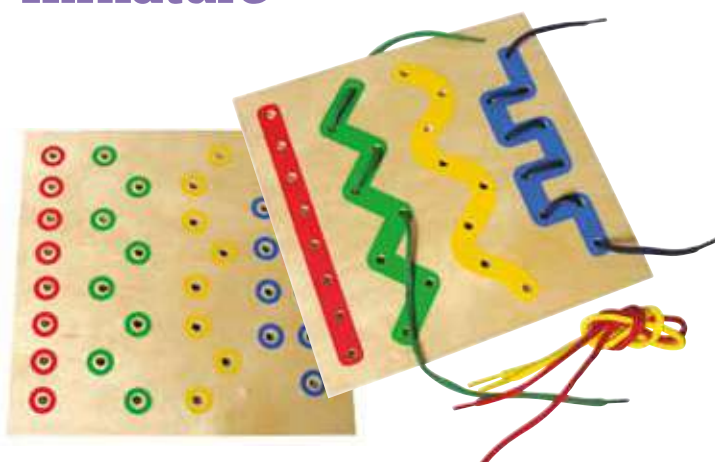

10380

tavola bifacciale "linee" (in legno) + cordoncini



CM.21x21



+4 ANNI



10379

tavola bifacciale "forme geometriche" (in legno) + cordoncini



CM.21x21



+4 ANNI

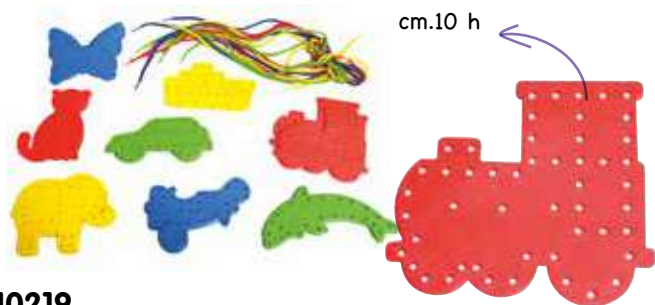

10219

MAXI infilature con cordoncini (in plastica) animali e mezzi di trasporto colori assortiti



CM.10 H



+4 ANNI



24 PEZZI

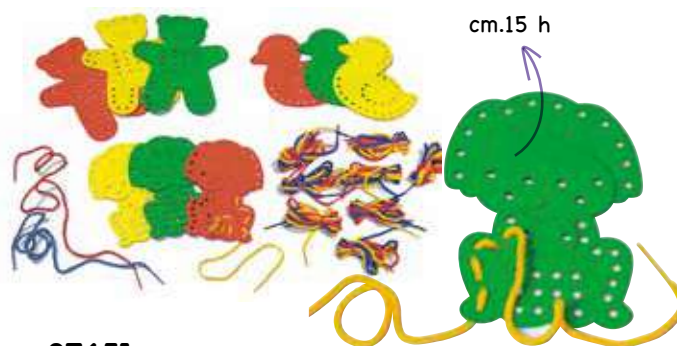

07651

MAXI infilature con cordoncini (in plastica) animali e colori assortiti



CM.15 H



+4 ANNI



9 PEZZI

04783

scatoletta bottoni + corda (in plastica)



Ø CM.2 BOTTONE



+4 ANNI



50 PEZZI



1712/20

cordoncino 20 MT



MT.20 CORDA



+4 ANNI



05816

busta 72 manine colorate (in plastica) + 6 corde cm.70



CM.3,5x5 MANINA



+4 ANNI



78 PEZZI

Bottoni manipolativi

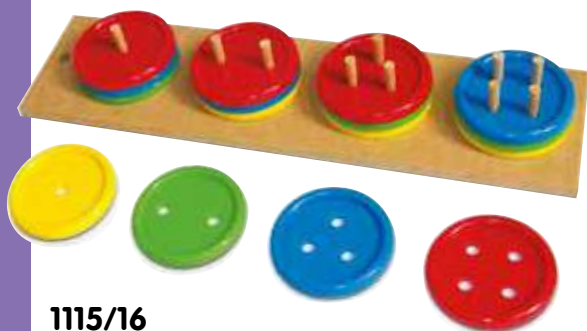

1115/16

gioco dei bottoni
base in legno + 16 bottoni (in plastica)



+4
ANNI

16
PEZZI

1115/96

busta con bottoni (in plastica)
colori assortiti



+4
ANNI

96
PEZZI



DecoPearl



12257

100 perle + vaschetta cm.21x23
(in plastica)



+3
ANNI

101
PEZZI



Ø mm.16

1115/V
valigetta dei bottoni (in plastica)
+ 6 MT. di cordoncino



+4
ANNI

48
PEZZI



Pomelli manipolativi

09914

base in legno con pomelloni
(in plastica)



+1
ANNI

25
PEZZI

09957

busta con pomelloni (in plastica)



+1
ANNI

50
PEZZI

Lavagna mosaico



08939

set 6 schede bifacciali per lavagna mosaico
soggetti assortiti



+5
ANNI

6
PEZZI



08940

carrello per lavagna mosaico



+5
ANNI



08938

scatola chiodini (in plastica)
assortiti in forme e colori



+5
ANNI

224
PEZZI



08937

base per lavagna mosaico
(in plastica)



+5
ANNI

Funghetti manipolativi



09889

70 funghetti colorati (in plastica)



09888

mosaico dei funghetti
base in legno + 70 funghetti



+5
ANNI

70
PEZZI

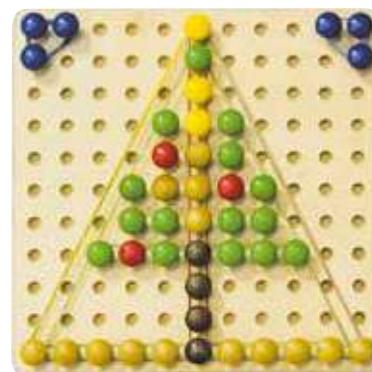

09887

mosaico dei funghetti
base in legno + 70 funghetti



+5
ANNI

70
PEZZI

Chiodini

Sulla base bianca forata è possibile realizzare i disegni, utilizzando chiodini in plastica a base quadrata, triangolare o tonda.

12348/1

chiodini PICCOLI busta gr.500



+3
ANNI

1200
PEZZI



12348/2

chiodini MEDI busta gr.500



+3
ANNI

800
PEZZI



12348/3

chiodini GRANDI busta gr.500



+3
ANNI

400
PEZZI



12348/4

chiodini ASSORTITI busta gr.500



+3
ANNI



06930x5

set 5 tavole forate per chiodini



+3
ANNI



Chiodini e infilature

12352

set chiodini e infilature completo di tavola, chiodini tondi assortiti in colori e misure, infilature con cordoncini



+3
ANNI





Logica, matematica sperimentazione

I bambini mostrano un'impressionante capacità di pensare in modo creativo. Incoraggiarli a utilizzare la logica e a pensare matematicamente è un ottimo modo per soddisfare il loro bisogno di attività intellettuali creative! Se poniamo problemi pratici e incoraggiamo i bambini a risolverli a modo loro, sperimentando concretamente, li aiuteremo a connettere le loro conoscenze informali con la matematica scolastica più formale, e soprattutto daremo loro modo di comprendere quanto teoria e pratica siano correlate.

454 Insiemistica

455 Abaci

458 Matematica

473 Sperimentazione

Domino

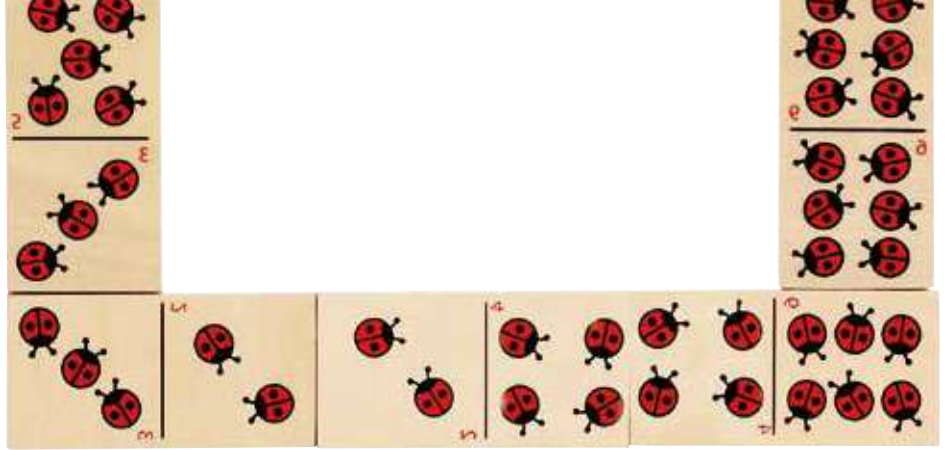

56716

domino coccinella (in legno)



+3
ANNI

28
PEZZI



cm.6x3

04731

domino degli animali (in legno)



+3
ANNI

20
PEZZI



La scatola in legno contiene 20 tessere che raffigurano degli animali. Il bambino dovrà abbinare le tessere sulle quali appare la stessa immagine.



cm.12x6

04747

domino dei sensi (in legno)



+3
ANNI

20
PEZZI



Un divertente gioco per aiutare i bambini a scoprire i cinque sensi. Il domino è composto da 20 maxi tessere sulle quali sono raffigurati uno dei sensi e un'immagine relativa a un altro senso (es. udito/torta). Il bambino dovrà abbinare le tessere in modo tale da associare ad ogni immagine il corrispettivo senso.



cm.15,5x7,5

● 04732

domino delle ombre (in legno)

 CM.12x6
TESSERA
+3
ANNI20
PEZZI

Ai vari soggetti, il bambino deve abbinare la loro ombra.

Una ricerca ottica non sempre facile, ma molto divertente. Il gioco è composto da 20 tessere, su ognuna delle quali sono raffigurate due immagini.



● 04733

domino delle relazioni (in legno)

 CM.12x6
TESSERA
+3
ANNI20
PEZZI

Un divertente gioco di relazione fra i vari soggetti, che affina le capacità logico/associative del bambino. Il gioco è composto da 20 tessere, su ognuna delle quali sono raffigurate due immagini.



● 10376

domino dei contrari (in legno)

 CM.15,5x7,5
TESSERA
+3
ANNI20
PEZZI

Ai vari soggetti si deve abbinare il suo contrario. Il gioco è composto da 20 tessere, su ognuna delle quali sono raffigurate due immagini.



Domino



10373

domino del colore (in legno)



+3 ANNI



● **10374**

domino "Davanti, dietro, sopra, sotto" (in legno)



+3 ANNI



10375

domino "Su, giù, destra, sinistra" (in legno)



+3 ANNI



Puzzle



10377

puzzle dei numeri (in legno)



+3 ANNI

16 PEZZI



Il gioco è composto da 16 tessere in legno. Su ogni tessera è raffigurato un numero, o il l'immagine ad esso corrispondente.



● **06377**

puzzle del colore (in legno)



+3 ANNI

24 PEZZI



cm.5x5

Il puzzle dei colori è composto da una tavola in legno e da 24 maxi tessere, su ognuna delle quali è illustrata una macchia di colore. Il bambino deve posizionare tutte le 24 tessere sulla tavola incastrandole tra loro nel modo corretto.

● 04699

puzzle "Prima e dopo" (in legno)





CM.24,5x9,5
CARTELLE

Gioco autocorrettivo composto da 30 pezzi che, abbinati tre a tre, formano 10 cartelle di cm.24,5 x 9,5. In ogni cartella è rappresentata una situazione che si modifica nel tempo in seguito a un'azione (prima-durante-dopo).



● 04698

puzzle: "Luci e ombre" (in legno)





CM.24,5x9,5
CARTELLE

A ogni soggetto colorato corrisponde la stessa immagine sia in negativo che in positivo. Il bambino deve trovare le tre tessere e incastrarle, così da formare una cartella con le tre versioni dello stesso disegno. Composto da 30 tessere che, abbinata tre a tre, formano 10 cartelle di cm.24,5 x 9,5.



04697

puzzle: "Il tempo" (in legno)





CM.17x12
CARTELLE

Questo gioco a incastro aiuta gli educatori ad insegnare il concetto dello scorrere del tempo. Composto da 24 pezzi che, abbinati 3 a 3, formano 8 cartelle di cm.17 x 12. Ogni cartella rappresenta 3 cambiamenti che avvengono nel tempo.



Lotto



cm.17,5

Metti alla prova la tua memoria!

BJ791

set 4 tavole Lotto degli animali (in legno)

CM.17,5x17,5
TAVOLA

+3
ANNI

1
SET



tessera
cm.5,5x6

cartella
cm.11,5x12,5

04728

lotto: tombola dei vegetali (in legno)

CM.5,5x6
TESSERA

+3
ANNI

30
PEZZI

Gioco composto da 6 cartelle e da 24 tessere stampate a colori, su ognuna delle quali è raffigurato in modo semplice e chiaro un vegetale. Il bambino deve associare le varie tessere alle corrispondenti immagini sulle cartelle.



tessera
cm.5,5x6

04729

lotto: tombola delle quantità (in legno)

CM.5,5x6
TESSERA

+3
ANNI

28
PEZZI

Lotto delle quantità. Indispensabile per insegnare al bambino le prime nozioni di matematica e insiemistica. È composta da 4 tavole, su ognuna delle quali sono raffigurate 6 diverse immagini colorate, e da 24 tessere. Il bambino deve abbinare a ogni immagine della tavola la corrispettiva tessera.

Memory del colore

08428

valigetta "Memory del Colore"



+3
ANNI

20
PEZZI



Ø cm.6

Contiene: 20 grandi bottoni in 10 differenti colori.
A seconda delle abilità degli allievi, l'insegnante mostrerà tre o più bottoni, poi li capovolgerà e, magari dopo averli mescolati lentamente, chiederà ai bambini di individuare il bottone di uno specifico colore, oppure di trovare due bottoni uguali...

Tombola dei colori

56705

tombola dei colori (in legno)



+3
ANNI

95
PEZZI



cm.21x14,5

Chi sarà il primo a completare la sua tavola?

Questo gioco di dadi (per 2/4 giocatori) insegna la giusta corrispondenza dei colori.
Contenuto:
- 4 tavole (casa, fattoria, acquario, mare)
- 15 pedine per ciascun colore (giallo, rosso, violetto, blu, verde, arancione)
- 1 dado colorato

Tavolette dei colori

Gioco montessoriano per imparare i colori e sviluppare la capacità del bambino di distinguere tra le diverse tonalità, nonché sviluppare un vocabolario specifico relativo al mondo dei colori ed accrescere le capacità mnemoniche. Il gioco è composto da 3 scatole in legno, ognuna contenente un numero crescente di tavolette colorate.

Si comincia dalla scatola più piccola, contenente 6 tavolette assortite nei 3 colori primari. Ai bambini verrà chiesto di abbinare le tavolette di uguale colore, poi di cercare nella classe un colore uguale a quello di una tavoletta ecc. In questo modo i bambini potranno familiarizzare con i colori primari, imparare i nomi dei colori e a distinguere un colore dall'altro.

Si procede poi con la seconda scatola, contenente 22 tavolette (2x11 colori), per poi passare alla terza scatola, contenente 63 tavolette (7 tavolette per 9 tonalità di colore).

Misura scatole:

cm.26x26x5 cm.25,4x9,6x5 cm.9,5x9,5x5



NOVITA'

12878

tavolette dei colori



+3
ANNI

91
PEZZI

Orologi

Un ottimo modo per insegnare ai bambini i vari concetti relativi al tempo: orario, diverse stagioni, giorni/date, mesi/anni

La lavagna dispone di un quadrante colorato con lancette mobili, orologi a 12 e 24 ore e magneti che indicano stagioni, giorni ecc. (in lingua inglese). Composto da 73 elementi gioco.



BJ592

tavola magnetica del tempo (in legno)



Sulla stessa tavola i bambini possono imparare i giorni in numeri e i giorni della settimana, i mesi, le condizioni meteo e le stagioni.

BJ526

calendario e orologio "Impara l'inglese" (in legno)

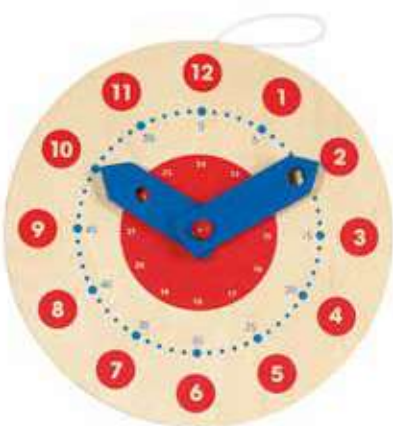

58980

orologio "Impariamo le ore" (in legno)



05537

orologio (in materiale acrilico)



I numeri sono estraibili e riposizionabili!

Clessidre

Per l'insegnante



BJE0002

clessidra GIGANTE 1 minuto per l'insegnante
cm.7,2x7,2x16,5



Per gli alunni



BJE0026

PACK SCUOLA (5 pezzi)
clessidra 1 minuto
per la classe - cm.1,8x1,8x9



Per l'insegnante



BJE0004

clessidra GIGANTE 3 minuti per l'insegnante
cm.7,2x7,2x16,5



Per gli alunni



BJE0016

PACK SCUOLA (5 pezzi)
clessidra 3 minuti
per la classe - cm.1,8x1,8x9



450 Logica, matematica e sperimentazione

Giochi d'equilibrio



HS530

torre in legno



+4
ANNI

51
PEZZI



HS973

torre in legno colorato



+4
ANNI

45
PEZZI

Un gioco di pazienza in 8 pezzi per stimolare la motricità.

Il dado colorato indica qual è il prossimo mattoncino da posizionare sulla mezza sfera.



HS129

torre in legno base \varnothing cm.6
(forme assortite + dado
+ sacchetto in cotone)



+3
ANNI

8
PEZZI

Tangram



Il gioco consiste nel disporre in piano tutti i pezzi in modo da formare figure riconoscibili.

07216x4

4 set GRANDE TANGRAM SCUOLA
(7 pezzi per ogni set) in EVA



+3
ANNI

4
SET

1144

4 set tangram
(7 pezzi per ogni set) in materiale acrilico



+3
ANNI

4
SET

07243x4

4 set GRANDE TANGRAM SOFT
(7 pezzi per ogni set) in EVA



+3
ANNI

4
SET



ESEMPI

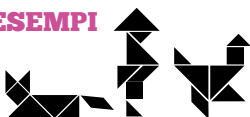

Orsetti didattici

La ricercata modularità di peso e le differenti dimensioni degli orsi consentono di insegnare ai bambini in modo facile e divertente le nozioni fondamentali di numerazione, seriazione, insiemistica, discriminazione di forme, colori e pesi. Nella confezione è incluso un pratico libretto che illustra alcuni degli innumerevoli giochi didattici realizzabili con la famiglia degli Orsi.

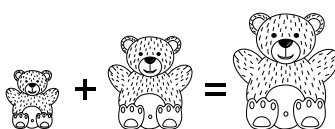

La famiglia degli orsi è composta da:

- 1 papà orso (gr.12)
- 1 mamma orso (gr.8)
- 4 orsetti (gr.4)



2 orsetti (gr.4) = 1 mamma orso (gr.8)

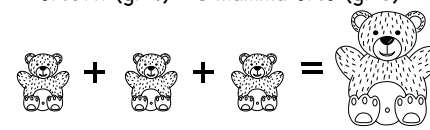

3 orsetti (gr.4) = 1 papà orso (gr.12)



1145/96
 valigetta orsetti (in plastica)
 contiene: 16 papà, 16 mamme, 64 orsetti
 + istruzioni

+3 ANNI **96 PEZZI**

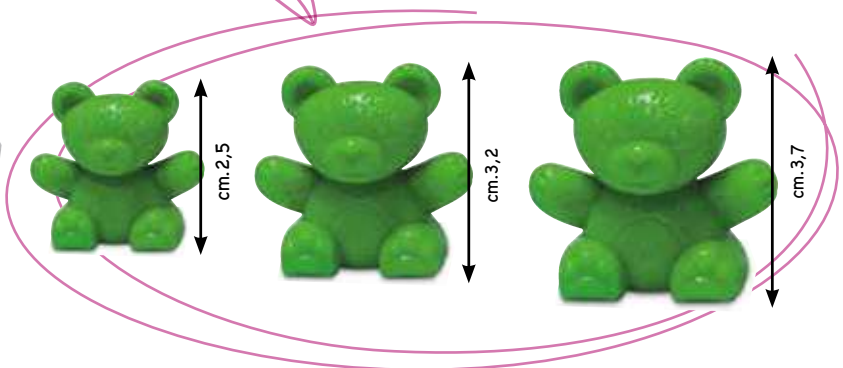

09371
 barattolo orsetti (in plastica)
 contiene: 7 papà, 7 mamme, 28 orsetti

+3 ANNI **42 PEZZI**

09572
 valigetta "Famiglie di orsetti" (in plastica)
 contiene: 120 orsetti, 6 vaschette,
 + istruzioni

+3 ANNI **126 PEZZI**



6 vaschette per esercizi di seriazione e insiemistica!

pag.474
 bilance

Piatti, ciotole e vaschette contenitori

Ideali per giochi di insiemistica e logica o perfette per riporre piccoli oggetti, come perline, tempere, pastelli a cera, ecc...

08101

ciotole in plastica
colori assortiti



12
PEZZI



09370

vaschette in plastica
colori assortiti



6
PEZZI



11812

vaschette in plastica



4
PEZZI



10333

ciotole ml.350 in plastica
colori assortiti



6
PEZZI



08102

piatti in plastica
colori assortiti



4
PEZZI



11519

ciotole in plastica
colori assortiti



10
PEZZI



04802

vaschette in plastica
con coperchio



6
PEZZI



09147

box in cartone con vaschette
(in plastica) con coperchio



6
PEZZI



Cerchi didattici

pag.468
blocchi logici

I cerchi sono snodabili e consentono di realizzare in modo pratico insiemi, intersezioni ecc... Consigliamo di utilizzare i cerchi con il supporto dei blocchi logici.

06467

cerchi per insiemistica pieghevoli e flessibili (2 per ogni colore)



+6
ANNI

6
PEZZI

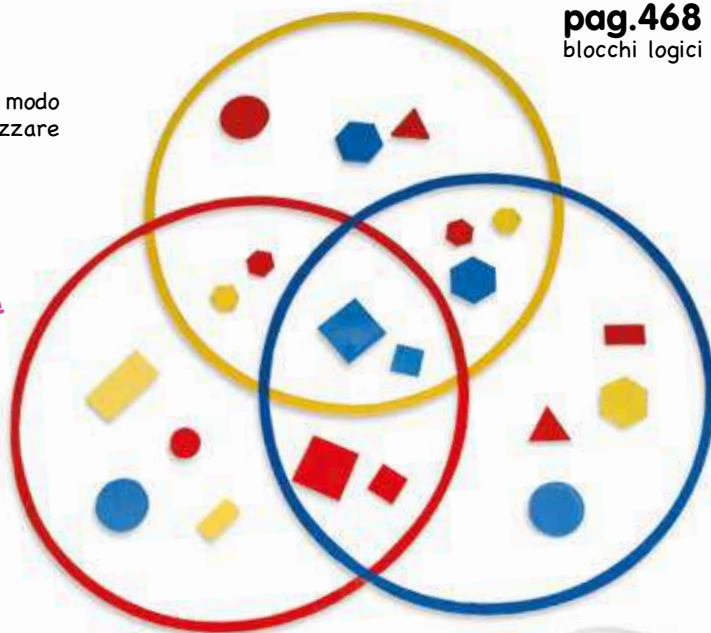

Tavolozza per operazioni aritmetiche

Set composto da una tavolozza e 60 perle colorate utili per insegnare il valore e i concetti basilari di numerazione, favorendo l'apprendimento in maniera efficace e divertente.

11849

tavolozza con 60 perle Ø 12 mm



+6
ANNI

61
PEZZI

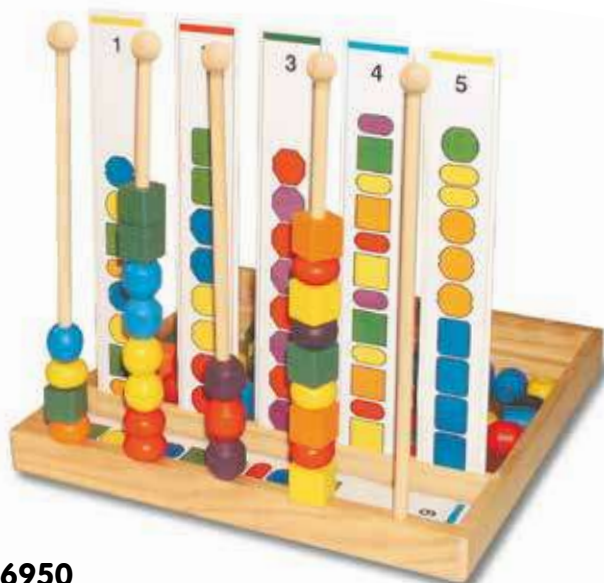

06950

abaco sequenziale (in legno)



+3
ANNI

55
PEZZI

Composto da 5 colonne verticali su cui andranno posizionate le perle in legno rispettando le sequenze suggerite dalle tessere-guida.



BJ531

set per imparare a contare (in legno)



+3
ANNI

55
PEZZI

Un modo originale per introdurre i bambini alla matematica e al conteggio. Sulla base in legno sono raffigurati dei puntini che rappresentano un numero da 0 a 9. I bambini devono abbinare il giusto numero ai puntini, e contare lo stesso numero di anelli da infilare sul piolo corrispondente.

Abaci

I concetti fondamentali che l'abaco consente di sviluppare sono:

- 1) i numeri: imparare i numeri da uno a dieci
- 2) i colori: associare ogni colore a un valore numerico
- 3) i calcoli: eseguire le prime operazioni aritmetiche con i cilindretti



1121

abaco scalare
contenuto: 2 basi con 5 fori, 10 aste a scalare, 60 cilindretti colorati



CM.15x38x18

+6 ANNI



1119

abaco multibase
contenuto: 5 asticcioline "base 4", 5 asticcioline "base 6", 5 asticcioline "base 10", 1 base con fori, 45 cilindretti colorati



CM.15x19x18

+6 ANNI

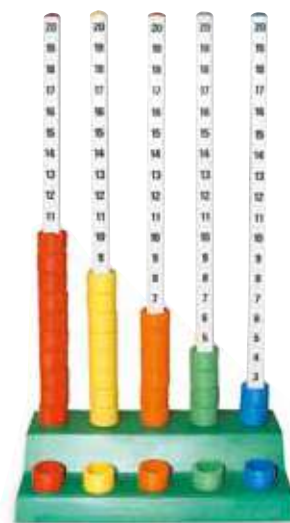

1118

numeratore a colonne
contenuto: 1 base con 5 fori, 5 aste numerate, 100 cilindretti



CM.15x19x35

+6 ANNI



07737

valigetta abaco base 1-4-6-10
contiene: 5 asticcioline "base 1", 5 asticcioline "base 4", 5 asticcioline "base 6", 5 asticcioline "base 10", 1 base con fori, 45 cilindretti



CM.19x6x15

+6 ANNI



07908

busta palline
(ricambio per abaco art. 07737)



Ø CM.2x1,5

+6 ANNI

45 PEZZI



1116

cilindretti colori assortiti
(per abaci art.1118, 1119, 1121, 1122)



Ø CM.2x1,5

+6 ANNI

30 PEZZI



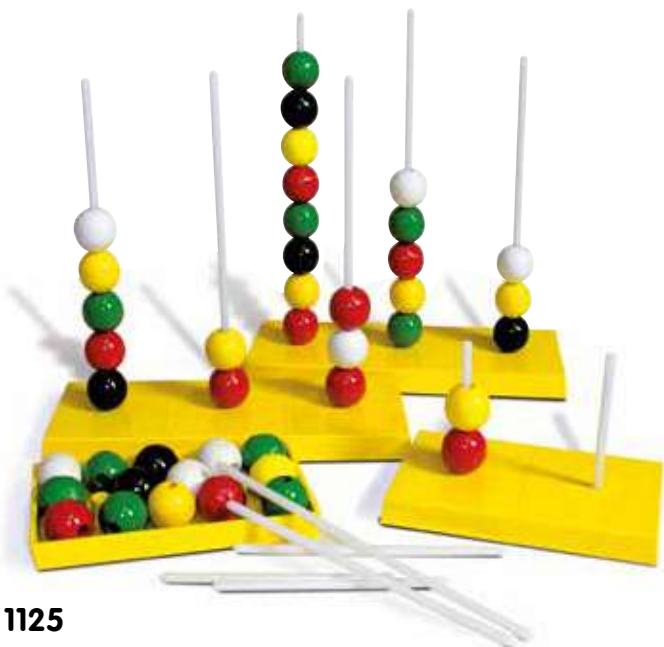

1125

abaco multibase
contenuto: 6 supporti da "base
3" a "base 10", 50 palline
forate colorate, asticcioline



+6
ANNI

120
PEZZI



11402

abaco sequenziale (in legno) numeri da 1 a 5



+6
ANNI

Strumenti utili per acquisire la consapevolezza della struttura polinomiale e le prime nozioni di aritmetica.



PALLINE BIG
25 MM



1117

busta palline forate
colori assortiti (per abaco art.1125)



+6
ANNI

50
PEZZI



11533

abaco sequenziale (in legno)



+6
ANNI

Abaco shape 'n color



SH7000

abaco "Shape'n color" (in plastica)



+6
ANNI

Il riconoscimento dei colori, delle forme e dei numeri, la capacità di contare e di raggruppare sono solo alcune possibilità d'insegnamento che questo gioco consente. La confezione contiene 50 pezzi in 5 forme e in 5 colori diversi e 18 schede/esempi che favoriscono un divertente gioco di memoria.

Abaco verticale

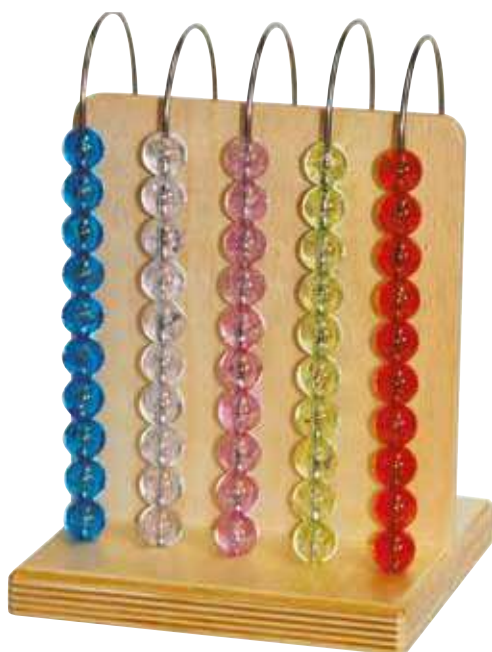

06939

abaco verticale (in legno)



+6
ANNI

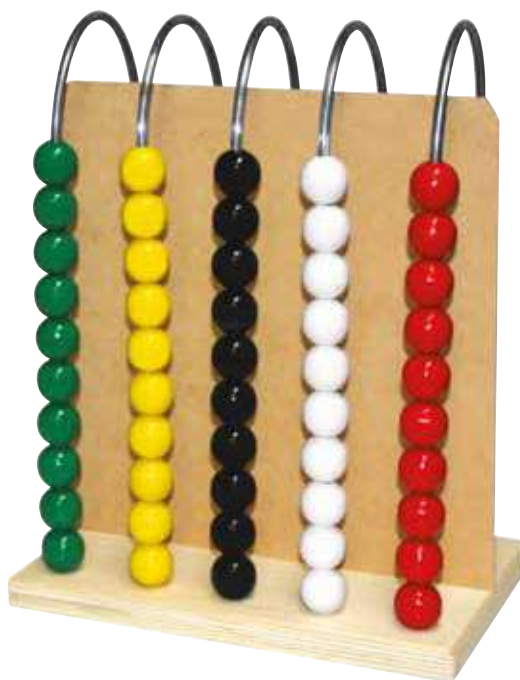

11666

abaco verticale "5 BIG" (in legno)



+6
ANNI

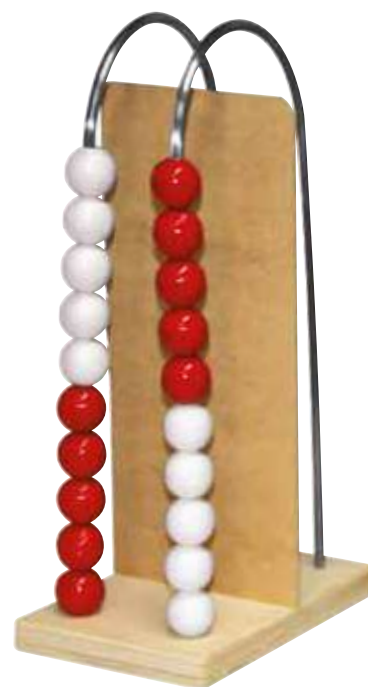

11665

abaco verticale "2 BIG" (in legno)



+6
ANNI

Abaco piano

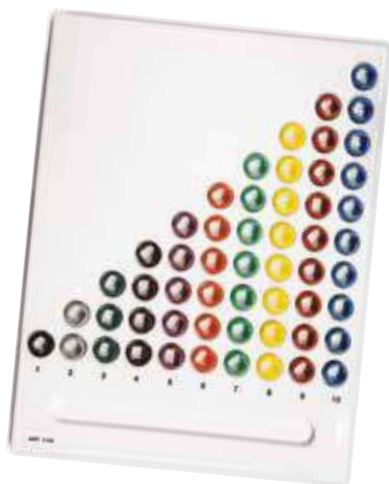

1122

abaco piano
contenuto: 1 piattaforma riportante
i numeri e 55 cilindretti colorati



+6
ANNI

Un'originale versione "orizzontale" dell'abaco che consentirà al bambino di esercitarsi e imparare i primi concetti aritmetici anche tenendo la tavola appoggiata sul banco.



Pallottolieri

Consentono di insegnare la numerazione e le operazioni matematiche basilari (addizione e sottrazione).

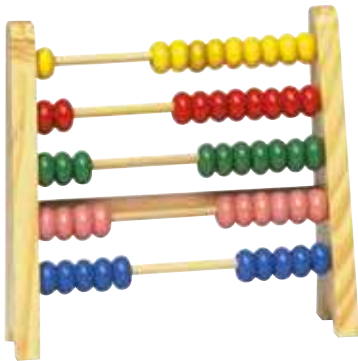

X066
pallottoliere (in legno)
 **+2 ANNI**
 CM.15x16



Pallottoliere GIGANTE
BB083
 pallottoliere gigante (da montare)
 **+2 ANNI**
 CM.70x91x30



06938
pallottoliere (in legno)
 **+2 ANNI**
 CM.22x7,5x29

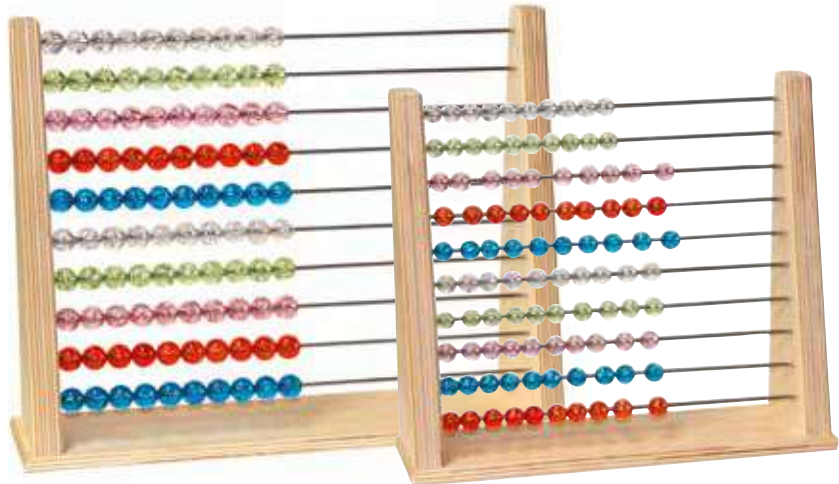

11774
pallottoliere (in legno)
 **+2 ANNI**
 CM.36x9x27

11750
pallottoliere (in legno)
 **+2 ANNI**
 CM.26x7,5x22

Numeri in colore

Numeri in colore/Regoli colorati

Questo gioco insegna al bambino importantissimi concetti matematici:

- 1) le equivalenze (un regolo arancione vale 10 regoli bianchi);
- 2) le associazioni valore numerico/colore;
- 3) i primi calcoli aritmetici (regolo rosso + regolo verde = regolo giallo)

10222

valigetta numeri in colore "START"



CM.20x23
VALIGETTA

+3
ANNI

200
PEZZI



1131

valigetta numeri in colore



CM.20x23
VALIGETTA

+3
ANNI

200
PEZZI



Grande gioco dei regoli

Per la maggior parte delle persone, entrare nel mondo delle addizioni e sottrazioni è tutt'altro che facile. All'inizio, il mondo astratto dei numeri sembra essere enigmatico e incomprensibile. Con questo grande gioco dei regoli (di 100 pezzi) i processi di calcolo possono essere colti nel vero senso della parola e, soprattutto, possono essere visti. Una comprensione di base del mondo dei numeri viene creata scherzosamente in un modo semplice e intuitivo. Tutti meritano di avere questo aiuto all'inizio!



58626

grande gioco dei regoli (in legno)



CM.27,5x27,5x11
BOX

+3
ANNI

100
PEZZI



$$6 + 3 + 1 = 10$$

Giochi educativi



BJ511

gioco delle sottrazioni e delle addizioni (in legno)



BJ538

scatola delle tabelline (in legno)

Flashcards

Le **FLASHCARD** sono uno degli strumenti più utilizzati per lo studio e la memorizzazione dei vocaboli.

Ispirate al metodo Montessori, permettono di svolgere diverse attività progressive per accrescere il riconoscimento di tantissime parole. Aiutano nella dizione e nella fonetica agevolando i bambini a pronunciare correttamente le parole e memorizzarle. E, per i più grandi, aiutano ad imparare i numeri, le operazioni matematiche e i giochi di carte. Resistenti, ideali per le classi.



CARTA:
CM. 5,8x8,8x2,8

+3 ANNI

52 PEZZI



33015

set flash cards "Addizioni 1-10"



33023

set flash cards "Sottrazioni 1-10"



33016

set flash cards "Moltiplicazioni 1-6"



33017

set flash cards "Moltiplicazioni 7-12"



33018

set flash cards "Divisioni 1-10"

Orologi dei numeri



11405

orologio dei numeri
12 cilindretti (base in legno)



CM.25x25x1,5
BASE

+6
ANNI

13
PEZZI

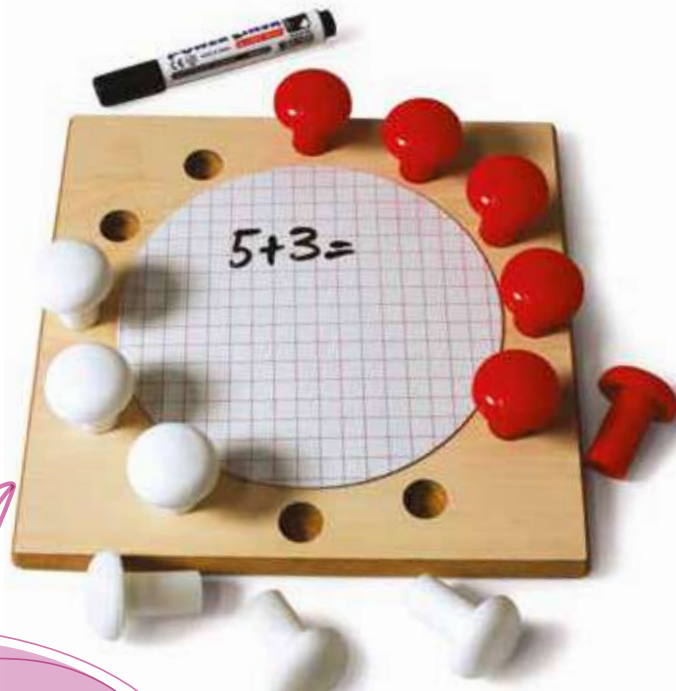

11406

orologio dei numeri
12 pomelloni manipolativi
(base in legno)



CM.25x25x1,5
BASE

+6
ANNI

13
PEZZI

Grazie a questi orologi è possibile insegnare ai bambini le prime nozioni di aritmetica in modo efficace e divertente, utilizzando i cilindretti colorati ed i pomelloni per eseguire i primi calcoli.

Tavole per numerazione

Perfette per insegnare a contare. I cilindretti di due colori diversi permettono di scomporre i numeri. Disponibili in base 10, 12 e 20.

11398

tavola numerazione
(base in legno) da 20 cilindri



CM.36x8x1,8
BASE

+6
ANNI

21
PEZZI

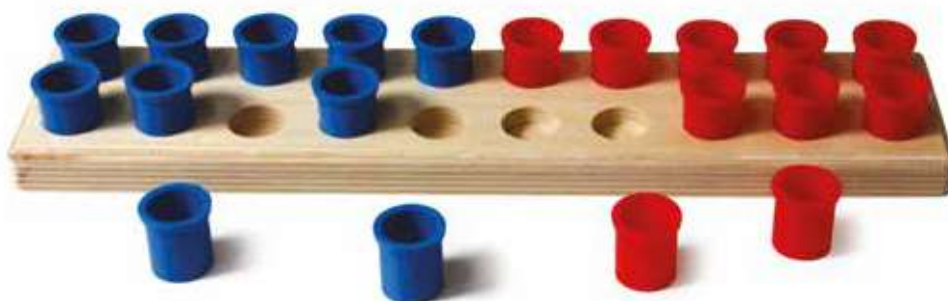

11399

tavola numerazione
(2 basi in legno) da 10 cilindri



CM.18x8x1,8
BASE

+6
ANNI

22
PEZZI



11400

tavola numerazione
(base in legno) da 12 cilindri



CM.22x8x1,8
BASE

+6
ANNI

13
PEZZI

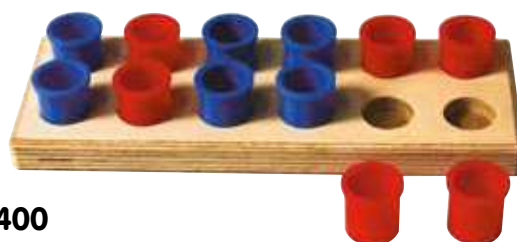

Insiemistica e matematica

11366

cilindretti colorati (in plastica)



+6
ANNI

32
PEZZI

Set composto da 32 elementi cilindrici colorati, utili per insegnare il valore e i concetti basilari di numerazione, favorendo l'apprendimento in maniera efficace e divertente.



ESEMPIO

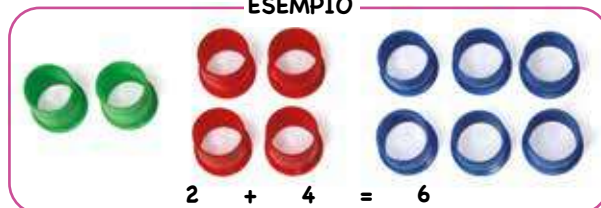

11410

busta cubi (in legno)



+6
ANNI

50
PEZZI



11411

barattolo cubi (in plastica)



+6
ANNI

350
PEZZI



BJ161

set dadi colorati (in legno)



+3
ANNI

12
PEZZI

Dadi da assemblare



07607

dadi forniti stesi (in cartone)



+3
ANNI

5
PEZZI

Dadi in cartone bianco da assemblare e personalizzare. Ideali per esercizi di calcolo, possono essere usati anche come dadi linguistici scrivendo sillabe, lettere o parole.



BJ162

set dadi (in legno naturale)



+3
ANNI

12
PEZZI



Collana dei numeri

pag.196-197

perle Kristall
e Tahiti

Uno strumento pratico ed efficace per insegnare le operazioni aritmetiche e i numeri fino a 20.

Aiuta i bambini a sviluppare strategie per eseguire addizioni e sottrazioni, come per esempio raddoppiare, compensare.

11404

collana dei numeri per BAMBINI
cordoncino + 20 perle (in plastica)



+3
ANNI

11878

collana dei numeri per BAMBINI
cordoncino + 20 perle (in plastica)



+3
ANNI

11403

collana dei numeri (in plastica)
per INSEGNANTI in valigetta
cordoncino + 20 perle Ø 25 mm
cordoncino + 20 perle Ø 12 mm

+3
ANNI



MATEMATICA

Set "Impariamo a contare"

07560 valigetta "Impariamo a contare"
contiene: bastoncini in legno da colorare,
1 scatola di acquerelli con pennello



+3
ANNI

Set composto da bastoncini in legno,
un pennello e degli acquerelli.

I bambini si divertiranno a dipingere i
bastoncini (seguendo possibilmente lo
schema cromatico dei numeri in colo-
re) per poi usarli come materiale di
esercizio aritmetico e di gioco libero.

CARTELLA COLORI:



1 2 3 4 5 6 7 8 9 10



Gioco delle operazioni matematiche

11401

gioco da parete o da tavolo in base 20 (10 palline rosse, 10 bianche) base in legno contiene una tavoletta scrivibile/cancellabile con marker (incluso)



CM.75x11x13
BASE

Elemento che permette agli insegnanti di dimostrare addizioni e sottrazioni fino a 20.

Esempio: scrivete un'addizione sulla tavoletta (5+2) e mostrate i due addendi con le palline rosse e quelle bianche.

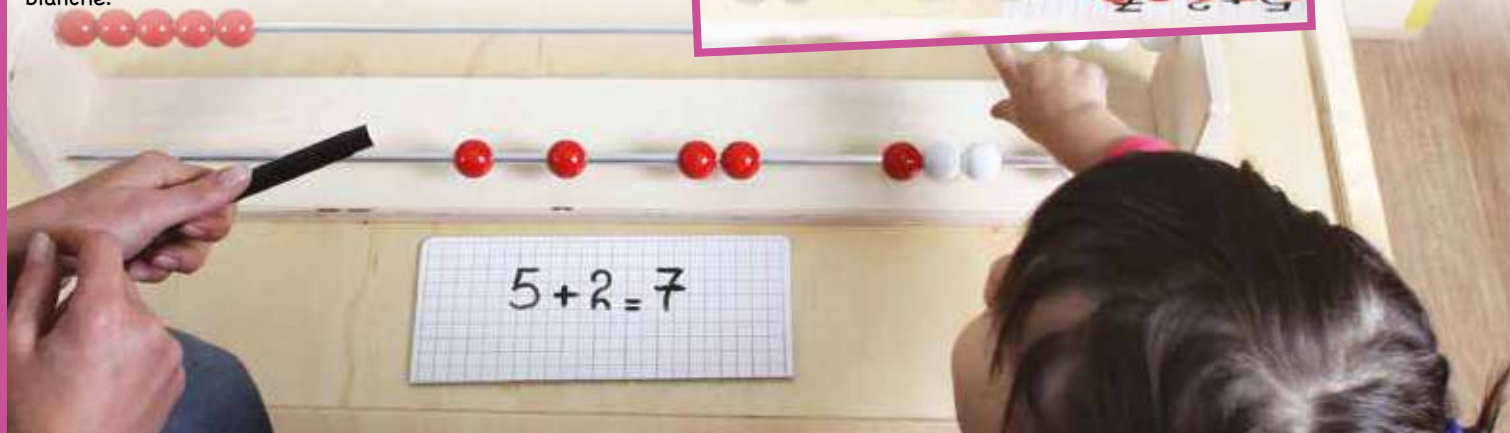

Calcolo multibase



05757

set gioco multibase (in legno)



ASSORTITI

+3 ANNI

594 PEZZI

I singoli elementi di questo gioco matematico sono evidenziati da un reticolato di cm.1. Gli elementi ed i supporti possono essere utilizzati in base 10.

Sistema di misurazione per l'apprendimento dei concetti basilari di volume.

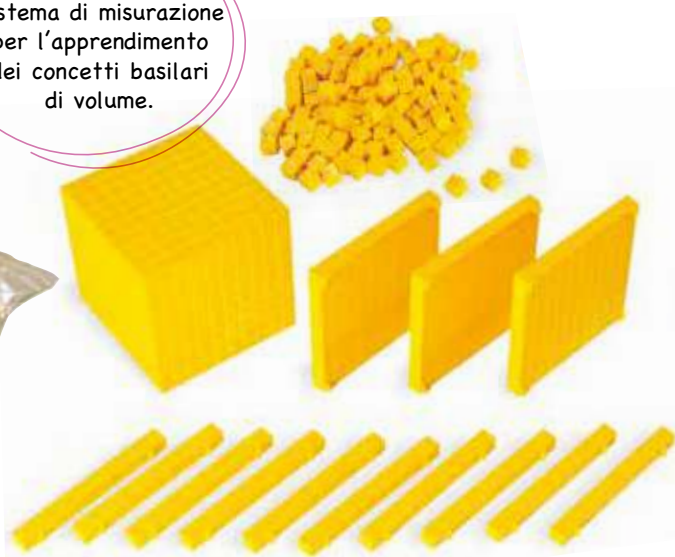

T1134

set gioco multibase (in plastica)
base 10: 1 cubo, 10 piatti, 10 lunghi, 100 unità



ASSORTITI

+3 ANNI

121 PEZZI

464 Logica, matematica e sperimentazione

Righelli aritmetici

Dotati di vano per posizionare i numeri in colore. Consigliati per scuole elementari e medie inferiori.

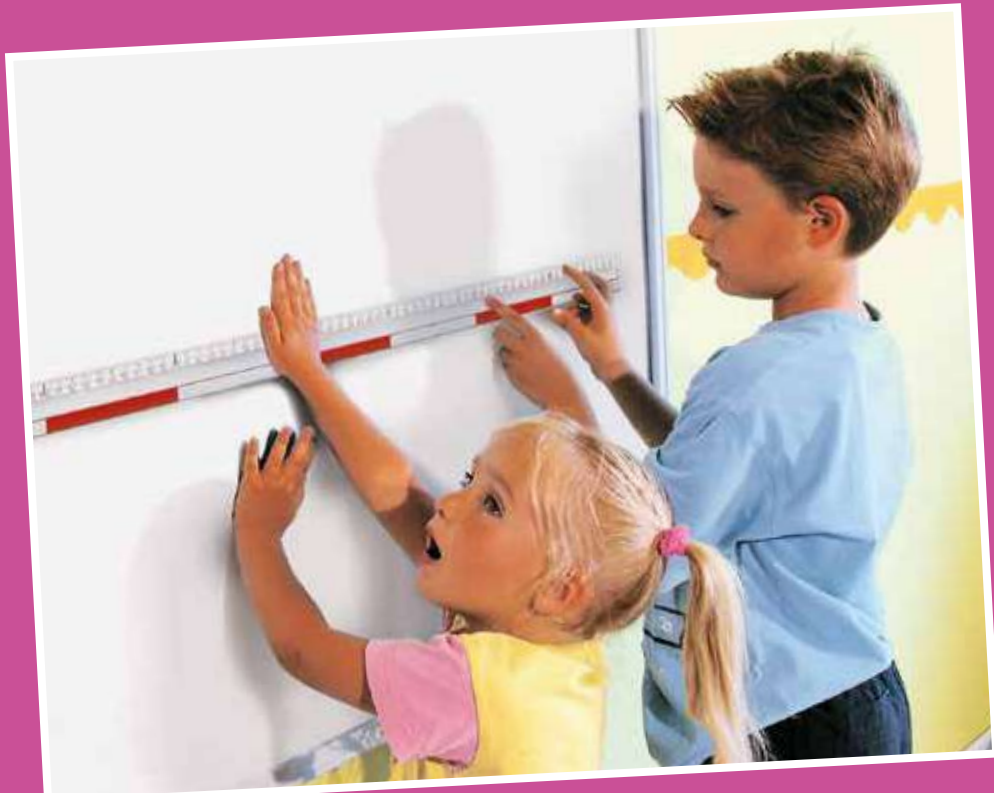

1136

metro lineare rigido cm.10 evidenziati



06966

righe per operazioni aritmetiche



06967

righe per operazioni aritmetiche "positivo-negativo"



Sistema metrico decimale

1137

Sistema metrico decimale

Tubo contenente: 10 stecche per ogni numero dall'1 al 10

+ 1 metro centimetrato dotato di vano per posizionare i numeri in colore per l'apprendimento delle 4 operazioni, dei decimali e delle lunghezze.



Giochi matematici

Questi giochi educativi aiutano i più piccoli a imparare le tabelline e i numeri con facilità, oltre a incoraggiare lo sviluppo motorio e le capacità di selezione.

I cubetti dai colori vivaci hanno le tabelline stampate su un lato e la risposta sull'altro!



BJ210

cubetti delle tabelline (in legno)



+3 ANNI

144 PEZZI

BJ144

cubetti dei numeri da 1 a 100 (in legno)



+3 ANNI

100 PEZZI



BJ210



BJ144

Pizza delle frazioni

Sei fette di pizza in legno con una grande varietà di condimenti tra cui scegliere. Il bambino seleziona i condimenti e prepara la pizza, poi la taglia a fette con la rotella, e serve sul tagliere. Sul tagliere sono stampate le frazioni, per aiutare a sviluppare le abilità matematiche in modo originale e molto divertente per il bambino. Questo gioco inoltre incoraggia sessioni di gioco di ruolo interattive.



NOVITA'

BJ457

Il set include: tagliere, rotella, 6 fette di pizza, condimenti



+3 ANNI

18 PEZZI



Puzzle delle frazioni

Questo puzzle introduce il conteggio e il concetto di frazioni utilizzando pezzi di puzzle in legno dai colori vivaci che includono numeri e forme. Abbinare le forme colorate ai numeri e ai colori sulla scheda di base e conta quanti pezzi fanno tutt'uno man mano che i pezzi si incastrano.



BJ459

puzzle "Le mie prime frazioni"
(in legno)

CM.38,5x22,5
TAVOLA

+3 ANNI

25 PEZZI

3 IN 1
MATEMATICA
GEOMETRIA
FRAZIONI



57737

puzzle del cerchio (in legno)
6 livelli

Ø CM.12

+3 ANNI

21 PEZZI



Il puzzle del cerchio insegna giocosamente le possibilità di divisione del cerchio.

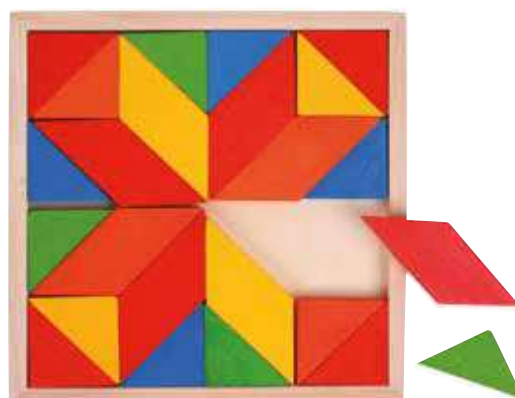

BJ246

puzzle mosaico (in legno)

CM.20x20

24 PEZZI

Puzzle mosaico composto da 24 pezzi di dimensioni e forme diverse. Il bambino può realizzare sempre nuove composizioni, oppure cercare di posizionare sulla base tutti i pezzi in modo corretto.

03634

gioco delle frazioni (in plastica)

CM.24x27x1
TAVOLA

+6 ANNI

51 PEZZI

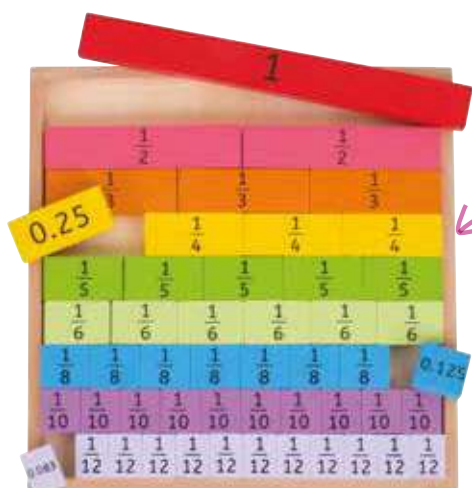

BJ229

gioco delle frazioni (in legno)

CM.30x30x1,8
TAVOLA

+6 ANNI

51 PEZZI

Blocchi logici

I blocchi logici sono stati adottati da noti pedagogisti allo scopo di aiutare i bambini ad apprendere in modo efficace e duraturo concetti molto importanti: discriminazione di forme, di colori, di spessori, insiemistica, geometria.



1105

scatola sagome logiche MINI
(5 forme geometriche in 2 dimensioni)

+3 ANNI 60 PEZZI

07734

valigetta sagome logiche:
(4 forme geometriche
in 2 diverse dimensioni)

+3 ANNI 48 PEZZI

1102

valigetta sagome logiche
(5 forme geometriche
in 2 diverse dimensioni)

+3 ANNI 60 PEZZI



1104

busta sagome logiche
(30 sagome piccole, 30 sagome medie)
assortite in 5 forme geometriche

+3 ANNI 60 PEZZI

Blocchi logici MAGNETICI

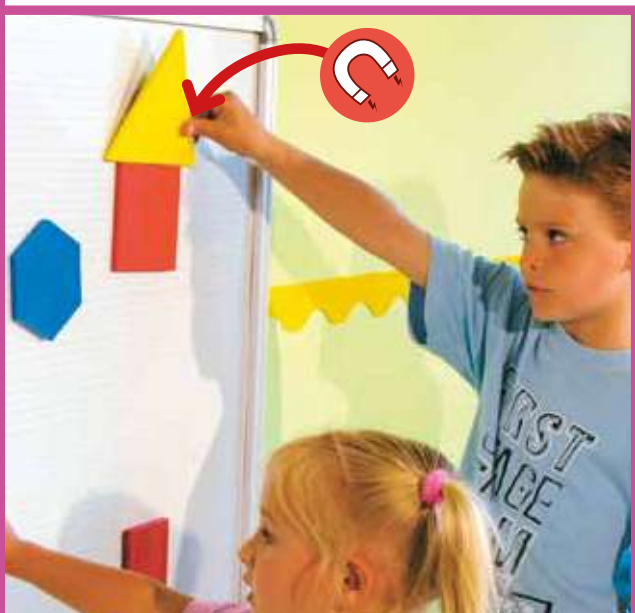

1108

busta sagome logiche magnetiche
(5 forme geometriche GRANDI in due spessori)
completa di banda per magnetizzarle

+3 ANNI 90 PEZZI 



1100

vassoio sagome logiche 5 forme
geometriche (30 sagome piccole,
30 sagome medie, 30 sagome grandi)

+3 ANNI 90 PEZZI

Solidi geometrici

1535

solidi geometrici (in cartone)
8 tavole



CM.25x35

+3 ANNI

Solidi geometrici da costruire. La confezione comprende 8 tavole. Su ogni tavola viene illustrato un solido geometrico già fustellato e cordonato (al fine di semplificarne la costruzione), correlato dalle corrispondenti forme geometriche.



GEOMETRIA

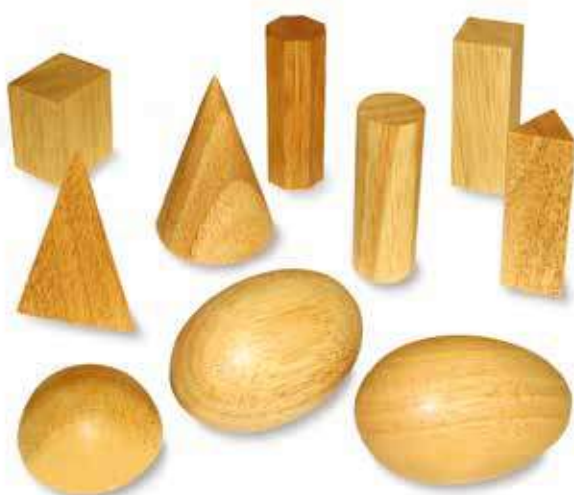

05759

set solidi geometrici
(in pregiato legno antisceggiato)
altezza max cm.8



ASSORTITI

+3 ANNI

10 PEZZI



06935

forme decrescenti (in legno)



CM.26x26x11

+3 ANNI

17 PEZZI

Ogni forma è assortita in 4 differenti misure (totale di 16 pezzi) posizionati su una tavola in legno.

Kubus

58649

gioco (in legno) KUBUS
include: 4 cubi + 26 tessere



CM.4x4x4 CUBO

+3 ANNI

30 PEZZI

Lo scopo del gioco è posizionare i 4 dadi secondo il modello indicato sulle tessere. Questo promuove la cognizione di forme e colori.



Quadrati matrioska

Le possibilità di gioco sono infinite con questo gioco impilabile. Senza linee guida o regole, i giovani creativi possono impilare i quadrati in qualsiasi modo decidano, scoprendo usi unici per ciascuno dei quadrati. Le piccole mani possono assemblare una varietà di forme e oggetti mentre imparano tutto su dimensioni e colori. Realizzato in legno massello e colorato con vernici atossiche. Sviluppa creatività, destrezza e capacità di ragionamento spaziale.



BB301

quadrati matrioska (in legno)



+3
ANNI



33035

set costruzioni "archi e triangoli"
(in legno)



+3
ANNI

37
PEZZI

33036

set costruzioni "parallelepipedi"
(in legno)



+3
ANNI

21
PEZZI



Gioco del martello

58578

118 sagome (in legno)
+ tavola in sughero e accessori



+3
ANNI

119
PEZZI

cm.20x20

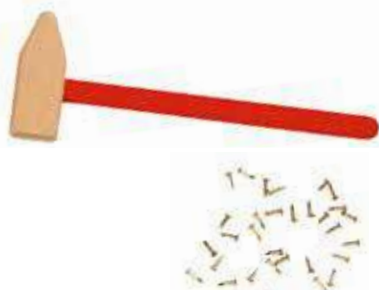

470 Logica, matematica e sperimentazione

Geopiano

Piano plastico dotato di pioli che consentono di realizzare forme geometriche o disegni con il supporto di elastici, cordoncini, ecc...

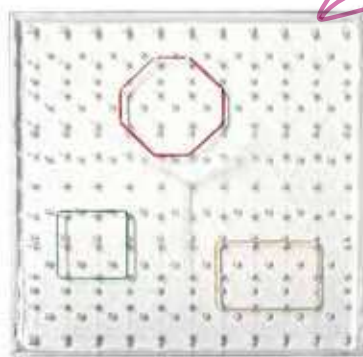

Utilizzabile da entrambi i lati!

09599

geopiano double-face trasparente



+6 ANNI

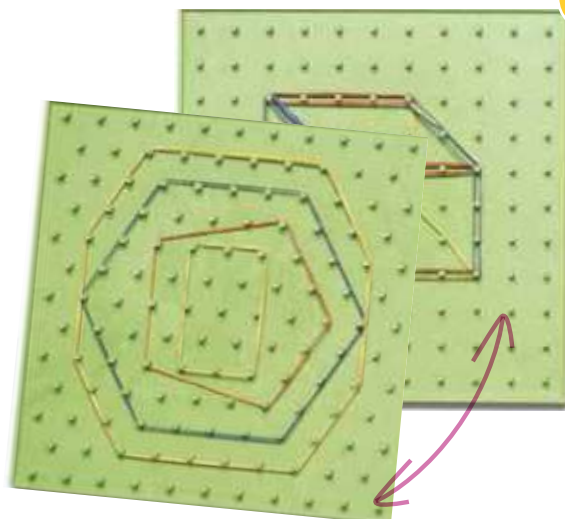

09597x4

geopiani trasparenti



+6 ANNI

4 PEZZI

09598x4

geopiani trasparenti



+6 ANNI

4 PEZZI

1530

geopiano double-face



+6 ANNI

Box tattile

11607

box tattile (in legno)

Il set include forme geometriche assortite, tre orsetti, istruzioni



+3 ANNI



Il box tattile favorisce lo sviluppo del vocabolario dei bambini e la conoscenza delle forme geometriche. Grazie ad esso i bambini possono scoprire e descrivere le caratteristiche delle forme geometriche, operare raggruppamenti, classificare per forma, spessore e dimensione.



Metro cubo e metro quadro

Il modo più pratico e concreto per insegnare ai bambini concetti piuttosto astratti e difficili come per esempio profondità, superficie, tridimensionalità.



09106x12

12 giunti a 2 vie

09107x12

12 giunti a 3 vie

09108x12

12 giunti a 4 vie

09109x6

6 giunti a 5 vie

09110x12

12 giunti

09111x12

12 piedini

09113x6

6 trafilati quadrati

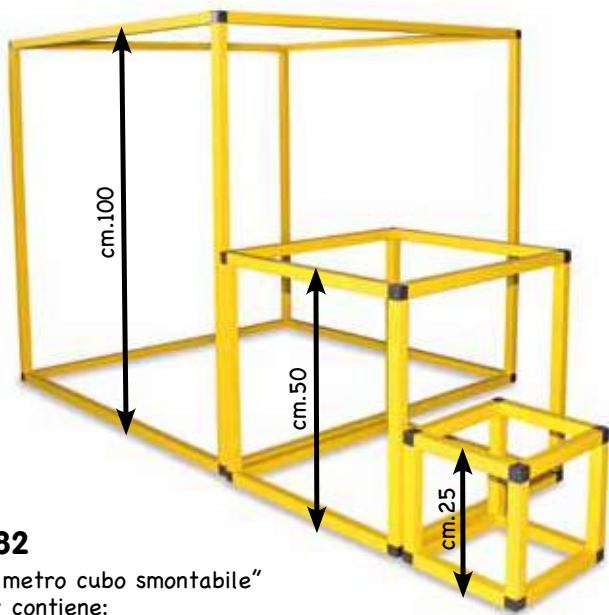

09182

"tris metro cubo smontabile"
il set contiene:

1 metro cubo (cm.100x100x100)

1 ottavo (cm.50x50x50)

1 sessantaquattresimo (cm.25x25x25)

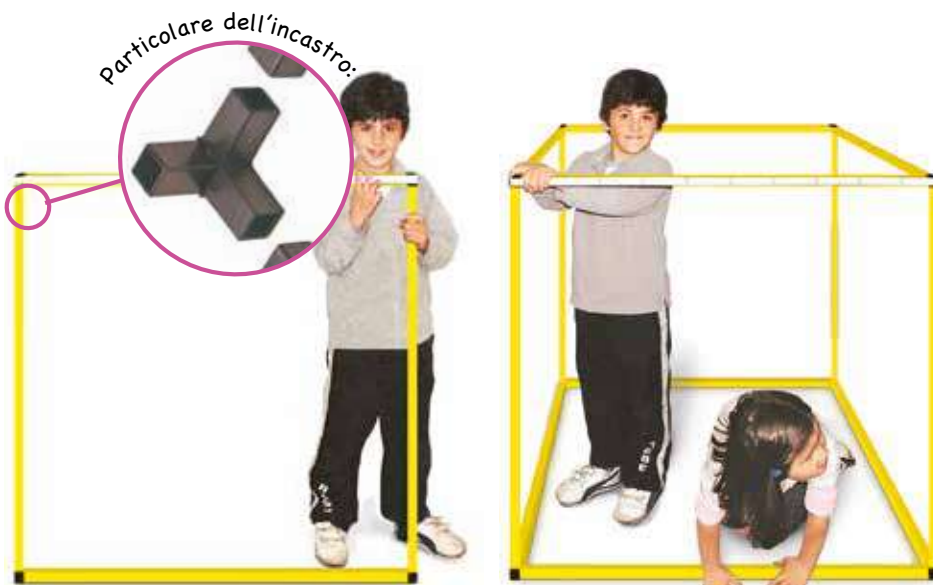

31

metro quadrato smontabile
(in plastica)



32

metro cubo smontabile
(in plastica)



Ruota metrica



08886

ruota metrica



Dotata di un pneumatico che ne garantisce la durata e la precisione. Il puntatore sulla ruota e il contatore aiutano i bambini a misurare le distanze intermedie. Ideale per calcolare distanze e superfici. Impugnatura regolabile.

Sistemi di misurazione



07673

07675

07677

07670

07671

TERMOMETRI: servono per misurare la temperatura di un ambiente attraverso la rilevazione della pressione atmosferica.

TERMOMETRO DI MASSIME E MINIME (07677): questo speciale termometro rileva la temperatura massima e quella minima della giornata. Grazie al pulsante posto al centro del termometro è possibile azzerare, per cominciare una nuova rilevazione!

07673

termometro da parete testa tonda



07675

termometro da parete (in legno)



07677

termometro massime/minime con azzeratore



07670

termometro in (alluminio)



07671

termometro in (alluminio)



BAROMETRO: basandosi sulla pressione atmosferica, fornisce utilissime previsioni sull'andamento del tempo.

IGROMETRO: serve per misurare il grado di umidità dell'aria, ossia il rapporto tra la quantità di vapore acqueo presente nell'atmosfera in un determinato istante e la quantità massima di vapore acqueo che può essere presente a una determinata temperatura e pressione.



07679

igrometro \varnothing cm.6,8



07678

barometro \varnothing cm.8



NOVITA'

12932

bussola tascabile \varnothing cm.45



07709

pluviometro graduato \varnothing cm.9x22
gradazione da 0,5 a 6 mm

Consente di misurare con estrema precisione la quantità delle precipitazioni atmosferiche, in particolare della caduta della pioggia, in relazione alla velocità di caduta. Dotato di coperchio.



05814

bilancia con vaschette trasparenti + 24 orsetti assortiti
(gli orsetti hanno un peso proporzionale tra loro: papà gr.12, mamma gr.8, orsetto gr.4)



Bilancia in plastica, dotata di due capienti vaschette trasparenti che, grazie ai coperchi inclusi nella confezione, si trasformano all'occorrenza in piatti piani. Ideale per insegnare ai bambini concetti legati a peso, equivalenze, comparazioni facendo loro pesare cibi, oggetti, liquidi...

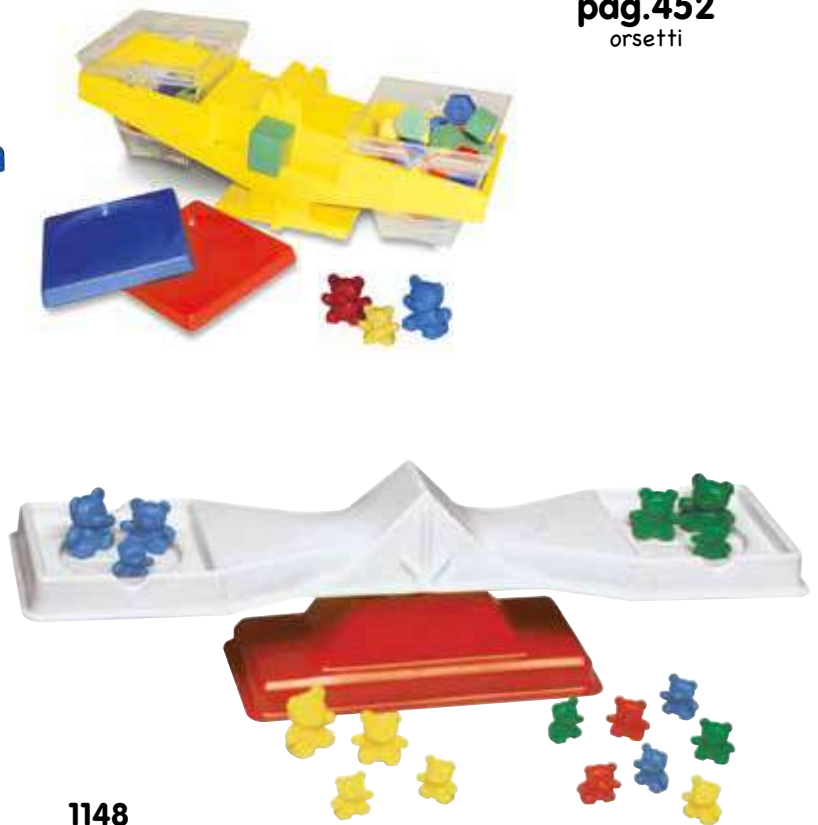

1148

bilancia ad altalena + 24 orsetti assortiti + istruzioni. Utilizzata per l'insegnamento delle prime nozioni di peso, equivalenze e comparazioni



05466

bilancia solidi/liquidi
Contenuto: 1 bilancia, 2 vaschette,
11 pesi in metallo, 14 pesi in plastica



Una bilancia pratica e molto precisa, dotata di due capienti vaschette trasparenti che possono essere riempite con solidi o liquidi e che, grazie ai coperchi inclusi, si trasformano all'occorrenza in piatti piani. Il set include anche 25 pesi assortiti in metallo e in plastica.



05813

bilancia multifunzione
+ 48 orsetti e perle forate

 **+6 ANNI**
CM.64,5x35x20

Bilancia che si trasforma in abaco! Il set è racchiuso in una vaschetta trasparente che contiene tutto il necessario per montare la bilancia (piatti, bracci, base) e per trasformarla in abaco (asticelle, perle forate). È possibile realizzare due diversi tipi di abaco: uno classico, composto da due basi separate, e un abaco/bilancia. Ideale per insegnare in modo pratico e divertente concetti matematici molto importanti quali peso, equivalenze, addizioni e sottrazioni.

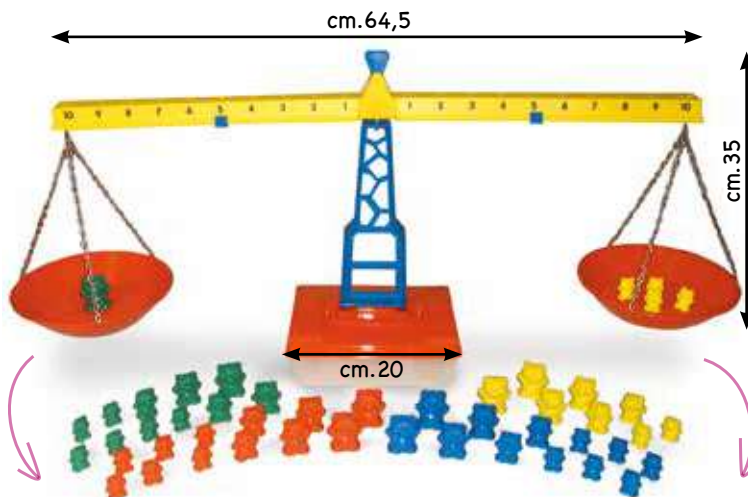

05465

bilancia matematica
+ 20 pesi

 **+6 ANNI** **21 PEZZI**
CM.65,5x19,5

Indispensabile per l'insegnamento delle operazioni matematiche fondamentali e di importanti concetti come il peso e la comparazione. La bilancia è dotata di display numerato.

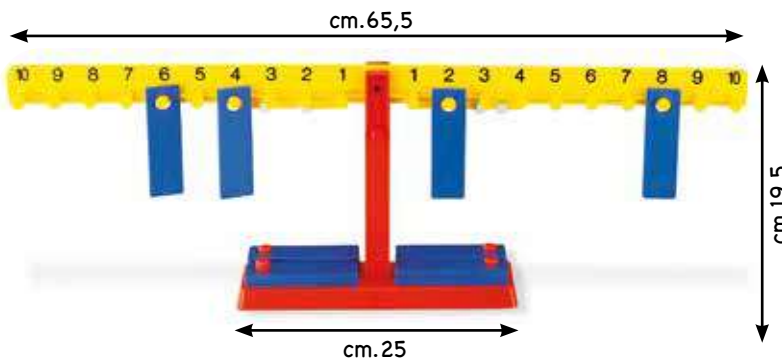

Pesi per bilance



05815

set pesi per bilancia (in plastica)
assortiti in 4 colori e 4
grammature: gr.1 - 5 - 10 - 20

+6 ANNI **54 PEZZI**



05468

set pesi per bilancia (in plastica)
include: 16 pesi da gr.20, 20 pesi da
gr.10, 20 pesi da gr.5, 20 pesi da gr.1

+6 ANNI **76 PEZZI**



05467

set pesi per bilancia (in metallo)
include: 1 peso gr.50 - 2 pesi gr.20 - 2 pesi
gr.10 2 pesi gr.5 - 2 pesi gr.2 - 2 pesi gr.1

+6 ANNI **11 PEZZI**

Barattoli e flaconi

Tante forme e differenti
capienze per soddisfare
ogni esigenza e per fare
ogni tipo di esperimento.



11845

100 barattolini ml.20
ø cm.4,4 x 2,5 h



12317

10 flaconi ml.50



11816

5 flaconi ml.30
con pipetta



10240

15 flaconi ml.80
con tappino antirovescio
di sicurezza e tappo
con pennello



11815

5 flaconi spray ml.100



11844

100 scatoline ml.40



08405x12

12 barattolini ml.33



11425x12

12 barattolini ml.60



11453

10 pipette dosatore ml.3



08410x12

12 flaconi ml.25



08411x12

12 flaconi ml.60



08412x12

12 flaconi ml.120



08416x12

12 flaconi ml.120
con tubetto



08406x12

12 barattoli ml.150



08407x12

12 barattoli ml.250



08408x12

12 barattoli ml.350



08409x12

12 barattoli ml.700



11997

flacone ml.500



09576

FLACONE ML.1000



08429x10

10 flaconi ml.1000



08415x12

12 flaconi ml.1000

Imbuti

05512

set 4 imbuti
misure assortite



Tubetti per esperimenti

Tubetti trasparenti resistenti e molto flessibili, perfetti per far capire nel modo migliore i concetti di capacità, misurazione dei liquidi ecc...

08199

tubetto in vinile morbido

 **+6 ANNI**
Ø MM.6,5x10 MT.

08201

tubetto in vinile morbido

 **+6 ANNI**
Ø MM.8,5x100 MT.

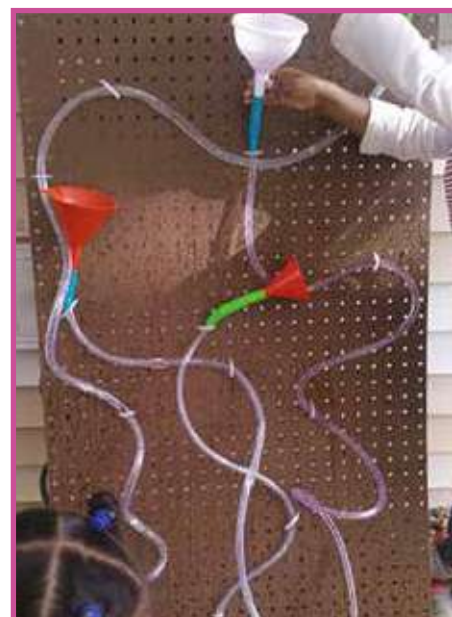

Recipienti graduati

pag.669
carrello
acqua e sabbia



05513

set 5 recipienti graduati
capacità: ml.100, 200, 300, 500, 1000

Recipienti in materiale acrilico, dotati di beccuccio. Su ogni brocca sono riportate le gradazioni in decilitri e in frazioni di litro.



Esperimenti con l'acqua

Questo set realizza il desiderio dei bambini di sperimentare con l'acqua. Con mezzi molto semplici potete mostrare loro che il ghiaccio galleggia sull'acqua, come cambia la temperatura dell'acqua durante un processo di scioglimento, l'effetto dell'acqua salata sulla galleggiabilità di un oggetto... Gli esperimenti da fare sono infiniti!

Contenuto: 5 brocche graduate, 8 provette, 5 imbuto, 5 pipette, 5 siringhe, tubo da 5 metri, 3 termometri, 9 tappi di sughero, 2 basi per provette. Totale 43 pezzi.

In materiale acrilico dotati di pratico beccuccio. Ogni cilindro ha una capacità differente dagli altri (ml.10, 25, 50, 100, 250, 500 e 1000).

05812

set cilindri graduati

+6
ANNI

7
PEZZI

NOVITA'

12893

"Esperimenti con l'acqua"

+6
ANNI

43
PEZZI



478 Logica, matematica e sperimentazione

Recipienti graduati

NOVITA'

12879

set 10 recipienti graduati
capacità:

A - 1 cilindro ml.50

B - 1 cilindro ml.100

C - 3 recipienti graduati
con manico
ml.500, 1000, 2000

D - 5 recipienti graduati
ml.50, 150, 250, 500, 1

+6
ANNI

10
PEZZI



SPERIMENTAZIONE



08288

cilindro graduato ml.600

Prodotto in materiale acrilico trasparente.
Con gradazione ogni ml.50



05811

cubo graduato

CM.10x10x10

+6
ANNI

In materiale acrilico infrangibile. Dotato di coperchio che consente di riempire il recipiente. Sul cubo sono riportate le varie graduazioni in modo chiaro e ben visibile.

Solidi geometrici

parallelepipedo:

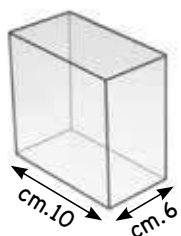

cubo:

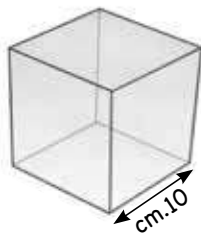

cilindro:

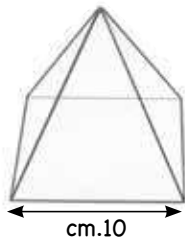

cono:

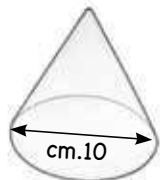

sfera:

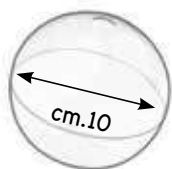

piramide:

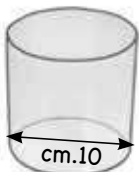

05462

set solidi geometrici trasparenti

CM.10 H

+6
ANNI

6
PEZZI



Piccolo giardiniere

Vasetti, sottovasi in materiale plastico antiurto per la sicurezza del bambino, e un piano di lavoro in materiale acrilico per svolgere giochi creativi o lavoretti di giardinaggio in totale sicurezza. I materiali dei vasetti si adattano a ogni tipo di decorazione.

12234

12 vasetti color terracotta
 ø cm.4 (6 pz.) + ø cm.5 (6 pz.)

12276

4 vasetti ml.250
 color terracotta

12272

12 sottovasi ø cm.7

12273

12 sottovasi ø cm.9

10561

vassoio cm.33x45
 in materiale acrilico

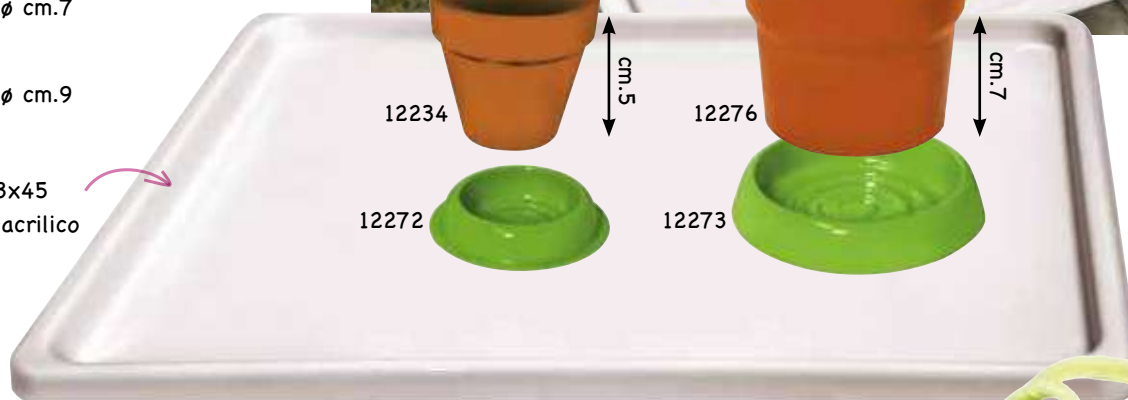

NOVITA'

12909

annaffiatoio 0,45 Lt
 (Realizzato con plastica riciclata al 100%)



BJ279

borsa con attrezzi per giardinaggio
 (in metallo e legno)

CM.28x24x13
 BORSA

+3
 ANNI

5
 PEZZI

BJ297

attrezzi per giardinaggio
 (in plastica)

CM.6x3x20
 ATTREZZO

+2
 ANNI

3
 PEZZI



pag.616
 carriola

Torba

Pastiglie di torba compresse 100% biodegradabili, certificate per coltivazioni organiche. E' sufficiente aggiungere acqua, e si ottiene una terra pura pronta per la coltivazione. Le pastiglie hanno un'ottima traspirabilità e non assorbono l'umidità in eccesso.



NOVITA'

12930

pastiglie torba \varnothing mm.36
confezione 36 pz

NOVITA'

12929

mini-serra con coperchio
+ 12 pastiglie torba cm.27x12



NOVITA'

12928

vasetti torba \varnothing cm.6 - confezione 20 pz



Tavolo coltivazioni



NOVITA'

12908

tavolo coltivazioni con coperchio
cm.78x37x79,5 h

Che siano pomodori, fagioli, insalata o basilico, questo orto con le gambe è abbastanza capiente per la coltivazione di erbe e piante. La copertura trasparente contribuisce a creare e mantenere il clima ideale per la crescita delle colture: infatti è dotata di un regolatore dell'aerazione con cui è possibile gestire la temperatura e il ricircolo dell'aria. Le gambe del tavolo sono cave all'interno e forate nella parte finale, permettendo all'acqua in eccesso di fluire all'esterno e non stagnare. Realizzato con plastica 100% riciclata infrangibile, resistente al gelo (-40°C) e ai raggi UV. Leggero e facile da spostare, questo tavolo può essere usato sia in ambienti chiusi che all'aperto.



Kit per coltivazioni

Una mini-serra per coltivare le piante con facilità! È possibile posizionarla sia in luoghi chiusi che all'aperto. Il coperchio (dotato di prese per la ventilazione dell'aria) crea e mantiene il clima ideale per la corretta crescita delle piante.

Il kit include: vassoio per la semina, sottovaso, coperchio, cartellini per piante. Realizzato con plastica 100% riciclata.



NOVITA'

12906

kit coltivazione da tavolo
con coperchio cm.40x30x20 h

Esplora il sottosuolo

C'è gran fermento sottoterra!

Questo terrario trasparente offre ai bambini l'opportunità di guardare tutto: radici che spuntano e crescono in varie direzioni, o vermi che si fanno strada attraverso la terra, smuovendola e ossigenandola. Basta riempire la scatola con terriccio, aggiungere semi (es. fagioli) e vermi e coprire il terrario con l'apposita protezione antiluce: infatti solo al buio le radici e i tunnel dei vermi raggiungeranno la parete di plastica, rendendosi più visibili. La copertura antiluce deve essere rimossa solo a scopo di osservazione!

Contenuto: scatola di plastica con basi d'appoggio, coperchio con prese d'aria, copertura antiluce in cartone.



NOVITA'

12892

"Esplora il sottosuolo"
contenitore cm.30x19x4

Vasi

Una gamma di articoli per insegnare ai bambini come nasce e si sviluppa una pianta. Il giardinaggio offre incredibili spunti da approfondire con gli studenti: come nasce una pianta? Di cosa necessita per crescere? Come la si coltiva? Quanto sono importanti le piante per l'ecosistema? Realizzati al 100% con plastica riciclata, garantiscono un incredibile rapporto qualità/prezzo e una lunghissima durata. Resistenti al gelo e ai raggi UV.

NOVITA'

12904

vaso estraibile cm.50x35x36 h

Questi vasi possono essere impilati l'uno sull'altro per creare un vero bosco verticale. Le piante crescono in modo ottimale perché ricevono abbastanza aria e luce e perché l'acqua in eccesso non ristagna grazie ai fori di drenaggio. Semplici da usare: basta incastrare un vaso sui bordi di quello sottostante, nella direzione che più preferite (diverse possibilità di incastro!).



NOVITA'

12905

vaso estraibile per patate e bulbi cm.32,3x25,7 h

Composto da un vaso interno e uno esterno. I semi dei bulbi vanno piantati nel vaso interno, che si può sollevare per seguire tutte le fasi della crescita. Quando le patate sono abbastanza grandi, potete raccogliergle rimuovendo il vaso interno. Questo vaso protegge il terriccio da muffe e malattie e assicura una produzione di patate anno dopo anno.



Cartellini per vasi

Un accessorio indispensabile durante la fase di semina e di raccolta. Grazie a questi cartellini in plastica riciclata è possibile contrassegnare e riconoscere subito le specie che si stanno coltivando. Scrivibile sia con marker indelebili che con marker cancellabili (questi ultimi consentono di riutilizzare i cartellini).



NOVITA'

12907

cartellini in plastica per vasi
5 pezzi - cm-6,3x 12,5

Esplorare la natura

Questa scatola consente di osservare la vita di piante e insetti, sia di terra che d'acqua, grazie alla potente lente di ingrandimento incorporata nel coperchio. La scatola è inoltre dotata di una lente d'ingrandimento mobile con luce a LED, per seguire con attenzione gli insetti in movimento. Il coperchio è dotato prese d'aria (per far respirare gli insetti) e di una maniglia per il trasporto.



NOVITA'

12889

"Esplorare la natura"
box con lente di ingrandimento
cm.116x9,5x10,5

Lenti d'ingrandimento

12015

lente d'ingrandimento "Bug Viewer" doppia osservazione
dimensione cm.20x14x13 - ingrandimento lente 3x

Questa bidirezionale lente d'ingrandimento consente di visualizzare un oggetto da due angolazioni differenti, superiore e laterale. Piccoli oggetti come insetti, erba e foglie possono essere collocati nel vassoio e visualizzati da entrambi gli angoli. Inoltre, due persone possono visualizzare un oggetto nello stesso momento.



DOPPIA
OSSERVAZIONE!



12016

lente d'ingrandimento "Bug Viewer"
con contenitore e tracolla
dimensione cm.14x7,5x10,5 - ingrandimento lente 4,5x

Gioco educativo per bambini, facile da trasportare grazie alla tracolla che può essere facilmente rimossa.



06425

lente d'ingrandimento "Bug Viewer"
con contenitore ø cm.7x7 h

Il coperchio è una lente a 3 strati completamente trasparente, che ingrandisce fino a 2 volte la grandezza naturale. Girando la lente superiore si ottiene un ingrandimento pari a 4 volte la grandezza naturale.

3X

6X

Osservare gli insetti



NOVITA'

12890

"Osservare gli insetti"

set 2 contenitori

cm.14,4x21x13 e cm.11,5x17,5x11

Un modo pratico e originale per far conoscere ai bambini varie specie animali: formiche, cavallette, lumache, grilli, mosche vespe, lombrichi... Tutto ciò che striscia, volazza o si arrampica in giardino! Ideale anche per piccoli animali acquatici! Sul coperchio di ogni scatola è presente una finestra di osservazione che può essere aperta, prese d'aria e una maniglia per il trasporto.



La vita nell'acqua

Perfetto per osservare la vita di piante e insetti, sia di terra che d'acqua, grazie alla potente lente di ingrandimento incorporata nel coperchio. Il fondo del secchiello presenta una griglia di 5 mm che consente di misurare la grandezza dell'insetto.

NOVITA'

12888

"La vita nell'acqua"

secchiello cm.9,5x18 h

con lente di ingrandimento



Formicaio

Una vera e propria stazione di osservazione delle formiche e di altri insetti.

Riempite di sabbia il recipiente di osservazione, mettete il contenitore di raccolta vicino a un formicaio e... Non passerà molto tempo prima che le formiche inizino a entrare nel tubo e incamminarsi verso la scatola trasparente del tutto volontariamente. La stazione di osservazione aggiuntiva, che include una lente d'ingrandimento a 2 vie e un paio di pinzette, serve per esaminare più da vicino animali e piante.



NOVITA'

12891

formicaio con strumenti di osservazione
cm.20,5x9x17,5

Ciclo della vita

... Indipendentemente dal fatto che gattonano, volino, nuotino o saltino, questi sei animali hanno una cosa in comune: la loro origine risiede in un uovo. I modelli per comprendere le fasi dello sviluppo mostrano in quattro o cinque fasi come si sviluppano i diversi esseri viventi.



NOVITA'

12897

"Ciclo della vita"
TARTARUGA MARINA
in plastica - cm.6,2x6,6x2



NOVITA'

12898

"Ciclo della vita" RANA
in plastica - cm.6,2x6,6x2



NOVITA'

12899

"Ciclo della vita" RANA
in plastica - cm.6,2x6,6x2



NOVITA'

12900

"Ciclo della vita" FARFALLA
in plastica - cm.6,2x6,6x2

Lente d'ingrandimento



BJE0023

tavoletta in legno cm.25x16x1,5
(lente sulla superficie più grande ha potere 3x
e le lenti sulle superfici più piccole 5x)



NOVITA'

12887

set 8 lenti di ingrandimento con
capacità di ingrandimento 5x
cm.9,8x4,2 ø - colori assortiti



NOVITA'

BJE0170

binocolo cm.12,5x10x5

Realizzato in plastica colorata, molto semplice da usare. Non necessita di messa a fuoco. Leggero e resistente, è perfetto per i giovani esploratori. Completo di tracolla con dispositivo di sicurezza a strappo.



Caleidoscopio

15310

caleidoscopio MAGICO (in plastica)
fondo marino con top girevole "effetti ottici"
dimensioni: ø cm.3,5x15,5

Super calamite



07875

8 super calamite mm.20x5 ø
Ideali per insegnare ai bambini in modo divertente i primi concetti di geometria, discriminazione ecc... Le super calamite si prestano a svariati giochi didattici: i cilindretti magnetici incuriosiscono i bambini proprio per la loro caratteristica di restare "magicamente" attaccati tra loro.

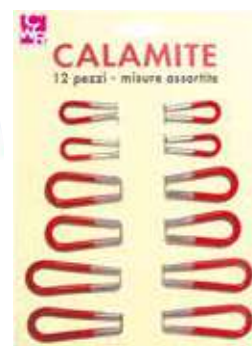

04673

set 12 calamite
dimensioni assortite:
cm.2x4,5 - 4 pezzi
cm.3x6 - 4 pezzi
cm.3x7,5 - 4 pezzi

Classiche calamite utilizzate anche come supporto didattico nelle scuole per insegnare ai bambini le prime nozioni di gravità e magnetismo.

Specchi deformanti

Magici specchi che faranno divertire i bambini delle scuole materne ed elementari. Curvando lo specchio e muovendosi davanti ad esso, infatti, i bambini si vedranno di volta in volta più alti, più bassi, più magri, più grassi... Materiale acrilico infrangibile, antisceggiata.



07165

specchio cm.14x25

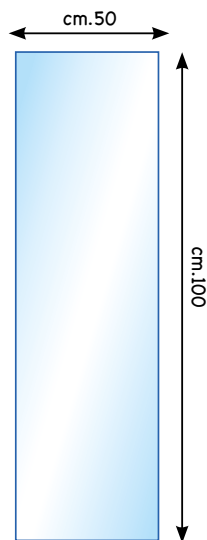

05517

specchio cm.50x100



Gioco degli specchi



07152

gioco degli specchi base cm.23x23

contiene: 7 tessere policrome, 3 specchi in materiale infrangibile, varie forme. A seconda di come verranno posizionati gli specchi e le forme geometriche e di come verranno sovrapposte le tessere policrome il bambino potrà assistere a un affascinante gioco di moltiplicazioni, effetti visivi dovuti alle immagini riflesse, cambiamenti di colore...

Reflect view



03617

Reflect View cm.10,5x15,5

Permette al bambino di imparare concetti come la simmetria, le trasformazioni, le congruenze, semplicemente osservando, muovendo, ricalcando o colorando l'immagine riflessa.

Test dello specchio



07159

set "Test dello specchio" (in legno)
cm.18x25x22 h

Un foglio di carta bianco viene inserito nella scatola, cosicché sia visibile dall'alto attraverso lo specchio, fabbricato in materiale infrangibile. Il bambino deve provare a riprodurre i disegni forniti dall'insegnante (che sceglierà disegni con vari gradi di difficoltà) ma... guardando la sua mano solo attraverso lo specchio, poiché essa è nascosta dall'apposita protezione!!! Attraverso l'apertura sul retro i partecipanti al gioco possono controllare passo passo come si sviluppa la creazione dell'artista, che può vedere il suo operato solo "al contrario" attraverso lo specchio.

Specchio del pittore



07893

set specchio del pittore (in legno) cm.50x60
Il set contiene 2 marker cancellabili,
1 cancellino, 1 bicchiere e 2 pennelli

Specchio in materiale acrilico, infrangibile e antisceggia, montato su una solida base di legno con bordi e spigoli arrotondati che consente di appoggiare il gioco sul banco o su un tavolo. Con questo specchio il bambino può vedere la sua immagine riflessa e - con il supporto di colori a dita, tempere, pennarelli per lavagne, pennelli, spugnette - cercare di realizzare un autoritratto. Facilmente lavabile con un panno inumidito.

Finestra per ritratti

07819

set finestra trasparente per ritratti (in legno)
cm.50x60. Il set contiene: 2 marker cancellabili,
1 cancellino, 1 bicchiere e 2 pennelli

Osservando un compagno di classe, seduto dall'altra parte dello "specchio trasparente", il bambino deve cercare di realizzarne il ritratto sulla finestra, utilizzando marker, colori a dita o tempere. In questo modo il bambino inizia a prendere confidenza con lo schema corporeo. Un'idea in più: quando il colore è ancora umido e il bambino ha terminato il ritratto, potete appoggiare un foglio di carta sulla finestra plastica, in modo da imprimere il capolavoro! I colori a tempera possono essere facilmente eliminati dalla finestra utilizzando una spugna inumidita.



Programma educativo



AREE DI SVILUPPO:

| | | |
|--|--|---|
| Sviluppo cognitivo e dei concetti numerici. | Sviluppo socio-emozionale. | Sviluppo motorio e sviluppo delle capacità di scrittura. |
| Sviluppo creativo. | Percezione tattile. | Sviluppo linguistico e sviluppo delle capacità di lettura. |
| Sviluppo della percezione di forme e colori. | Sviluppo della personalità e dell'abilità di fronteggiare le situazioni. | Orientamento nello spazio e nel tempo e orientamento nel mondo. |

Concepta +2° Diagramma dei concetti

Concepta incoraggia i bambini a fare osservazioni visive e associazioni logiche. Il gioco consiste in 6 diversi compiti di coordinazione, e ogni compito riguarda un diverso tipo di organizzazione. Ciascun compito richiede l'utilizzo di due strisce di coordinazione e di 16 carte-concetto. Strisce e carte devono avere il bordo del medesimo colore. Il bambino sceglie un colore e prende tutte le carte-concetto e le strisce che hanno il bordo di quel colore.

09318

Contenuto:
2 tavole, 12 strisce di coordinazione,
96 carte, manuale d'uso

AREE DI SVILUPPO:



Gioco del dialogo - Vita quotidiana

I bambini potranno usare il linguaggio in modo spontaneo e creativo, familiarizzando con moltissimi concetti linguistici e aritmetici. Possono giocare da 2 o 3 bambini contemporaneamente.

09319

Contenuto:
5 schede a tema (stampate su entrambi i
lati), 1 piedistallo per le schede, 12 chiodini
colorati, manuale d'uso

AREE DI SVILUPPO:

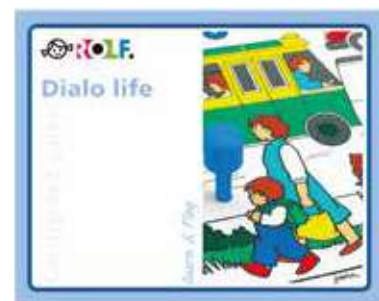

La borsa della spesa

Il gioco "La borsa della spesa" fa sembrare reale l'atto della spesa, specialmente quando si usano i frutti e le verdure in plastica (articoli 05188 e 05189, non inclusi nel gioco). Questo gioco stimola inoltre lo sviluppo della conoscenza dei numeri, e i bambini imparano come utilizzare le cifre fino ai dieci. Nel set troverete un assortimento di giochi numerici connessi all'attività della spesa. Utilizzabile da 2 fino a 4 bambini contemporaneamente. Età consigliata: a partire dai 4 anni.

09322

Contenuto:
1 disco in plastica con lancetta cm.20x20, 8 liste della spesa
in plastica cm.10x16, 3 cartellini prezzi in plastica cm.9x20,
40 carte in plastica con frutti e verdure cm.5x5.
Scatolina con 100 fiches, 3 dadi in legno, 1 foglio con adesivi
di frutti e verdure da attaccare sui dadi, manuale d'uso

AREE DI SVILUPPO:



490 Logica, matematica e sperimentazione

Gioco del dialogo - Tempo Libero

Questo gioco funziona esattamente come il precedente, ma i temi trattati riguardano il tempo libero. Temi delle schede situazionali e corrispondenti concetti chiave del gioco del dialogo - Tempo Libero.

09320

Contenuto:

5 schede a tema (stampate su entrambi i lati), 1 piedistallo per le schede, 12 chiodini colorati, manuale d'uso

AREE DI SVILUPPO:



Explora

Explora aiuta i bambini a comprendere meglio dei concetti e ad imparare a esprimerli a parole. I bambini eseguono il compito insieme, o a coppie. Per fare ciò devono spiegarsi, esprimersi, per poi controllarsi a vicenda. Con Explora l'interazione sociale e la stimolazione del linguaggio sono garantiti! Indicato per 2 bambini a partire dai 4 anni di età.

09321

Contenuto:

4 tavole gioco in plastica cm.32x25
4 schede gioco in plastica cm.32x6
4 schede gioco in plastica (autocorrettive) cm.16x12, un piedistallo per le schede, 16 chiodini in plastica assortiti in 8 colori, manuale d'uso

AREE DI SVILUPPO:

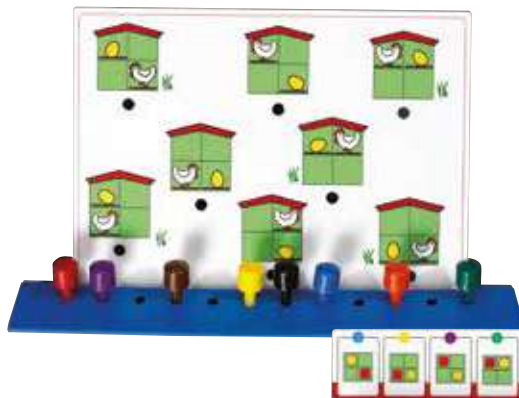

Gioco del Castello

Il gioco è composto da 2 giochi diversi. Lo scopo di entrambi è di sviluppare la comprensione delle quantità e dei numeri. Nel primo gioco, "Nella Foresta", vengono approfonditi i concetti di "più" e "meno". I bambini tirano il dado a turno: se la pedina si ferma su un tesoro il cavaliere vince delle monete; se invece si ferma su un dragone perde le sue monete: per sapere quante monete perde dovrà tirare il dado con puntini da 1 a 6. Vince il cavaliere che arriva al castello con il maggior numero di monete. Nel secondo gioco, "Spada e scudo", si introducono i concetti di equivalenze, divisioni, addizioni e sottrazioni. I cavalieri devono acquistare un nuovo equipaggiamento per il ballo al castello: vince il cavaliere che arriva al castello con l'armatura più completa e con più monete. Il gioco del Castello può essere utilizzato da 2 fino a 4 bambini a partire dai 5 anni di età.

09328

Contenuto: 2 tabelloni gioco cm.37x37, 100 gettoni in plastica (denaro), 24 carte raffiguranti l'equipaggiamento dei cavalieri cm.4,5 x 5, 4 carte di raccolta, stampate su entrambi i lati, 4 pedine, 2 dadi: puntini da 1 a 3 e da 1 a 6, manuale d'uso

AREE DI SVILUPPO:





Gioco simbolico e di immaginazione

Il gioco simbolico è il risultato dello sviluppo del pensiero astratto. Il pensiero astratto, e utilizzare simboli per rappresentare altre cose o concetti, sono il fondamento del linguaggio. Infatti le parole sono simboli astratti che rappresentano oggetti concreti, proprio come gli oggetti all'interno del gioco sono simboli astratti (ad esempio, un bastone usato per rappresentare una bacchetta magica).

Man mano che i bambini sviluppano la capacità di impegnarsi in giochi simbolici, di finzione e immaginazione, essi diventano in grado di pensare alle cose come separate dagli oggetti che rappresentano.

493 Cucine gioco

506 Bambole

519 Strumenti musicali

524 Libri per bambini

Cucina Linea EDU

Mobili in legno di alta qualità. Modulabili e affiancabili, così da poter creare il banco cucina della lunghezza desiderata.

+3
ANNI

cm.54



12228
microonde (in legno)

CM.35x26x24



12224
lavandino (in legno)

CM.40x35x54



12225
fornelli/forno (in legno)

CM.40x35x54



● **09928** pensile da appendere (in legno)

CM.40x24x34



12226
lavatrice (in legno)

CM.40x35x54



12227
frigorifero (in legno)

CM.40x35x54

Cucina completa di accessori

Cucina in robustissimo legno composta da lavandino, forno e piano cottura con manopole, pentole, utensili da cucina e ganci per appenderli!

BJ464

cucina completa di accessori (in legno)



+3 ANNI



COMPLETA DI VARI UTENSILI!

Stoviglie



07496

set utensili e pentolini (in metallo)



+3 ANNI 9 PEZZI

NOVITA'

BJ943

macchina del caffè

Inclusi nel set: 4 cialde caffè, tazza, cartone del latte. Tutto realizzato in legno di altissima qualità.



+3 ANNI 7 PEZZI



BJ620

servizio tè/caffè (in legno)

contiene una teiera con coperchio, 2 tazzine con piattini, zuccheriera con coperchio, 2 cucchiaini, un bicchiere per il latte e un vassoio



+3 ANNI 10 PEZZI

BJ617

set stoviglie (in legno) contiene 4 piatti, 4 bicchieri, 4 coltelli, 4 forchette e 4 cucchiari



+3 ANNI 20 PEZZI

494 Gioco simbolico e di immaginazione

Cucina

Realizzati in plastica di alta qualità con bellissimi colori vivaci. I kit possono essere utilizzati a contatto con il cibo. I piatti possono essere lavati in lavastoviglie e utilizzati nel microonde.



12836

stoviglie - set accessori cucina

CM.28x28x6

+1 ANNI

10 PEZZI



12837

stoviglie - set accessori per cucinare e informare

CM.19,2x14,8x9

+3 ANNI

18 PEZZI



24000

fornello (in plastica) completo di accessori

CM.33x25

+3 ANNI

1 PEZZI



● **GW45411**

servizio da tè

Ø CM.27 VASSOIO

+3 ANNI

18 PEZZI



12830

stoviglie - set caffè

CM.17x16x17

+1 ANNI

16 PEZZI



12831

stoviglie - set caffè/the per 4

CM.13x12,5x12,2

+1 ANNI

20 PEZZI

Pranzo / Cena



12832

stoviglie - vassoio pranzo/cena



+1
ANNI

34
PEZZI



12833

posate gioco (portaposate incluso)



+1
ANNI

17
PEZZI



05690

set bicchieri (in plastica)
ml.125 - colori assortiti
lavabile in lavastoviglie

+3
ANNI

12
PEZZI



12834

stoviglie - set pranzo/cena per 6



+1
ANNI

37
PEZZI



12835

stoviglie - set pranzo/cena



+1
ANNI

50
PEZZI



● **GW45437**

servizio da cena (in plastica)



+3
ANNI

40
PEZZI



12838

set picnic (in plastica)



+1
ANNI

17
PEZZI

Alimenti gioco

Fedeli riproduzioni dei prodotti alimentari più utilizzati in cucina. Ideali per rendere ancora più realistici i giochi d'imitazione e finzione! Incoraggiano il gioco creativo e fantasioso e contribuiscono allo sviluppo del vocabolario.



BJ437

set insalata (in legno)

36

PEZZI



BJ623

generi alimentari da dispensa (in legno)
Include: biscotti, bustine di tè, fagioli, pasta, cereali, riso e molto altro ancora!

11

PEZZI



BJ624

generi alimentari da frigo (in legno)
Include: succo di mela, marmellata, burro, formaggio, pesto, ketchup e altro ancora!

11

PEZZI

Torta di compleanno



NOVITA'

BJ628

torta di compleanno
Il set include 6 fette di torta, 6 candeline, un vassoio e un coltello. Tutto realizzato in legno di altissima qualità.

CM.18x10 H

+1
ANNI

14
PEZZI



Alimenti gioco

Indispensabili strumenti per i classici giochi di imitazione, queste fedelissime riproduzioni di frutti e verdure rendono ancora più divertenti e "reali" i giochi di scambio, compravendita, classificazione e distribuzione.



cm.19

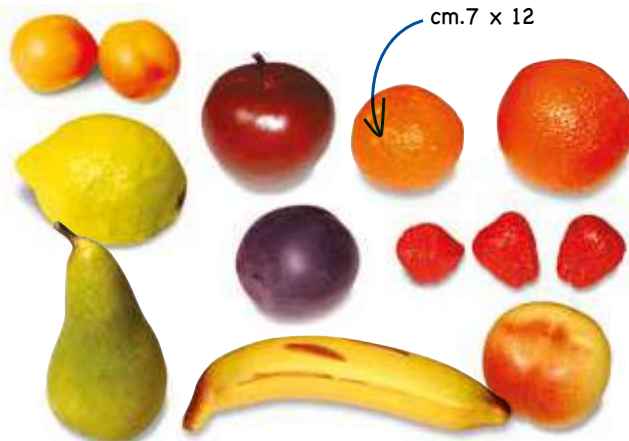

cm.7 x 12

05189

set di verdure (in plastica) contiene: 1 melanzana, 1 zucchini, 2 carote, 2 patate, 1 peperone, 1 pomodoro, 1 cipolla, 1 aglio, 1 cetriolo

+2
ANNI

11
PEZZI

05188

set di frutti (in plastica) contiene: 2 albicocche, 1 prugna, 3 fragole, 1 pesca, 1 banana, 1 pera, 1 mela, 1 limone, 1 mandarino, 1 arancia

+2
ANNI

13
PEZZI

Alimenti gioco in cassetta

Rappresentazioni di cibi in legno ideali per insegnare ai bambini: l'importanza di una dieta sana ed equilibrata, la provenienza del cibo e come si prepara. Questi set sono indispensabili per i giochi di imitazione nelle cucine gioco.

10220

cassetta con 12 verdure (in legno)



CM.16,5x12,5x7
CASSETTA

+2
ANNI

13
PEZZI

10221

cassetta con 12 frutti (in legno)



CM.16,5x12,5x7
CASSETTA

+2
ANNI

13
PEZZI

T0104

cassetta carne e pesce (in legno)



CM.15x12x5
CASSETTA

+2
ANNI

7
PEZZI



498 Gioco simbolico e di immaginazione

Alimenti gioco in cassetta

CM.18x14
CASSETTA

+2
ANNI



BJ474

cassetta del macellaio
(in legno)

8
PEZZI



BJ475

cassetta del pescivendolo
(in legno)

10
PEZZI



BJ476

cassetta del fruttivendolo
(in legno)

8
PEZZI



BJ477

cassetta dell'ortolano
(in legno)

10
PEZZI

**TAGLIA
la frutta**



BJ747

gioco "taglia la frutta"
(in legno)

10
PEZZI

**TAGLIA
la verdura**



BJ748

gioco "taglia la verdura"
(in legno)

10
PEZZI



Mercatino

Ideali per riprodurre la situazione del mercato e dunque per prendere confidenza con i nomi dei prodotti, il concetto di compravendita e interazione, il valore del denaro...



● **RA201**

banco del mercato in legno
(accessori esclusi)



06814

bancarella del mercato in legno
(accessori esclusi)



Mercatino/Teatrino

include tettoia rossa
per mercatino, tenda
e sipario per trasformarlo
in teatrino!



MERCATINO

TEATRINO



10402

mobile mercatino-teatrino (in legno)



500 Gioco simbolico e di immaginazione



08925
registratore di cassa (in legno)
 **+3**
 ANNI
 CM.27,5x23x14,5

BJ466
carrello per supermarket (in legno)
 **+3**
 ANNI
 CM.26x42x57



BJ467
bilancia (in legno)
 **+3**
 ANNI
 CM.11x14,5x22



R21610
salvadanaio (in legno) con lucchetto
 **+3**
 ANNI
 CM.17x13

Denaro



09868

barattolo 96 banconote EURO (fac-simile)
+ 112 monete

ASSORTITI +3 ANNI 208 PEZZI

I prodotti ideali per insegnare ai bambini la funzione del denaro e per far loro capire come si stabilisce il prezzo della merce e per insegnare a riconoscere e ad usare le varie banconote e monete.



05050

set scuola portaeuro
contiene: 1 vaschetta (in plastica) con 8 scomparti per le monete e 7 scomparti per le banconote, 144 banconote (fac-simile), 148 monete in materiale plastico ad uso didattico

CM.25x35 VASCHETTA +3 ANNI 293 PEZZI

05041

vaschetta portaeuro in plastica (monete e banconote escluse)

CM.25x35 +3 ANNI



05051

set monete EURO (in plastica)

ASSORTITI +3 ANNI 148 PEZZI



05052

set banconote EURO (fac-simile)

ASSORTITI +3 ANNI 144 PEZZI

09907

poster "Conosciamo l'EURO"

CM.50x70 +3 ANNI

502 Gioco simbolico e di immaginazione

Set Beauty

Il set è composto da 11 pezzi: flacone di crema, specchio, pettine, smalto per unghie, rossetto, profumo, asciugacapelli, cipria, fascia e 2 lacchetti per capelli, il tutto contenuto in un bellissimo beauty case con maniglia! Un ottimo modo per incoraggiare sessioni di gioco di ruolo creative e fantasiose. Utile per sviluppare le abilità sociali e linguistiche. Non contiene cosmetici!



BJ490

set BEAUTY (in legno)



+3 ANNI

11 PEZZI

pag.516
mobile dei travestimento

Valigetta del dottore

Un ottimo modo per incoraggiare sessioni di gioco di ruolo creative e fantasiose e per aiutare i bambini a capire il processo di andare a vedere il Dottore. Promuove le abilità sociali e linguistiche mentre i bambini parlano ai loro pazienti, discutendo sulla loro salute. Incoraggia il comportamento educativo e l'empatia.

Completa di molti accessori come:
1 stetoscopio
1 termometro
1 siringa
cerotti ecc...



T0407

valigetta del dottore (in tessuto)



+3 ANNI

9 PEZZI

Giochi per pulizie



BJ377

stendibiancheria (in legno)
con mollette



+3
ANNI



10774

carrello delle pulizie (in plastica)



+3
ANNI

5
PEZZI

Include: un carrello su ruote con un contenitore, una paletta con spazzola, una scopa e uno spazzolone. Il carrello, pratico e resistente, facilita il trasporto dell'intero contenuto.



07770 asse da stiro
(in legno)
+ ferro da stiro



+3
ANNI

2
PEZZI

BJ693

set per la pulizia (in legno)



+3
ANNI

5
PEZZI

CON 6 DISCHI MAGNETICI



33009

aspirapolvere (in legno)



+3
ANNI



15349

set per la pulizia (in legno)
scopa, scopina e paletta



+3
ANNI

3
PEZZI

504 Gioco simbolico e di immaginazione

Giochi per bambole



Completo di biancheria da letto!



T0213

carrozzina per bambole 3 in 1 (in legno)

CM.58x35,5x50 **+3 ANNI**



T0217

seggione per bambole (in legno)

CM.45x31x63 **+3 ANNI**



2 IN 1
trasforma
la tua culla
in un lettino

Completo di biancheria da letto!



T0212

culla per bambole 2 in 1 (in legno)

CM.53x40x34 **+3 ANNI**



T0145

culla a dondolo (in legno)

CM.53x36,5x28,5 **+3 ANNI**



07784

lettino in legno (materasso e cusino esclusi)

CM.54x29x25 **+1 ANNO**

51805

set letto per bambole (cuscino cm.10x22, trapunta cm.41x31, materasso cm.54x25)

ASSORTITI **+1 ANNO** **3 PEZZI**



Bambole con corpo rigido

Una serie di bambole articolate ricche di dettagli. Prodotti in vinile. I capelli sono cuciti e quindi non possono essere staccati.

Tutte le bambole
Sono profumate!

QUALITÀ EXTRA!!!



Bambola senza capelli

10268

europeo maschio

10269

europeo femmina

10270

africano maschio

10271

africano femmina



40
CM.



Bambola con capelli

10272

europeo maschio

10273

europeo femmina

10274

africano maschio

10275

africano femmina



40
CM.



Bambola con capelli

10276

europeo maschio



45
CM.



40
CM.

10282

coppia gemellini europei (maschio + femmina)



506 Gioco simbolico e di immaginazione

Bambola morbida

Questa bambola soffice e coccolona aspetta solo di essere amata! Una bellissima compagna di giochi per incoraggiare i processi di finzione e imitazione.

30
CM.



BJD016

bambola Katie



+1
ANNI



BJD509

abito righe azzurre cm.30



BJD526

abito rosa con cappello cm.30



Abiti per bambole

Adatti per bambole da cm.38 a 45. Lavabili. Vestire e svestire la bambola aiuta il bambino a migliorare le capacità manipolative. I modelli possono variare a seconda della disponibilità.



07019

scarpine per bambolotto



07018

intimo per bambolotto



10287

abito estivo per maschio



10288

abito estivo per femmina



10285

abito invernale per maschio



10286

abito invernale per femmina

Coppia bambole "Birbe"

20
CM.



10283

europeo (maschio + femmina)



+3
ANNI

2
PEZZI

20
CM.



10284

africano (maschio + femmina)



+3
ANNI

2
PEZZI

pag.381
il baule dei vestiti

Albero delle Stagioni

Un enorme albero che deve essere ricostruito su una parete. Ad ogni mutamento di stagione i bambini potranno divertirsi ad arricchire l'albero con fiori, frutti, foglie e tutti gli altri elementi contenuti nel set. Questo originale strumento didattico è molto utile per avvicinare il bambino al concetto di successione temporale.

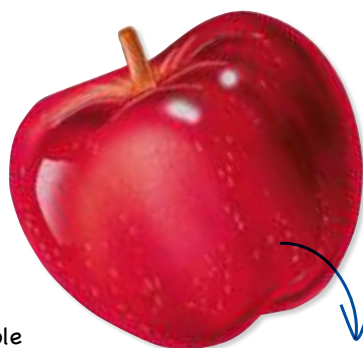

cm.10x10 circa

05917

albero delle stagioni
(in cartone pesante)
ingombro massimo: cm.250x250
(L'albero è costituito da 10 tavole
in cartone da assemblare)

IN CARTONE
cm.250x250

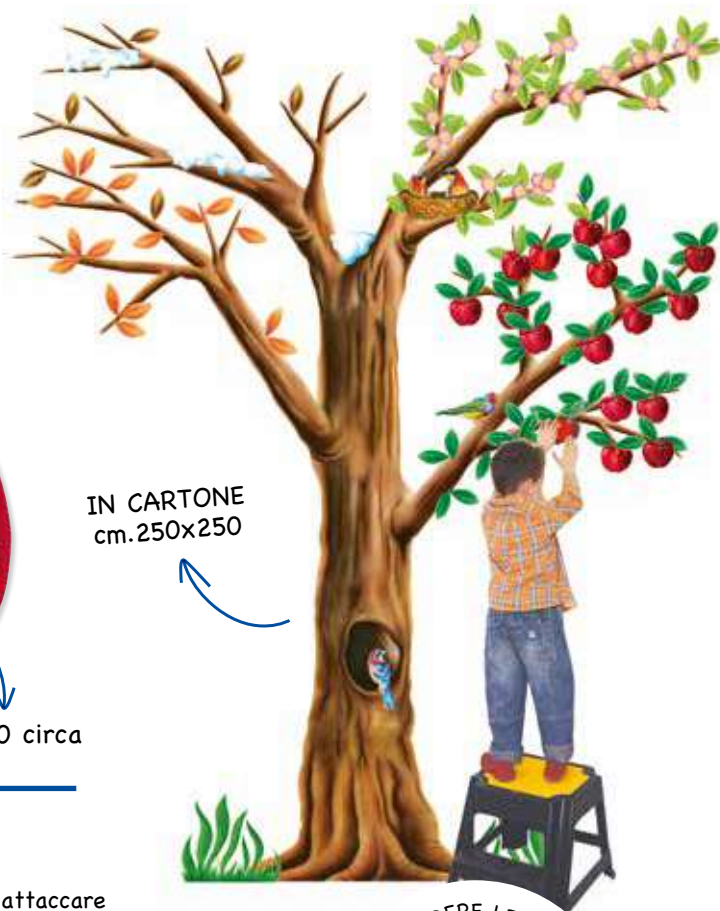

Le Stagioni della Quercia

La Quercia è disponibile in due versioni: una bidimensionale, da attaccare alla parete, e una tridimensionale, composta da due strutture a incastro, da posizionare sul pavimento. Entrambe le versioni sono in legno antiscivolo e dotate di forellini per facilitare il posizionamento di oggetti decorativi. Nelle confezioni sono inclusi quattro fogli, sui quali sono illustrati vari soggetti tipici di ogni stagione: i frutti, le rondini, i fiocchi di neve, le foglie ingiallite.

PIOLI PER APPENDERE LE DECORAZIONI!

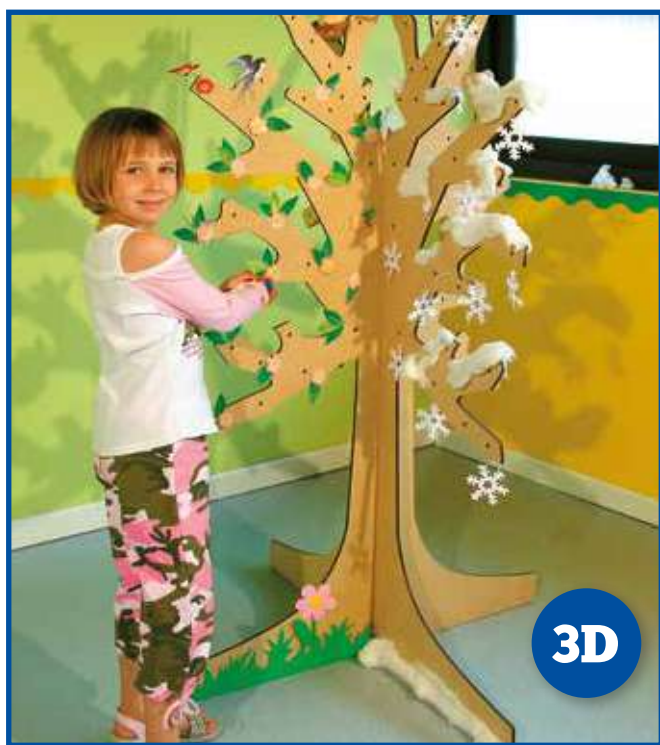

07515

quercia delle stagioni 3D da pavimento (in legno)
con 4 fogli elementi decorativi
Dimensioni: cm.75x75x120



07519

quercia delle stagioni da parete (in legno)
con 4 fogli elementi decorativi. Dimensioni: cm.70x145 h
La confezione include i pioli per appendere le decorazioni.

508 Gioco simbolico e di immaginazione

Grande Albero

Il grande albero in legno è perfetto per decorare l'aula: con i soggetti decorativi (art. 09635) lo si può adattare ad ogni stagione e con i dischetti in cartoncino (art.09292) può essere utilizzato come registro delle presenze.

12035

grande albero (in legno) cm.67x130 h spessore cm.0,7

NELLA CONFEZIONE SONO INCLUSI:

30 pioli per appendere decorazioni, 30 dischetti in cartoncino ø cm.8, 4 cartoncini cm.25x35 "le 4 stagioni" con soggetti decorativi da ritagliare e appendere e 30 dischetti in cartoncino per realizzare l'albero delle presenze



DISCHETTI IN CARTONCINO PER L'ALBERO DELLE PRESENZE



IN LEGNO
cm.67x130

PIOLI PER APPENDERE LE DECORAZIONI

fori per il fissaggio dell'albero a muro

Alberi

Prodotti in legno antisceggiia con forme arrotondate e prive di spigoli per garantire la massima sicurezza dei bambini. I grandi alberi possono essere fissati con facilità a pareti, staccionate, colonne eccetera. I bambini potranno poi decorare gli alberi con i loro disegni, magari rispettando il tema della stagione in corso. Disponibili nella versione in legno naturale, da decorare e dipingere, e nella versione già verniciata.

Dipingi gli alberi con i colori acrilici

OGNI ALBERO CONTIENE:

- 12 dischetti in velcro per attaccare e staccare con facilità l'albero sulle superfici lisce
- 4 cartoncini cm.25 x 35 "Le stagioni" con soggetti decorativi da ritagliare e attaccare
- 30 dischetti tondi portafoto
- 20 spinette per appendere le decorazioni



09202

melo (in legno)
cm.75x75 h spessore cm.0,6



09257

melo (verniciato)
cm.75x75 h spessore cm.0,6



09203

acero (in legno)
cm.75x150 h spessore cm.0,6



● 09258

acero (verniciato)
cm.75x150 h spessore cm.0,6

Dotato di forellini a cui appendere le decorazioni natalizie o stagionali.

OGNI ALBERO CONTIENE:

10 sagome in feltro con velcro stacca/attacca

30 dischetti tondi portafoto

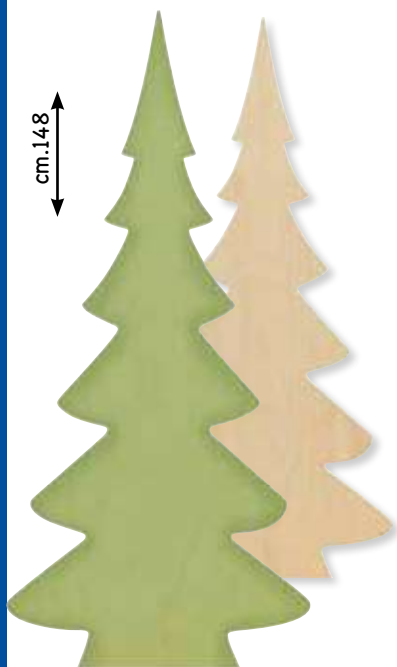

09200

09200

abete (in legno naturale)
cm.77x148 h spessore cm.0,6

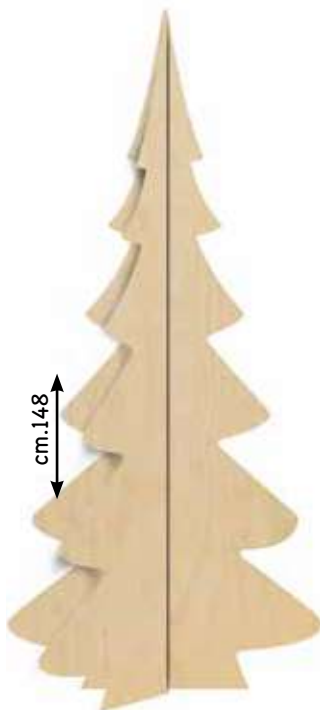

09201

abete doppio (in legno naturale)
cm.65x148 h - spessore cm.0,6



10250

albero decorativo (in legno)
cm.83x120 h

09653

abete (verniciato)
cm.77x148 h spessore cm.0,6

Soggetti in legno

Questi soggetti in legno sono ideali per arredare aule, corridoi, staccionate...

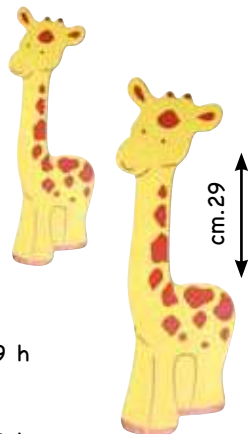

09265

giraffa cm.9x29 h

09266

giraffa cm.7x24 h



09286

cane e gatto cm.22x35 h circa



09287

erba cm.20x74 h circa



09288

set 2 fiori cm.23x35 h



09289

funghi cm.23x35 h + farfalla

Soggetti da ritagliare

Ideali come decorazioni per gli alberi

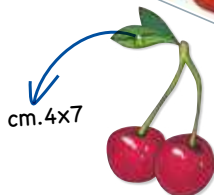

12052

set 4 cartoncini cm.35x50
"Le 4 stagioni" con soggetti
decorativi da ritagliare e
attaccare agli alberi

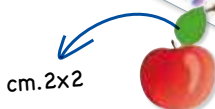

09685

set 4 cartoncini cm.25x35
"Le 4 stagioni" con soggetti
decorativi da ritagliare e
attaccare agli alberi

Dischetti



09292

set da 30 dischetti
(in cartoncino)
dimensioni: ø cm.8

Cestini per raccolta differenziata

Robustissimi recipienti per la raccolta differenziata, dotati di un pratico anello che blocca il sacchetto dell'immondizia e lo fa aderire perfettamente al cestino. La confezione include 4 cestini nei 4 colori istituzionalmente stabiliti per la raccolta dei vari materiali: verde per il vetro, blu per carta e cartone, giallo per gli imballi plastici, marrone per i rifiuti organici / umidi.



08744

cestini assortiti per la raccolta differenziata
+ anello fermasacchetto ø cm.30



4
PEZZI

Ø CM.27,5x32



08917

carrello portacestini con 4 ruote (in legno)

08918

set carrello portacestini (in legno)
con 4 ruote, 4 cestini + 100 sacchi neri per rifiuti (capacità 25 lt.)



1
SET

CM.50x60
SACCHI

Maschere da decorare

Fabbricate in materiale acrilico, supportano la maggior parte dei collanti e costituiscono un'ottima base per moltissimi tipi di colore. I bambini potranno divertirsi a dipingere la propria maschera e decorarla con carta, cartoncini, glitter, capelli finti... Le maschere possono anche essere utilizzate come stampi per ceramica a colata e per gesso o come calchi per cartapesta.



06344

busta cordoncino elastico
ø mm.1x3 mt.



1340

maschera donna
cm.14x20



1340/1

maschera uomo
cm.15x23



05615

maschera donna
cm.15x21



● **2780/6**

maschera sole/luna cm.21x23

2782/1

maschera sole/luna cm.29x38



08445

maschera sole
cm.25x27



08447

maschera Colombina cm.16x12

08446

maschera Colombina cm.21x15



05616

maschera bimbo/clown
cm.15x20



05617

maschera indiana
cm.20x27



05618

maschera greca
cm.20x27



05619

maschera leone
cm.22x26



1340/2

maschera "Maya"
cm.19x35



05054

set maschere di carnevale
contiene: 2 maschere
da decorare,
6 colori acrilici,
1 pennello,
1 elastico



05494

set completo per maschere
contiene: 8 maschere, 6 cartoncini
pesanti colorati per creare i dettagli del muso,
cartamodelli, 2 metri di elastico



Maschere da decorare

Queste maschere supportano la maggior parte dei collanti e costituiscono un'ottima base per moltissimi tipi di colore. I bambini potranno divertirsi a dipingere la propria maschera e decorarla con carta, cartoncini, glitter, capelli finti...



09843
set 12 maschere bianche
cm.14x20



09842
set 4 maschere
effetto velluto cm.15x21



09841
set 6 maschere
effetto velluto cm.12x17



68538
maschera donna cm.15,5x20,5



09844
set 6 maschere GOLD
cm.12x17



09845
set 4 maschere GOLD
cm.14x21



09913
maschera a specchio
CROMOMASK cm.16x22

68539

maschera uomo cm.15,5x23

Maschere veneziane

Maschere con elastico/cerchietto:

● **07321**
maschera "Colombina" oro chiaro - con elastico



07321



07322



07323

07322
maschera "Colombina" oro ricco - con elastico

07323
maschera "Pulcinella" con elastico

07324
maschera "Zanni" con cerchietto

07325
maschera "Capitano" con cerchietto



07324



07325

24 FARFALLE
CON ELASTICO
(in plastica)

74020x24

colore nero

74015x24

colori assortiti



Colori per viso

Set di cosmetici, sicuri e atossici. Conformi alle normative CE sulla sicurezza, dermatologicamente testati.



09828

confezione trucchi teatrali
6 pasticche ø mm.30 colori classici
+ 2 pennelli



09829

confezione trucchi teatrali
6 pasticche ø mm.30 colori perla/metal
+ 2 pennelli per trucco



09827

confezione trucchi teatrali
6 pasticche ø mm.45 (gr.15 cad.)
colori assortiti + 2 pennelli per trucco,
1 spugna, 1 libretto idee illustrato



64001

fondotinta fluido ml.38 - nero

64002

fondotinta fluido ml.38 - bianco

64008

fondotinta fluido ml.38 - marrone



08045

blister 6 colori per viso - colori assortiti

09832

set trucchi teatrali 6 pastelli
lungh. mm.62 - colori assortiti

09833

set trucchi teatrali 12 pastelli
lungh. mm.62 - colori assortiti



Make up



64027
make up PIRATA



64025
make up CLOWN



64024
make up COMMANDO



64019
make up animaletti
soggetti assortiti



09831
confezione 4 pasticche ø mm.32
colori soft (bianco, rosa, argento,
nero) + 1 pennello + 1 spugna



10753 a 10756
bombola spray lacca colorata
per capelli ml.100
10753 - bianco **10754** - verde
10755 - rosso **10756** - blu

Spugnette per il trucco



09834
set 2 pennelli e 2 spugnette
per trucco



09835
set 6 mezze spugnette
per applicare il trucco teatrale



Carrelli/mobili dei travestimenti

Veri e propri guardaroba provvisti di ripiani, barra appendiabiti e grande specchio. Indicati per bambini da 4 a 6 anni per favorire i processi di imitazione, drammatizzazione, scoperta di sé tramite i travestimenti.

+4
ANNI



09617

carrello/mobile dei travestimenti (in legno)
cm.65x50x112 h con specchio sicurezza



09625

carrello/mobile dei travestimenti con anta separè
cm.115x50x112 h con specchio sicurezza

09626

carrello/mobile dei travestimenti (in legno)
cm.65x50x112 h con specchio sicurezza

Mobile Beauty Center

L'angolo del trucco e della bellezza per bambini dai 4 ai 6 anni. Resistentissima struttura composta da parete con specchio di sicurezza, tavolo e comoda panca.

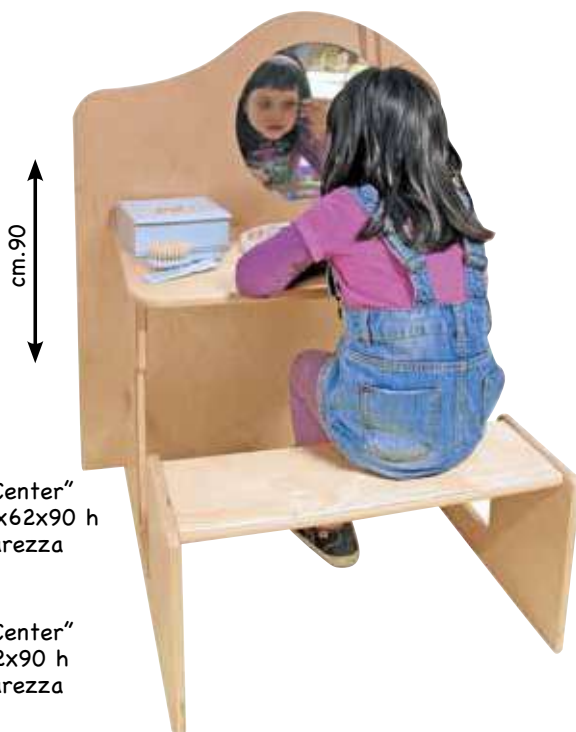

cm.90

+4
ANNI

09624

mobile "Beauty Center"
in betulla cm.75x62x90 h
con specchio sicurezza

09620

mobile "Beauty Center"
in MDF cm.75x62x90 h
con specchio sicurezza

Set Beauty

Il set è composto da 11 pezzi: flacone di crema, specchio, pettine, smalto per unghie, rossetto, profumo, asciugacapelli, cipria, fascia e 2 laccetti per capelli, il tutto contenuto in un bellissimo beauty case con maniglia!

BJ490

set BEAUTY (in legno)
valigetta cm.29x21x9,2

+3
ANNI



516 Gioco simbolico e di immaginazione

Creare burattini

05497

la confezione contiene: 6 sagome base in panno lenci, istruzioni per l'uso, fogli di panno lenci colorati per ricavare i particolari, occhietti mobili, cartamodelli per realizzare con facilità le sagome di alcuni animali



Burattini da dita



BJ704

burattini da dita I REALI
Totale 6 pezzi. Altezza burattini cm.12

+3
ANNI



BJ705

burattini da dita 3 STORIE
cappuccetto rosso, 3 porcellini, gatto con gli stivali
Totale 6 pezzi. Altezza burattini cm.12

Teatro dei burattini da dita

SCENARI



51786

teatro dei burattini (in legno) cm.28x20x25
con scenari interscambiabili

+3
ANNI



Teatrino

● **06815**

teatrino (in legno)
cm.40x96 h

Tradizionale teatrino, dalla struttura in robustissimo legno. Ideale per inscenare fiabe e storie con burattini e marionette.

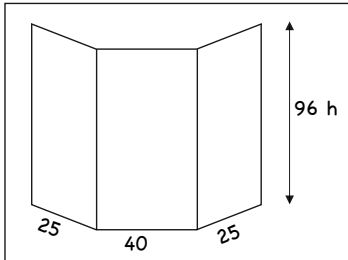

BJ339

teatro in legno dei
burattini cm.65x65



10400

mobile in legno cm.87x168 h
completo di sipario e tende

Mercatino/teatrino



MERCATINO



TEATRINO



10402

mobile in legno cm.82x51x113,5 h
(include tettoia rossa per mercatino e tenda
e sipario per trasformarlo in teatrino)

518 Gioco simbolico e di immaginazione

Strumenti musicali

Flauto

Tradizionale strumento a fiato perfetto per uso pre-scolastico e scolastico. Prodotto in resistentissima plastica ABS. Smontabile in 3 parti, facilmente lavabile.

875

flauto cm.33 modello "Prime Note" diteggiatura moderna (tedesca)

kazoo

Divertente strumento a fiato con suono variabile in tono e altezza.



11244

5 pezzi colori assortiti - lunghezza cm.12



Campanelle della melodia

8 campanelle con impugnatura colorata (ogni colore corrisponde a una nota, per facilitarne il riconoscimento) intonate sulla scala di DO. Particolarmente indicate per affinare le abilità di riconoscimento uditivo e per l'educazione musicale. Utilizzabili anche da 8 differenti partecipanti.



08887

set 8 campanelle delle melodie
Scala DO-RE-MI-FA-SOL-LA-SI-DO



Strumenti musicali



06408

cembalo in fibra ø cm.15

06409

cembalo in fibra ø cm.21

08354

tamburello in legno
ø cm.15 + battente

06414

tamburello in legno
ø cm.21 + battente

06415

tamburello in legno
ø cm.25 + battente



08137

tamburo "mare" cm.25x3,5

Con movimenti oscillatori riproduce il suono del mare (non servono batterie)



08138

tamburello in legno
ø cm.15 con piattelli

06412

tamburello in legno
ø cm.21 con piattelli



11892

tamburo da marcia ø cm.20

08133

bongo in legno
cm.37x37x31



11891

coppia maracas (in legno)
cm.20x5,5

08134

coppia uova (in plastica)
cm.5,5 h



06396

coppia di nacchere (in plastica)
ø cm.6



06397

nacchera (in plastica)
ø cm.6x17,5

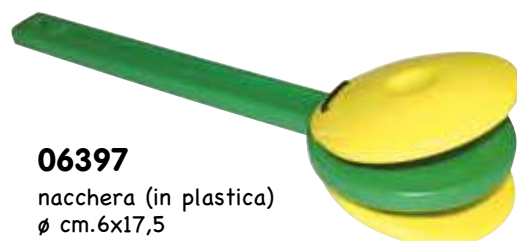

Strumenti musicali



06394

guiro (in legno) + battente
 ø cm.4x19,5



06392

coppia di clave (in legno)
 cm.2x18



06393

mini blocco tonale (in legno)
 + battente - ø cm.3,5x13



06395

blocco bitonale (in legno) + battente
 ø cm.4x19,5x23



06400

jingle stick (in legno) cm.15



06401

asta musicale
 cm.22x4x4



11885

impugnatura con campanelli
 cm.15x2x2



06403

impugnatura con campanelli
 ø cm.6x19,5



06402

maniglia con 5 campanelli cm.10



11888

cabasa (in legno) e metallo ø cm.8,5



11890

kokiriko a 15 elementi cm.25



08135

coppia bracciali con campanelli

08136

cintura con campanelli

Strumenti musicali



06406

coppia di piatti con impugnatura ø cm.15

06405

coppia piattelli a dita in acciaio ø cm.6,4

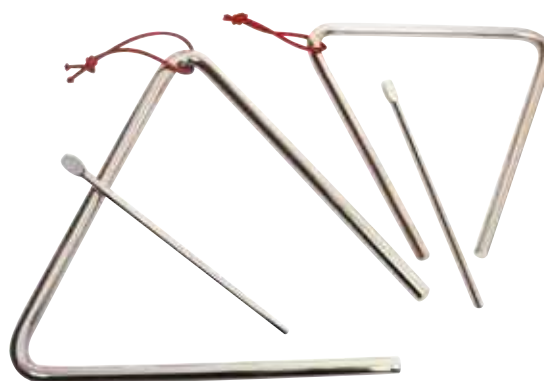

06410

triangolo (in acciaio cromato)
+ battente cm.15

06411

triangolo (in acciaio cromato)
+ battente cm.20



08355

set 5 strumenti musicali:
1 coppia maracas, 1 asta musicale,
1 triangolo in acciaio con battente,
1 metallofono, 1 cembalo



11893

set di classe strumenti musicali
da percussione
Il set contiene: 1 tamburello,
1 paio di maracas in legno,
2 uova musicali, 1 paio di nacchere,
2 piatti, 1 triangolo,
2 maniglie campanelli,
1 blocco bitonale, 2 aste musicali



08140

set strumenti musicali:
1 guiro in legno, 1 coppia di campanelle,
1 tamburello, 1 coppia di nacchere,
1 coppia di clave, 1 coppia di maracas
in legno, 1 maniglia con campanelli,
1 triangolo in acciaio con battente,

Metallofoni



11882

metallofono 13 toni (in metallo e legno) cm.34



06416

metallofono diatonico (in legno) con note colorate
Scala DO-FA con battente (in plastica e acciaio)
cm.33x11,5x4,5



11883

metallofono 25 toni in alluminio in box/valigetta
(in plastica) cm.55

12727

metallofono diatonico 11 note
cm.28x9x2



12728

metallofono cromatico 18 note
cm.27x17x2

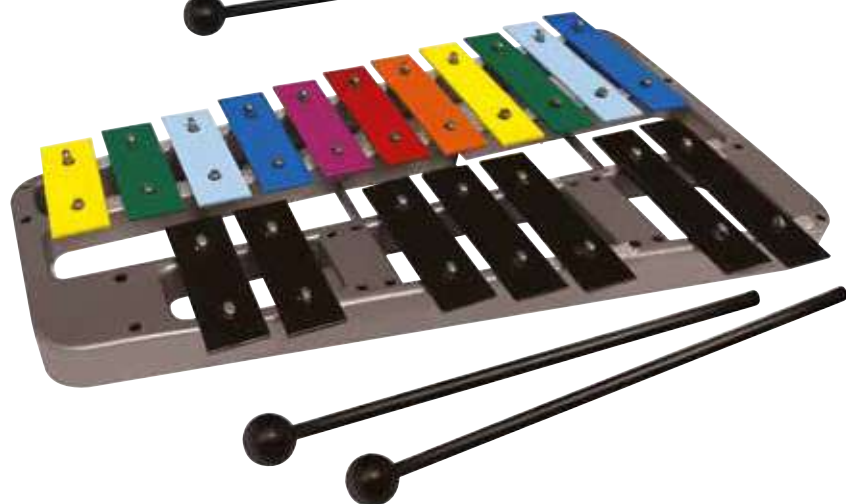

Colorati metallofoni in scala DO-C/FA-F. Particolarmente indicati per affinare le abilità di riconoscimento uditivo e per l'educazione musicale. Completi di spartiti semplificati per iniziare ad imparare a suonare.

Album da colorare con attività

Gli album sono ricchi di immagini appositamente studiate per le varie fasce di età e attività step by step che aiutano a rafforzare le abilità acquisite. Ogni album contiene anche coloratissimi stickers da aggiungere a ogni pagina! **Formato A4 (24 pagine)**



+3 ANNI

OTCB01

album ANIMALI



+3 ANNI

OTCB09

album DINOSAURI
(in inglese)



+3 ANNI

OTCB10

album FATTORIA
(in inglese)



+3 ANNI

OTCB11

album GIUNGLA
(in inglese)



+3 ANNI

OTCB12

album LO SPAZIO
(in inglese)



+4 ANNI

OTCB02

album ABC
(in inglese)



+4 ANNI

OTCB04

album PRIME PAROLE
(in inglese)



+4 ANNI

OTCB03

album NUMERI 1/10
(in inglese)



+4 ANNI

OTCB08

album NUMERI 1/20
(in inglese)



Libri per bambini

LEGENDA:

- > il mondo intorno al bambino
- > esperienze legate allo sviluppo del bambino
- > la vita quotidiana



+1 ANNI

08391

Guarda cosa so fare!



+1 ANNI

08392

Cosa trasporto?



+2 ANNI

08396

Anna si lava i denti



+2 ANNI

08403

Anna impara ad usare il water



+2 ANNI

08404

Mattia va all'asilo





La mia prima biblioteca

Una splendida piccola biblioteca illustrata ti aiuterà nei primi passi dell'apprendimento con l'aiuto di divertenti illustrazioni. Imparare leggendo e giocando non è stato mai così facile!

+2
ANNI

11444

Libretti "Leggo e imparo"



+2
ANNI

11446

Libretti in inglese "Read and Learn"

+2
ANNI

11445

Libretti "I miei piccoli cuccioli"



Tocca, scopri e impara

Un libro con coloratissime illustrazioni, tante diverse superfici da toccare e accarezzare, bellissime finestrelle da aprire per stimolare la curiosità dei bambini e scoprire il mondo divertendosi e giocando.

+3
MESI

11442

Libretti d'attività con inserti e finestrelle "I cuccioli" cm.18x18x18



Guide creative

Una serie di ricchissimi manuali a colori ideati per soddisfare i desideri degli appassionati di lavori creativi, delle insegnanti e di chi si cimenta per la prima volta con le attività manuali. I libretti che compongono questa collana sono una fonte inesauribile d'ispirazione per realizzare oggetti unici seguendo le tendenze più attuali.



- **06180**
"Creare libri-gioco per bambini" con cartamodelli



- DV7425**
"Creare con il découpage"



- 06171**
"Animali di polistirolo" con cartamodelli



- 06172**
"Biglietti per bambini" con cartamodelli



- **06174**
"Decorazioni per il Natale" con cartamodelli

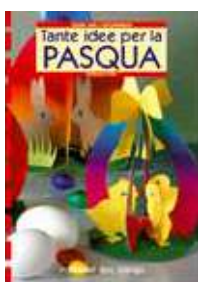

- **06175**
"Tante idee per la Pasqua" con cartamodelli



- **06217**
"Costruire maschere per bambini" con cartamodelli



- 06218**
"Calendari per bambini" con cartamodelli



- 06253**
"Decorare con le perline"



- 06254**
"Mandala in Window Color" con cartamodelli



- 06255**
"La tecnica dei tovaglioli di carta"



- 06258**
"Decorare l'Albero di Natale" con l'effetto vetro



- 06259**
"Decorazioni di Natale con perline e filo argentato"



- 06460**
"Creare burattini con i cucchiaini di legno" con cartamodelli



- 07104**
"Allegri progetti con lo scoubidou"



- 07373**
"Mosaico creativo" con cartamodelli

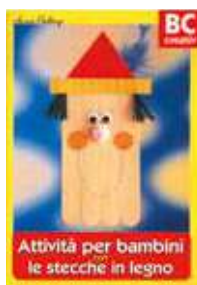

- **07374**
"Attività con le stecche in legno"



- 07654**
"Idee per piccoli regali" con cartamodelli



- **07657**
"Uova decorate con découpage e window color" con cartamodelli



- **07658**
"Pasqua creativa" con cartamodelli



07659
 "Calendari dell'avvento" con cartamodello

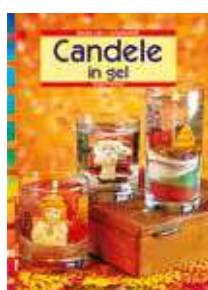

08019
 "Candele Gel" con cartamodelli



08020
 "Saponette personalizzate facili e veloci"

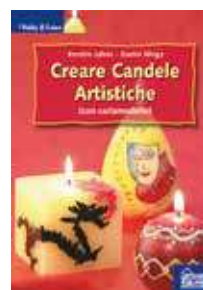

08021
 "Creare candele artistiche" con cartamodelli



08210
 "Realizzare presepi" con cartamodelli

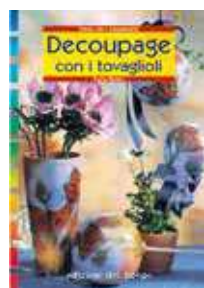

08211
 "Decorare con i tovaglioli"



08212
 "Tante idee per bomboniere e pacchetti regalo"



08213
 "Semplici idee in legno"



08209
 "Acquarelli e tempere"



08215
 "Colori acrilici"



08217
 "Tecniche del mosaico"



08218
 "Perline... non solo fiori"



08219
 "Fare stencil"



08221
 "Patchwork polistirolo"



08223
 "La rilegatura"

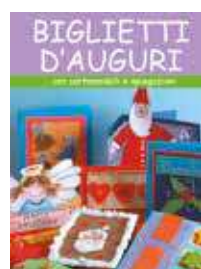

08224
 "Biglietti d'auguri" con cartamodelli



08228
 "La doratura"



08229
 "Dipingere i tessuti"



08231
 "Microsfere plus"



08232
 "Fantastico embossing"

Globi geografici

09351

globo ø cm.25 con luce

06989

globo ø cm.30 con luce

09352

globo ø cm.40 con luce



Sussidi a doppia rappresentazione cartografica. Tutti i globi sono dotati di luce ed evidenziano la parte fisica quando sono spenti e quella politica se accesi.



Carte geografiche

Carte geografiche da banco bifacciali: politica da un lato, fisica dall'altro.

Tutte le carte geografiche sono complete di asta e gancio per appenderle.



09343x10

10 cartine Italia
formato A4 (cm.21x29,7)



09344x10

10 cartine Europa
formato A4 (cm.21x29,7)



09350x10

10 cartine Mondo
formato A4 (cm.21x29,7)



09345x10

10 cartine Italia
formato A3 (cm.42x29,7)



09346x10

10 cartine Europa
formato A3 (cm.42x29,7)

Bifacciali

528 Gioco simbolico e di immaginazione

Carte geografiche bifacciali regionali - da parete

Carte geografiche delle regioni d'Italia. Bifacciali: politica da un lato, fisica dall'altro. Formato cm.100x140.
Tutte le carte geografiche sono complete di asta e gancio per appenderle.



da **09730** a **09743**

carte geografiche bifacciali regionali
cm.100x140



09730
Piemonte e Valle D'Aosta



09731
Lombardia



09732
Triveneto



09733
Liguria



09734
Emilia Romagna



09735
Toscana



09736
Marche e Umbria



09737
Lazio



09738
Campania



09739
Puglia e Basilicata



09740
Calabria



09741
Sicilia



09742
Sardegna



09743
Abruzzo e Molise

Carte geografiche bifacciali - da parete

Carte geografiche plastificate cm.100x140. Bifacciali: politica da un lato, fisica dall'altro.



06990
Italia



06991
Europa



06992
Asia



06993
Africa



06994
America Settentrionale e Centrale



06995
America Meridionale



06996
Oceania



06997
Planisfero



Movimento e psicomotricità

Il movimento è in assoluto il primo mezzo attraverso il quale i bambini iniziano a imparare e a sperimentare la realtà che li circonda. Muovendosi il bambino prova sensazioni ed emozioni, fa esperienze, impara a conoscere i propri limiti e a dosare la propria energia. E i bambini in età prescolare e scolare - si sa - sono una fonte inesauribile di energia! Cosa c'è di meglio che incanalare questa energia in attività divertenti che aiutano a sviluppare la motricità fine e globale? In questa sezione troverete svariate proposte per organizzare attività motorie e psicomotorie adatte alle particolari esigenze e all'età dei bambini.

532 Nuvola

553 Materassi e tappeti

567 Attrezzi ginnici e psicomotricità

617 Dondoli, carriole e tricicli

NUVOLA

Questa linea ha l'obiettivo di offrire una serie di articoli indicati per varie ambientazioni. Partendo da una visione montessoriana e affiancandola alle diverse teorie pedagogiche vengono creati prodotti in grado di arricchire dal punto di vista professionale ed estetico gli ambienti e gli spazi educativi.

PROGETTAZIONE

Grazie alla collaborazione di professionisti ed esperti nei vari settori con la linea di arredi morbidi **nuvola** siamo in grado di offrire un servizio completo di consulenza tecnica, fornendo elaborazioni progettuali personalizzate.

QUALITÀ

La qualità di produzione, con l'utilizzo di materiali e tecnologie sempre più innovativi e attenti ai valori della sostenibilità ambientale, è assicurata da un attento controllo e dal rispetto delle normative CE.

I MATERIALI:

• Gli interni

La maggiorparte degli articoli (percorsi, scivoli, tunnel, dondoli, puzzles) è prodotta in poliuretano espanso di densità Kg.28 PS al metro cubo. Gli articoli soggetti ad omologazione in classe 1-IM (sedute e materassi) sono prodotti in poliuretano espanso.

• I rivestimenti

Tutti gli articoli sono dotati di fodere intercambiabili e pertanto è possibile provvedere alla sostituzione delle stesse in caso di rottura o logoramento. Gli articoli imbottiti con polistirolo granulare espanso ed in particolare cuscini, cuscinoni e pouf sono dotati di doppia fodera e sono rivestiti esternamente con tessuto trevira, molto resistente, atossico, lavabile con acqua a 40° C.

GLI ACCESSORI

Le chiusure della linea MATERNA sono assicurate da cerniere robuste dotate di cursori arrotondati e protetti, mentre nella linea NIDO le chiusure sono assicurate mediante il velcro. Questi articoli sono dotati anche di fondo antiscivolo.

OMOLOGAZIONE E CONFORMITÀ

Gli articoli sono soggetti a omologazione e rispondono alle normative CE.



NUVOLA è la linea MADE IN ITALY in grado di offrirvi un'ampia gamma di morbidi prodotti in forme e colori differenti studiati per garantire ai bambini grande comfort e massima sicurezza.

La linea di arredi morbidi propone un luogo ricco di armonia che possa aiutare i bambini nei loro processi relazionali e di apprendimento.

...per i più piccoli:



...per i più grandi:



3-36
mesi
NIDO

ELEMENTI BASE

CM.6/24 H

RIVESTIMENTO

ECOPELLE

I colori del rivestimento sono puramente indicativi



10006



10004



10095
10204



10010



10150



10026



10007



10005



10022



10024



10009

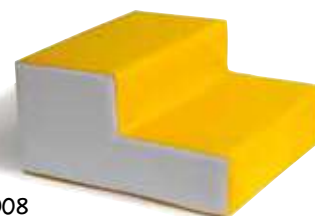

10008



10023



10003



10021

10006

materassino rettangolare cm.48x72x6 h

10010

materassino quadrato cm.48x48x6 h

10007

parallelepipedo cm.24x48x12 h

10024

angolo cm.70x70x10 h

10023

parallelepipedo cm.48x48x12 h

10004

angolo cm.48x48x6 h

10150

parallelepipedo cm.48x24x24 h

10005

angolo cm.48x48x24 h

10009

parallelepipedo cm.48x48x24 h

10003

scivolo cm.48x48x24/6 h

10095

cubo cm.24x24x24 h

10204

set 4 cubi cm.24x24x24 h

10026

bascula cm.48x72x24/6 h

10022

grandi onde cm.48x72x24/12 h

10008

scaletta cm.48x48x24/12 h

10021

piccole onde cm.48x72x24/12 h

3-36
mesi
NIDO

COMPOSIZIONI CON ELEMENTI BASE

CM.6/24 H

RIVESTIMENTO

ECOPELLE

I colori del rivestimento sono puramente indicativi



10121

composizione CUCCIOLO
(1 pezzo 10008, 1 pezzo 10009,
1 pezzo 10022, 1 pezzo 10004,
1 pezzo 10006, 1 pezzo 10010)



10031

composizione DOTTO
(1 pezzo 10003, 1 pezzo 10008)



10032

composizione EOLO
(1 pezzo 10003, 1 pezzo 10008, 1 pezzo 10009)

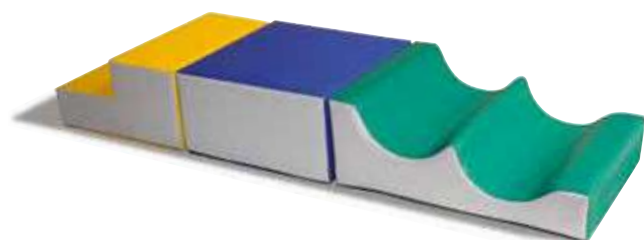

10033

composizione MAMMOLO
(1 pezzo 10008, 1 pezzo 10009, 1 pezzo 10021)

10034

composizione PISOLO
(1 pezzo 10008, 1 pezzo 10009, 1 pezzo 10022)

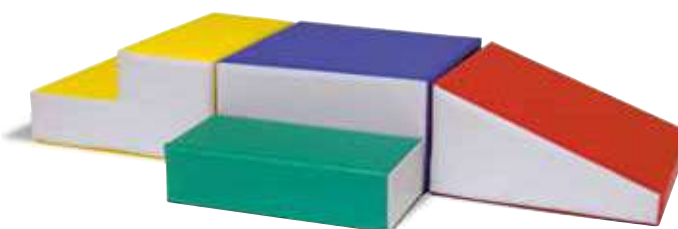
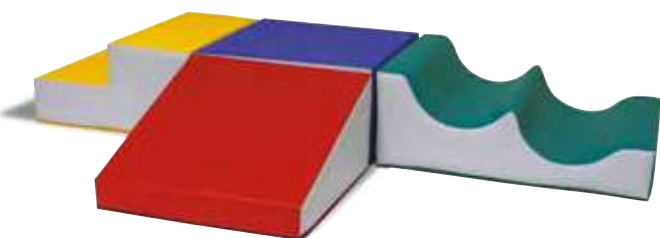

10050

composizione BRONTOLO
(1 pezzo 10003, 1 pezzo 10008, 1 pezzo 10009, 1 pezzo 10021)

10051

composizione GONGOLO
(1 pezzo 10003, 1 pezzo 10008, 1 pezzo 10009, 1 pezzo 10007)

534 Movimento e psicomotricità



10177

composizione MICKEY MOUSE
 (1 pezzo 10003, 1 pezzo 10008, 1 pezzo 10009,
 1 pezzo 10021, 1 pezzo 10022)



10036

composizione MINNIE
 (1 pezzo 10003, 1 pezzo 10008, 1 pezzo 10009,
 1 pezzo 10021, 1 pezzo 10022, 4 pezzi 10004)

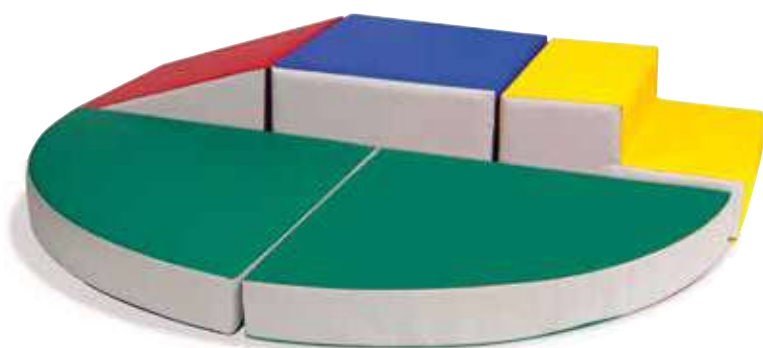

10035

composizione PLUTO
 (1 pezzo 10003, 1 pezzo 10008, 1 pezzo 10009, 2 pezzi 10024)



10037

arco cm.48x48x58 h

10030

tunnel cm.72x48x72 h



10120

composizione LINUS
 (1 pezzo 10009, 1 pezzo 10008, 1 pezzo 10003, 1 pezzo 10037)

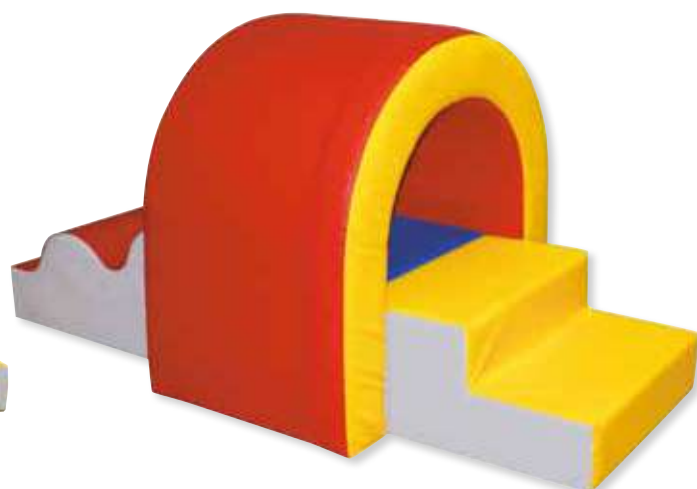

10179

composizione SNOOPY
 (1 pezzo 10030, 1 pezzo 10022, 1 pezzo 10008,
 1 pezzo 10150)

3-36
mesi

NIDO

RIVESTIMENTO
ECOPELLE

10173

percorso a rulli
dimensione totale: cm.165x80x40 h
composto da: 1 elemento base
cm.165x80x10, 2 cilindri cm.80x15 ϕ ,
2 cilindri cm.80x20 ϕ , 2 cilindri
cm.80x25 ϕ , 1 cilindro cm.80x30 ϕ

I colori del rivestimento sono puramente indicativi



Puzzle



10189

elemento a L verde acido cm.48x48x24 h



● **10082**

puzzle rosso cm.50x50/70x12 h

● **10083**

puzzle arancio cm.50x50/70x12 h

● **10084**

puzzle verde acido cm.50x50/70x12 h

● **10085**

puzzle azzurro cm.50x50/70x12 h



Multifunzionali!

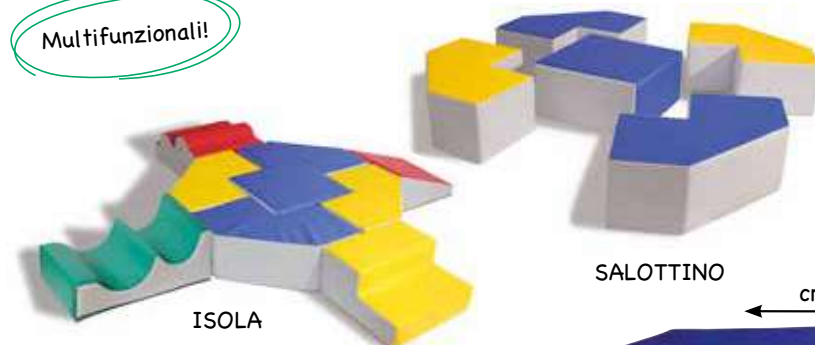

ISOLA

SALOTTINO

cm 48



Spicchi esagonali

● **10020**

spicchio esagonale blu cm.48x48x24 h



536 Movimento e psicomotricità

3-36
mesi
NIDO

3-5
anni
MATERNA

ELEMENTI BASE
CM.30 H

RIVESTIMENTO
ECOPELLE

I colori del rivestimento sono puramente indicativi

● RESISTENTI!

Prodotti con poliuretano espanso densità kg.28 PS per metro cubo e rivestiti con tessuto plastico.

● IGIENICI

● SFODERABILI

● ANTIBATTERICI

10109

set 10 solidi geometrici IN ECOPELLE
(4 cubi, 1 parallelepipedo,
2 cilindri, 1 semicilindro, 2 prisma)

Gli elementi contenuti nella foto sono puramente indicativi



05280
10100



11355



05279



11354

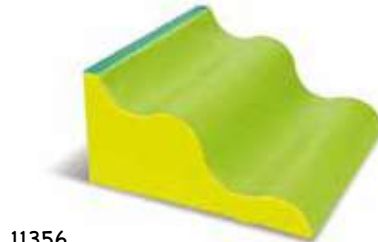

11356



05281



10097



05278

05277



05265



05274



05275



10098

05280

cubo cm.30x30x30

10100

set 4 cubi cm.30x30x30

11354

scala cm.60x60x15/30 h

10097

parallelepipedo cm.15x90x30 h

05274

cilindro cm.30x30 h

11355

mezzo cubo cm.60x60x30 h

11356

onda cm.60x60x10/30 h

05277

semicilindro cm.30x30 h

05278

semicilindro cm.30x60 h

05275

cilindro cm.30x60 h

05279

prisma cm.30x30x30 h

05281

parallelepipedo cm.30x60x30 h

05265

pedana cm.60x60x30 h

10098

cilindro cm.30x90 h

3-36
mesi
NIDO

3-5
anni
MATERNA

ELEMENTI BASE

RIVESTIMENTO

CM.30 H

TESSUTO IN MICROFIBRA

I colori del rivestimento sono puramente indicativi



10108

set 9 solidi geometrici in tessuto
(4 cubi, 1 parallelepipedo, 2 cilindri, 2 prisma)

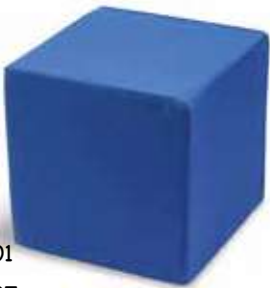

10101
10107

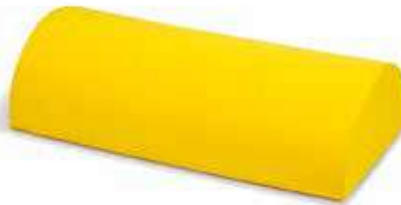

10105



10106



10102



10103



10104

10101

cuco cm.30x30x30x30

10107

set 4 cubi cm.30x30x30

10102

parallelepipedo cm.30x90x15 h

10105

semicilindro cm.30x60 h

10103

parallelepipedo cm.30x60x30 h

10106

prisma cm.30x30x30

10104

cilindro cm.30x60 h

538 Movimento e psicomotricità

3-36
mesi
NIDO

3-5
anni
MATERNA

ELEMENTI BASE
CM.45 H

RIVESTIMENTO
ECOPELLE

I colori del rivestimento sono puramente indicativi

Strisce di velcro di cm.5 di larghezza che garantiscono un facile montaggio ed una particolare stabilità agli elementi.

10096

primi percorsi cm.260x60x45 h
composto da:
1 scala, 1 tunnel, 1 onda,
1 cilindro ø cm.35

4 solidi ecopelle

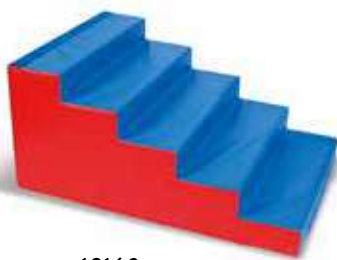

10162

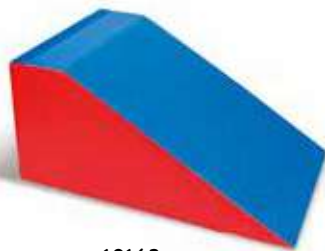

10163

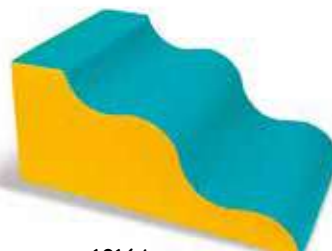

10164



10165

10162

scala cm.100x60x45 h

10163

scivolo cm.100x60x45 h

10164

onda cm.100x60x45 h

10165

tunnel cm.60x60x45 h
con cilindro ø cm.35

ESEMPI



A - 10164 + 10162



B - 10164 + 10163



C - 10163 + 10162

3-36
mesi
NIDO

3-5
anni
MATERNA

ELEMENTI BASE
CM.60 H

RIVESTIMENTO
ECOPELLE

I colori del rivestimento sono puramente indicativi

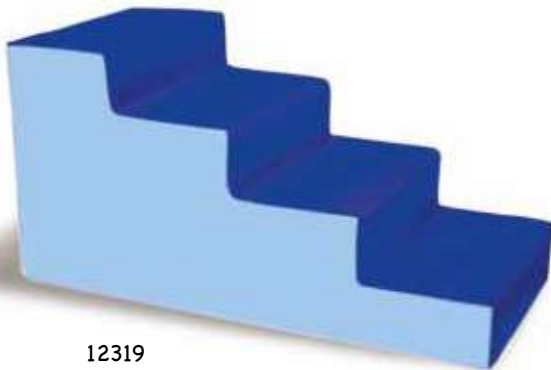

12319

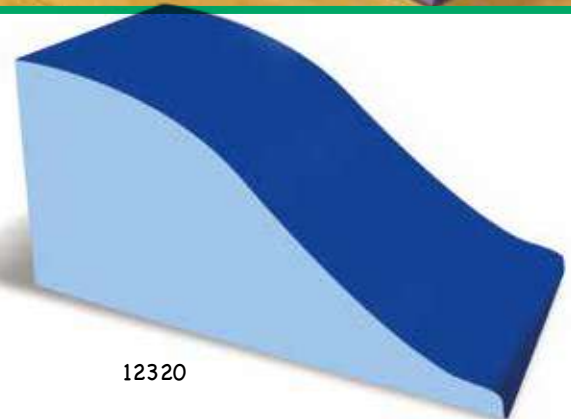

12320

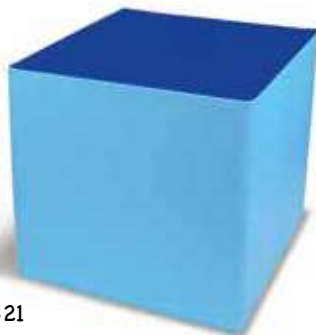

12321

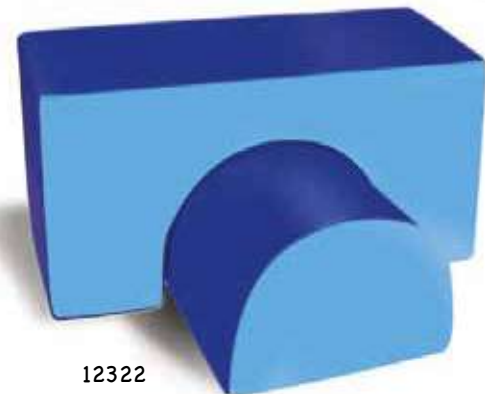

12322

12319

maxi scala cm.120x60x60 h

12321

maxi cubo cm.60x60x60 h

12320

maxi onda cm.120x60x60 h

12322

maxi ponte con semicilindro cm.120x60x60 h

540 Movimento e psicomotricità

3-36
mesi
NIDO

3-5
anni
MATERNA

ELEMENTI BASE
CM.60 H

RIVESTIMENTO
ECOPELLE

I colori del rivestimento sono puramente indicativi



05269

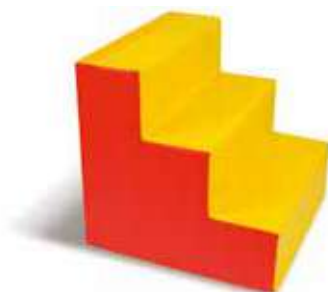

05261



05266



10166



05262



05267



10167



05265



05282



05263



05260



05276

05269

supporto H cm.30x60x48 h

10166

cubo cm.60x60x60

10167

cilindro \varnothing cm.60x60 h

05263

scivolo cm.60x120x60 h

05261

scala cm.60x60x60 h

05262

doppia onda cm.120x60x60 h

05265

pedana cm.60x60x30 h

05260

ponte cm.60x80x60 h

05266

ruota \varnothing esterno cm.120x30 h

05267

mezza ruota cm.60x120x30 h

05282

parallelepipedo cm.30x120x30 h

05276

cilindro \varnothing cm.30x120 h

3-5
anni

MATERNA

COMPOSIZIONI CON ELEMENTI BASE

CM.60 H

RIVESTIMENTO

ECOPELLE

I colori del rivestimento sono puramente indicativi



10171

composizione PIMPA
(2 pezzi 05269, 1 pezzo 05282, 1 pezzo 05259)

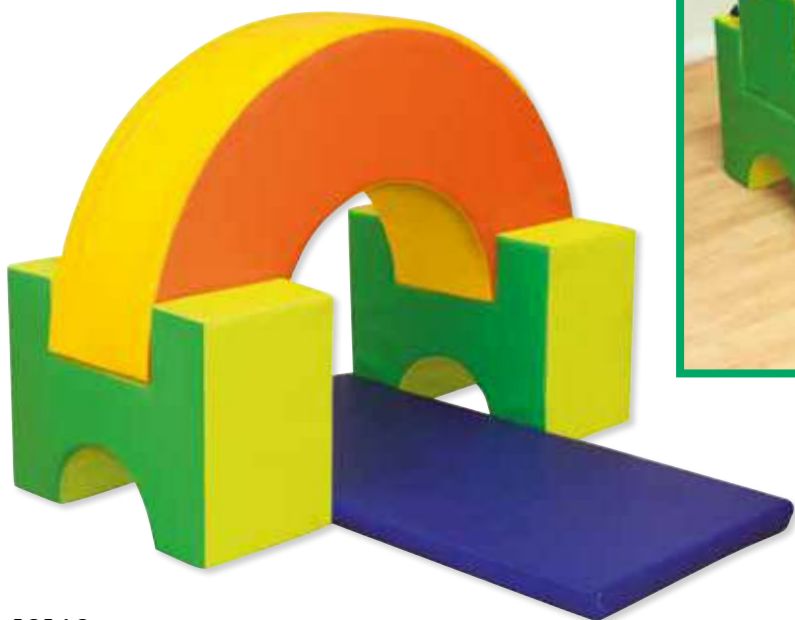

10168

composizione TOM
(2 pezzi 05269, 1 pezzo 05267, 1 pezzo 05259)



10170

composizione BAMBY
(2 pezzi 05269, 1 pezzo 05276, 1 pezzo 05259)



10169

composizione JERRY
(2 pezzi 05269, 1 pezzo 05266, 1 pezzo 05259)

542 Movimento e psicomotricità

3-36
mesi
NIDO

3-5
anni
MATERNA

RIVESTIMENTO ECOPELLE



SEDUTA CM.17

10152

poltroncina cm.40x30x38 h

10153

divanetto cm.40x60x38 h

SEDUTA CM.25

05271

poltroncina cm.50x40x50 h

05272

divanetto cm.50x80x50 h

10856

pouf quadrato cm.50x50x25 h

10857

pouf tondo ø cm.48x25 h

SEDUTA CM.32

10858

poltroncina cm.60x50x60 h

10859

divanetto cm.60x100x60 h



Sedute per bambini

10016

ciambella cm.46x60x15 h

Sedute per adulti

Tutti gli elementi necessari per arredare in modo confortevole la zona dell'Accoglienza, dove i genitori e gli educatori si incontrano insieme ai bambini, si salutano, sostano in attesa dei propri figli... Divano, poltrona e pouf sono realizzati in morbida gommaspugna, con igienico rivestimento lavabile, traspirante e antibatterico.



10265

morbido divano profondità
cm.70x120x73 h

10266

morbido pouf cm.50x50x40 h

10264

morbida poltrona profondità
cm.70x60x73 h

Pluritunnel

Percorso di tunnel decrescenti che aiuta il bambino a raggiungere un buon controllo motorio che gli permette di mettersi in relazione con lo spazio rafforzando la fiducia nelle proprie capacità. I singoli elementi tunnel, sovrapponibili, consentono di sviluppare una struttura lunga fino a 3 mt. Rivestimento ecopelle.



10175

pluritunnel 2 composto da: 1 tunnel piccolo cm.100x60x55 h
+ 1 tunnel medio cm 100x80x65 h
(elemento interno compreso nella struttura)



10176

pluritunnel 3 composto da:
1 piccolo tunnel cm.100x60x55 h
+ 1 medio cm.100x80x65 h
+ 1 grande tunnel cm.100x100x75 h
(elemento interno compreso nella struttura)

La scatola dei sogni

Può essere utilizzata per giocare, nascondersi o può essere trasformata in un tappeto per fare ginnastica. Composta da 6 pannelli in morbida gommapiuma ancorabili tra loro mediante strisce di velcro. Rivestimento ecopelle.

10172

scatola dei sogni (6 elementi)
dimensioni struttura montata: cm.120x100x100 h
dimensioni struttura a pavimento: cm.280x200x10 h



Morbide sedute



10018

divano/materasso multiuso
divano: cm.55x120x52 h
materasso: cm.150x120x13 h

4 elementi uniti tra loro da strisce di velcro consentono la facile trasformazione da divano a pratico materasso multiuso!



10078

divano/materasso angolare
cm.140x140x10 h

3 elementi: 2 braccioli e un grande materasso quadrato bicolore che ripiegato si trasforma in un pratico divano angolare!



**RIVESTIMENTO
ECOPELLE**

Morbide scoperte

Una delle fasi fondamentali dello sviluppo evolutivo è costituita dal riconoscimento di sé, della propria immagine e dall'identificazione di sé stessi. Grazie a questi specchi il bambino potrà familiarizzare con la propria immagine. Tutti gli specchi sono realizzati in plastica antiurto molto resistente; riflettono una discreta qualità di immagine.

Per la pulizia degli specchi si consiglia di utilizzare un panno morbido con acqua.



● **10122**

angolo delle meraviglie composto da 2 specchi plex (cm.120x60) e 1 tappeto (lato cm 120x2 h)

pag.683
specchi
multieffetto

Morbidi cavalcabili

RIVESTIMENTO
FINITA PELLE



● **10154**
pesce cm.83x23x40 h
seduta cm.23 h
rivestimento in ecopelle



● **07488**
giraffa cm.61x20x70 h
rivestimento in ecopelle



● **09990**
mucca cm.82x25x40 h
rivestimento in tessuto plastificato
fintapelle (con effetto ottico
pelle mucca pezzata) Ignifuga



● **10157**
vagone rosso cm.80x20x40 h
seduta cm.23 h

Materasso mosaico

Igienici e facilmente lavabili, sono provvisti di fondo antiscivolo e strisce in velcro per il fissaggio.

10181 - tappeto azzurro cm.48x48x6 h

10182 - tappeto verde cm.48x96x6 h

10183 - tappeto arancione cm.96x96x6 h

10184 - tappeto blu cm.96x144x6 h

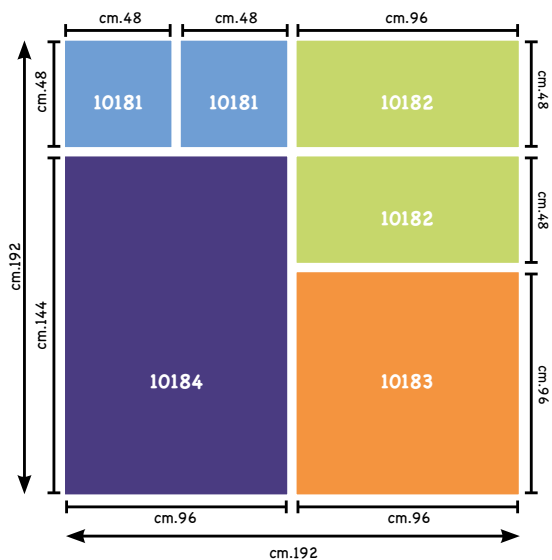

RIVESTIMENTO
ECOPELLE

10185
materasso mosaico 4 pezzi
(2 pezzi 10184, 2 pezzi 10182)
dimensione totale cm.192x192x6 h

10186
materasso mosaico 6 pezzi
(1 pezzo 10184, 1 pezzo 10183, 2 pezzi 10181,
2 pezzi 10182) dimensione totale cm.192x192x6 h

Piscine



Piscine di palline o cuscini che permetteranno ai bambini di prendere coscienza del proprio corpo, di tuffarsi, immergersi e sprofondare... in totale sicurezza!

10017

piscina con materassino di fondo
cm.150x150x36 h

09969

piscina con materassino di fondo
cm.205x205x36 h

05254

piscina con materassino di fondo
cm.200x200x50 h



10028

piscina cm.150x150x36 h
con materassino di fondo
+ 8 cuscini colorati

05253

4 cuscini cm.50
(tondi + quadrati)



11232

conf. 100 palline \varnothing cm.8,5
(0,044 m³: cm.25x39x45)

11231

conf. 500 palline \varnothing cm.6,5
(0,15 m³: cm.50x50x60)

10029

piscina cm.150x150x36 h
con materassino di fondo
+ 1000 palline

Morbidi cuscini

Cuscini soffici e morbidi al tatto dai colori vivaci. Imbottiti con polistirolo granulare espanso. Le fodere sono realizzate con tessuto di trevira, molto resistente.

- RIVESTIMENTO IGNIFUGO CLASSE 1
- ATOSSICO
- LAVABILE A 40°



SUPER
LAVABILE!

12314

pouf morbido imbottito con granulato
cm.100x49



10074

4 cuscini quadrati cm.90x90



05253

4 cuscini cm.50x50
(tondi + quadrati)

10073

8 cuscini cm.50x50
(quadrati)



09963

cuscione MULTICOLOR
quadrato cm.110x110



10076

grande pouf MULTICOLOR
quadrato cm.180x180



10099

maxi pouf MULTICOLOR
tondo a spicchi ø cm.130



10075

cuscione rettangolare
cm.200x100

Materassini

Materassini realizzati con interni in poliuretano espanso vinilico di alta densità e rivestiti in materiale plastico lavabile.

- ATOSSICO
- LAVABILE A 40°

RIVESTIMENTO

ECOPELLE



10254

materassino bicolore cm.130x65x4 h



10064

materassino con animali cm.150x150x2 h



10195

materassino con papera cm.150x150x2 h



10196

materassino con trenino cm.150x150x2 h

Materassi

RIVESTIMENTO
ECOPELLE

- **IMBOTTITURA:** 100% spugna in poliuretano
- **DENSITÀ IMBOTTITURA:** 28 kg
- **RIVESTIMENTO:** ecopelle
- **LAVABILI**

10019

materasso gigante con maniglie
cm.200x200x6 h

10087

materasso gigante con maniglie
cm.200x300x6 h



09980

materassino sfoderabile
cm.120x60x8 (fantasie assortite)

12239

materassino cm.100x50x8 (fantasie assortite)

10086 - materasso cm.140x140x5 h

05259 - materasso cm.70x180x4 h

05257 - materasso cm.100x200x5 h

10056

materasso pieghevole
cm.121x182x5 h



- **IMBOTTITURA:** 100% spugna in poliuretano
- **DENSITÀ IMBOTTITURA:** 18 Kg
- **RIVESTIMENTO:** tessuto plastico in lattice, 100% VINILE
- **RETRO:** tessuto Spandex, 65% polyester 35% rayon



10135

5 materassini
cm.120x55x5 h
colori assortiti



- **IMBOTTITURA:** 100% spugna in poliuretano
- **DENSITÀ IMBOTTITURA:** 18 Kg
- **RIVESTIMENTO:** tessuto plastico, 100% VINILE
- **RETRO:** tessuto plastico, 100% VINILE



12431

materassino pieghevole cm.122x60x2,5 h

● **09727**

materassino pieghevole cm.122x60x5 h

550 Movimento e psicomotricità

Materassi ginnici

DENSITÀ 18 KG/M³

10088

materasso cm.200x100x10 h
fondo liscio

10089

materasso cm.200x100x10 h
fondo antiscivolo

10058

materasso cm.200x100x20 h
fondo liscio

10090

materasso cm.200x100x20 h
fondo antiscivolo

10059

materasso cm.200x100x30 h
fondo liscio

10091

materasso cm.200x100x30 h
fondo antiscivolo

10060

materasso cm.200x100x40 h
fondo liscio

10092

materasso cm.200x100x40 h
fondo antiscivolo

10061

materasso cm.200x100x50 h
fondo liscio

10093

materasso cm.200x100x50 h
fondo antiscivolo

Realizzati in poliuretano espanso completamente antipolvere. Tutti i materassi sono dotati di fodere con chiusura a lampo e pertanto è possibile sfoderare e sostituire, nel tempo, ogni rivestimento. Le cerniere utilizzate sono robuste e dotate di cursori arrotondati. Tutti i materassi sono dotati di doppia cucitura e sono disponibili in due versioni: senza antisdrucciolo o con antisdrucciolo, quest'ultimo particolarmente resistente che conferisce al materasso una grande aderenza al suolo.

I materassi con spessore pari o superiore a cm.20 h sono dotati di maniglie.

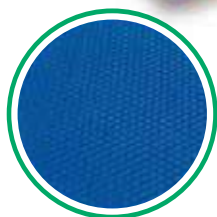
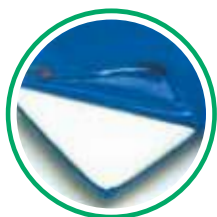
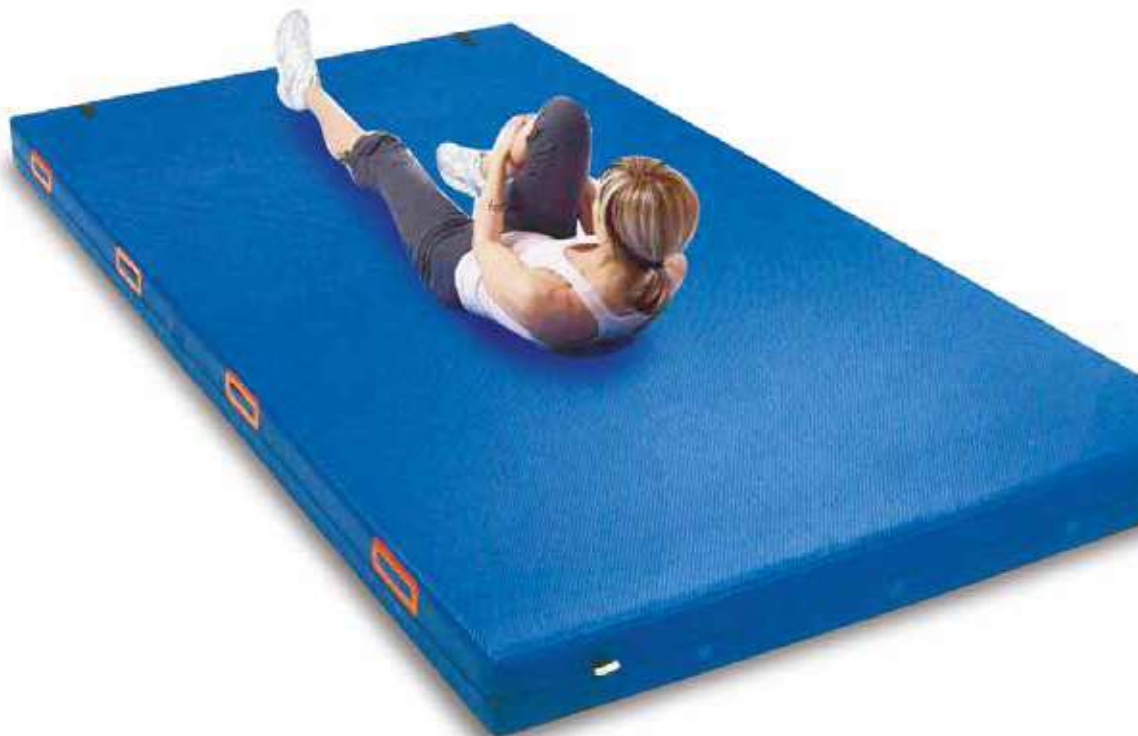

Carrello per materassi



10231

carrello porta materassi ginnici
cm.100x200



Materasso pieghevole

- IMBOTTITURA: 100% spugna in poliuretano
- RIVESTIMENTO: tessuto in microfibra
- 100% POLIESTERE
- SFODERABILE E LAVABILE A 30°C
- TRASPIRANTE E IMPERMEABILE

RIVESTIMENTO

POLIESTERE



10225

materassino con velcro cm.120x60x5 - rosso

10226

materassino con velcro cm.120x60x5 - blu

10227

materassino con velcro cm.120x60x5 - arancio

10228

3 materassini in poliестere con velcro sui lati cm.120x60x5 - colori assortiti



Lettino "Futon"

11327

cm.120x70 (cm.50 interno) x5 h
(cm.15 altezza sponda) colore blu
Morbido, leggero, impilabile.



● **10229**

mobile per materassi
cm.112x66x160 h

552 Movimento e psicomotricità

Materasso multifunzionale

pag.558
colla per moquette
e nastro biadesivo

Materasso multifunzionale da posizionare sul pavimento delle palestre per sport da combattimento e ginnastica oppure come protezione murale. Realizzato in polietilene reticolato ad alta densità. Lavabile.

- mm.20 in polietilene reticolato
- Densità 30
- Rivestimento in fiberpel

**BICOLORE (VERDE/ROSA)
RIVESTIMENTO IN FIBERPEL**

10454

materasso cm.101x101x2,2 h

10453

materasso cm.102x202x2,2 h

**COLOR ANTRACITE
(NON RIVESTITO)**

10851

materasso cm.101x101x2 h

10850

materasso cm.102x202x2 h



ALTRI UTILIZZI SUGGERITI:

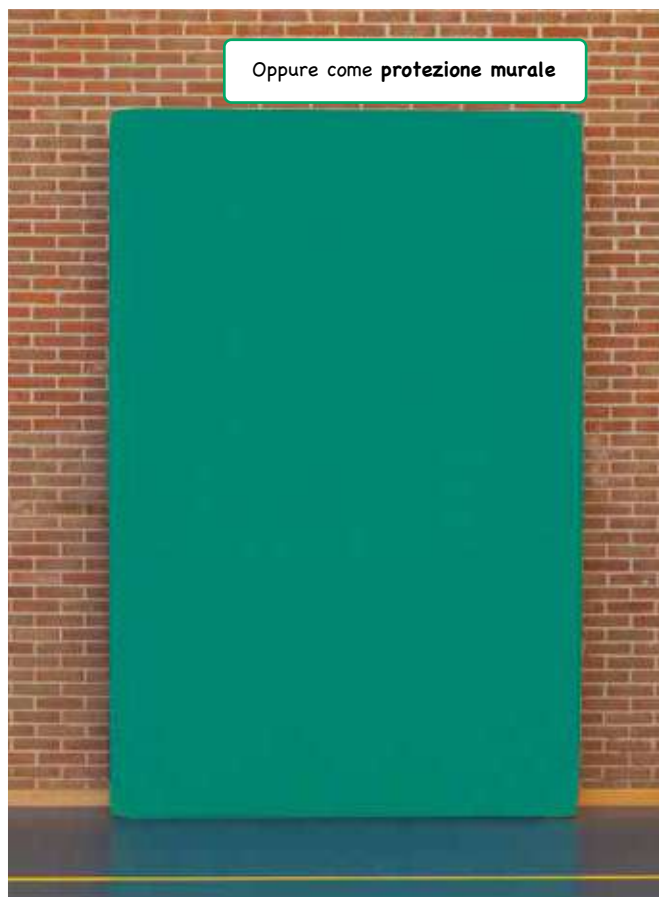

Mattonella Tatami

Ampi pannelli da posizionare sul pavimento delle palestre. Grazie alla loro considerevole dimensione consentono di realizzare una superficie omogenea e senza tante giunture, ideale per svolgere in tutta sicurezza attività sportive, arti marziali ecc. La superficie ripara dal freddo e dalla polvere e attutisce eventuali cadute.

- Realizzata in polietilene espanso reticolato
- Mattonella a incastro mt.1x1x2,2 cm spessore
- Anti funghi, antibatterico, anallergico
- Antiscivolo grazie alla goffratura in paglia di riso
- Reversibile, bicolore
- Lavabile, non assorbe acqua

10253

mattonella TATAMI metri 1x1
spessore cm.2,2
colore: rosso/blu



Tappeto Tatami in EVA

08946

tappeto TATAMI mq.6
spessore mm.25 - colore: rosso/blu
(composto da 6 tappeti a incastro cm.100x100 con bordi)

08947

tappeto TATAMI mq.6
spessore mm.25 - colore: verde/giallo
(composto da 6 tappeti a incastro cm.100x100 con bordi)



Tappeto multifunzionale

Tappeto multifunzionale da posizionare sul pavimento delle palestre per sport da combattimento e ginnastica oppure come protezione murale. Realizzato in polietilene reticolato rivestito in fiberpel ad alta densità. Lavabile.

- mm.20 in polietilene reticolato + mm.30 poliuretano
- Spessore mm.5
- Densità 30 kg/m³
- Rivestimento in fiberpel
- Sfoderabile e lavabile

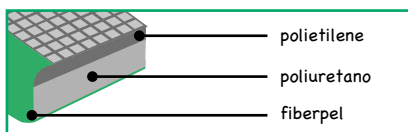

ALTA
DENSITÀ
30 KG/M³

10260

tappeto multifunzionale cm.100x100x5 h

10261

tappeto multifunzionale cm.100x200x5 h



554 Movimento e psicomotricità

Copricolonna

Per le colonne intere (4 lati o circolari) la protezione avvolge completamente la struttura e viene chiusa mediante fasce di velcro applicate, in altezza, alle due estremità. Per le colonne a muro (2/3 lati) la protezione viene ancorata a parete mediante velcro, con maschio applicato su protezione e con femmina fornito a parte, da fissare a muro.

MISURE: in fase di ordinazione è necessario fornire: l'altezza desiderata, la dimensione dei singoli lati o la circonferenza (per le colonne circolari).



10199

copricolonna 1 MQ spessore cm.6 - colore blu



Protezione murale

Protezione murale con fascia e asole nella parte superiore da appendere a muro con appositi ganci.

- **IMBOTTITURA:** 100% in poliuretano, K466
- **DENSITÀ IMBOTTITURA:** 18 Kg
- **RIVESTIMENTO:** tessuto plastico, 100% VINILE
- **RETRO:** tessuto plastico, 100% VINILE
- **DIMENSIONI:** cm. 122x56x5
- **PESO:** 1,2 Kg



10055

protezione murale tappeto bicolore con fori cm.120x56x5 h



Morbide pareti

Pareti morbide in poliuretano espanso. Ogni parete è completa di bastone in legno e ferramenta per il fissaggio al muro.



11879

parete morbida bicolore azzurro/blu cm.70x140

11880

parete morbida bicolore azzurro/blu cm.140x140

Stuoie alta qualità

Realizzate in polietilene reticolato a cellule chiuse, sono adatte per il tempo libero, per il campeggio, la spiaggia o per il fai da te.

10251

stuoia cm.180x50x0,7 h - blu

ALTA
DENSITÀ



10252

5 stuoie cm.180x50x0,7 h - blu

Assorbono gli urti.
Antiscivolo, igieniche
e lavabili.



10013

stuoia STRETCH cm.140x60x0,4 h

10062

stuoia pieghevole in polietilene
bicolore cm.180x50x0,8 h

Pivilex

Indicato per rivestire e/o attrezzare grandi superfici in quanto morbido, robusto e lavabile. Per il fissaggio permanente al suolo è consigliato l'uso di nastro biadesivo rimovibile (art. 08319)

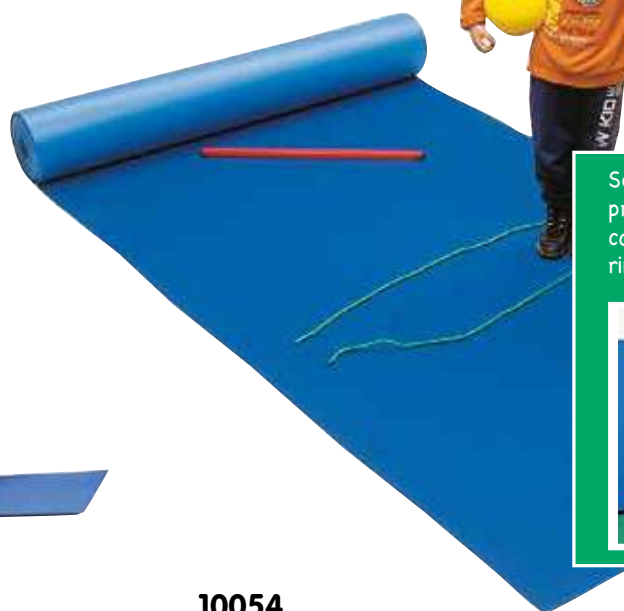

Se utilizzato come
protezioni murali si
consiglia nastro biadesivo
rimovibile 08319



10053

tappetino PIVILEX cm.140x70x0,5 h

10054

tappetino PIVILEX cm.140x0,5 h (vendita al metro lineare)

556 Movimento e psicomotricità

Tappeto in feltro

Tappeto in fibra polipropilenica al 100%, pelo raso, con fondo antiscivolo con ventose in elastogomma "GECO". Leggero e resistentissimo. Ideale per ingressi, corridoi, ma anche come superficie di gioco. Isola dal freddo del pavimento, consente ai bambini di giocare stando sdraiati per terra e di camminare anche a piedi nudi, non necessita di fissaggio ma resta fermo grazie alle ventose. Facilmente lavabile, igienico, ignifugo, può essere arrotolato con facilità e riposto ovunque.

- vendita al metro in rotoli altezza cm.100
- peso totale: 1800 gr./mq.
- impregnazione totale
- 100% PP

TAPPETO AL METRO - ROTOLO cm.100 h

- | | | |
|--------------|---|--------|
| 08711 |  | Blu |
| 08712 |  | Verde |
| 08713 |  | Rosso |
| 08714 |  | Grigio |

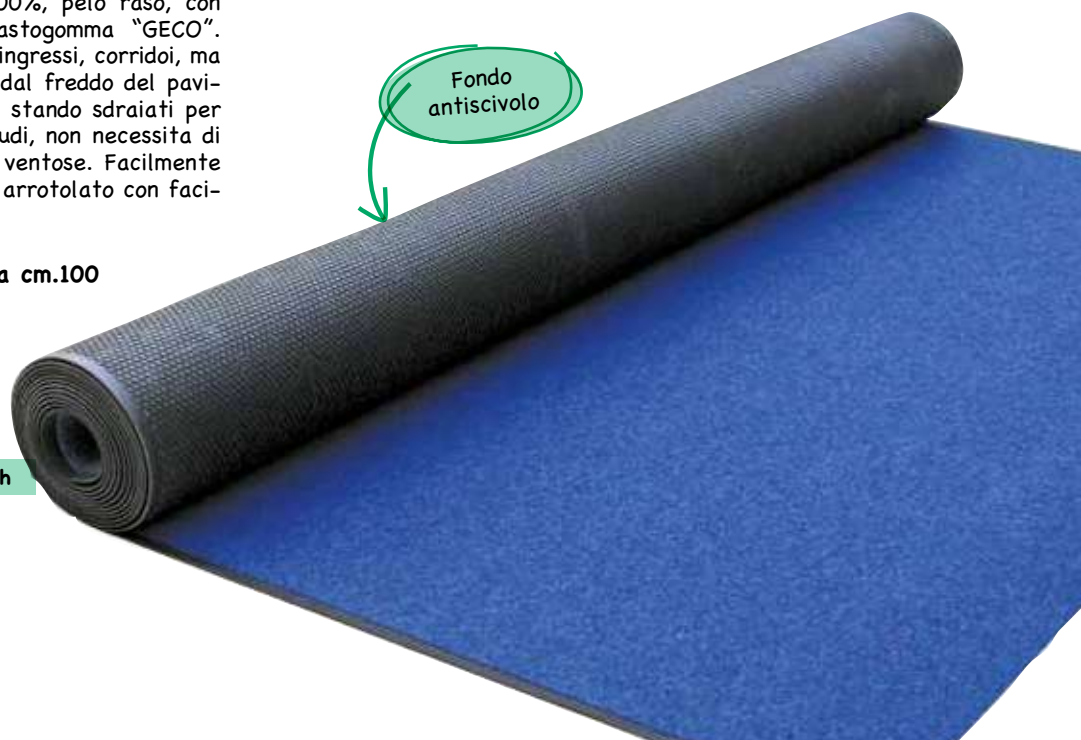

Tappeto "asciugapassi"

Tappeto con bordo e fondo in gomma antiscivolo.

- **Classificazione al fuoco:** Classe 2 appoggiato su supporto incombustibile
- **Composizione:** 100% fibra poliammidica
- **Destinazione:** grande traffico, ingressi, scuole, locali pubblici e abitazioni
- **Peso gr./mq:** 3060



09750

tappeto cm.60x90

09751

tappeto cm.90x150



Tappeto moquette

Pavimento tessile agugliato in fibra polipropilenica al 100%, pelo raso, ignifugo classe 1 (se incollato su supporto incombustibile), con fondo in PVC. Ideale per ambienti con traffico medio, ingressi, corridoi ma anche aule, sale gioco, eccetera. Grazie alla consistenza morbida e piacevole al tatto, la moquette è molto indicata negli ambienti scolastici e di gioco poiché isola dal freddo del pavimento, consente ai bambini di giocare stando sdraiati per terra e di camminare anche a piedi nudi; infine, in caso di caduta, attutisce l'impatto. Facilmente lavabile e spazzolabile con gli appositi prodotti, igienica, ignifuga. Per posare la moquette è sufficiente incollarla a una superficie piana, asciutta e pulita, utilizzando gli appositi collanti oppure il nastro adesivo removibile a presa forte (art. 08319).

- vendita al metro in rotoli altezza cm.100
- peso totale: 640 gr./mq.
- impregnazione totale
- 100% PP

TAPPETO cm.100 h

- 08729**  Blu
- 08730**  Verde
- 08731**  Rosso
- 08732**  Grigio



Vendita al metro
in rotolo

Nastro biadesivo Colla per moquette

Ideale per posare moquette, feltro e tappeti.

Idonea per la posa di tutti i pavimenti e rivestimenti tessili. Atossica e non infiammabile.



08319
nastro biadesivo removibile
mm.50x50 mt.

08824
collante adesivo Tack V4 - Kg.1

Maxi tappeto "Play Color"

Tappeto in fibra poliammidica, leggero, facile da utilizzare. Lavabile e spazzolabile con gli appositi prodotti, non lascia pelucchi.

- peso totale: 1500 gr./mq.
- spessore fibra: mm.6
- confortevole e sicuro
- igiene garantita
- isolamento termico e sonoro
- facilità di posa



RETTANGOLARE

● **11383** - cm.150x200 rigato

TONDO

● **11384** - ø cm.200 - rigato



558 Movimento e psicomotricità

Tappeti

GARANZIE:

- Trattamento antispurco
- Antistatico
- Resistenza termica DIN 52612-0,09



turchese



verde



azzurro

mt.2x2

10110

mt.2x2 - turchese

10111

mt.2x2 - verde

10112

mt.2x2 - azzurro

mt.2x3

10113

mt.2x3 - turchese

10114

mt.2x3 - verde

10115

mt.2x3 - azzurro

Comodità e piacevolezza si fondono per regalare al piede sensazioni di comfort assolutamente uniche, grazie alla capacità di attutire i colpi ed alla qualità delle fibre tessili utilizzate. Il tappeto protegge inoltre le articolazioni ed aiuta a prevenire le possibilità di caduta.



Tappeti

GARANZIE:

- Comfort e sicurezza
- Igiene e pulizia nel tempo
- Isolamento termico e sonoro
- Facilità di posa
- Resistenza nel tempo

CARATTERISTICHE:

- Aspetto: tufting velluto 1/10 tinto in pezza con fondo in juta sintetica poliammidica
- Composizione: 100% fibra
- Peso felpa: 450 g./m2

10187

tappeto tondo ø cm.200
colore: rosso



10188

tappeto tondo ø cm.200
colore: celeste



Tappeti gioco

Tutti i tappeti sono realizzati con pregiato filato in poliammide al 100% e hanno un rivestimento in lattice antiscivolo. Ogni tappeto rappresenta un diverso scenario di gioco, ideale per stimolare la fantasia del bambino.



06960

tappeto stradale cm.133x95x3



12053

tappeto gioco "Villaggio" cm.140x200



12054

tappeto gioco "Città"
cm.95x133



12055

tappeto gioco "Metropoli"
cm.95x200



560 Movimento e psicomotricità

Tappeti soft vinyl "Percorso cittadino"

Soffice e confortevole, isola dal freddo, isola dai rumori e attutiscono eventuali cadute. Semplice da posare è igienico e antibatterico perchè facilmente lavabile.

**GARANZIA
5 ANNI**

Igienici,
antibatterici



06770

rotolo tappeto in vinyl mt.1x2

06771

rotolo tappeto in vinyl mt.2x2

06772

rotolo tappeto in vinyl per pavimentazione mt.2x25 (50 mq)

Tappeti soft vinyl "Pole position"

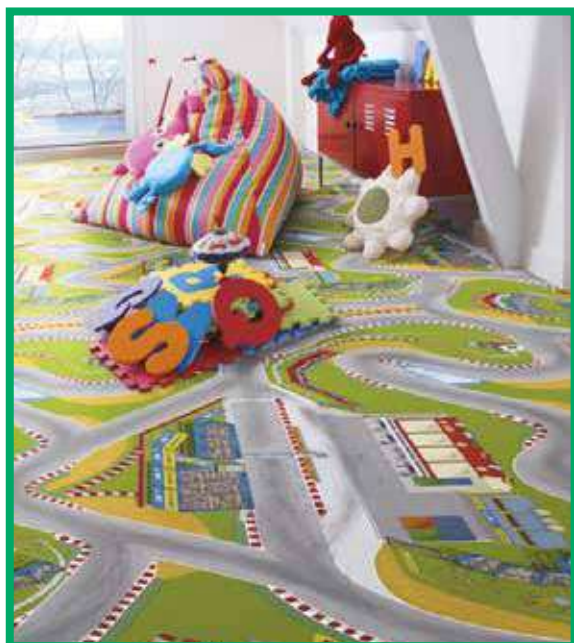

TAPPETO SOFT "POLE POSITION" - spessore mm.3,5

08362 - rotolo tappeto mt.2x1

08363 - rotolo tappeto mt.2x2

08364 - rotolo tappeto mq.50 (mt.2x25)

Tappeti soft vinyl "Città deserto"

Igienici,
antibatterici



TAPPETO SOFT "CITTÀ DESERTO" spessore mm.3

● **08359** - rotolo tappeto mt.1x2

08360 - rotolo tappeto mt.2x2

08361 - rotolo tappeto mq.50 (mt.2x25)

Grande tappeto "Il gioco dell'oca"

Tappeto in fibra poliammidica, leggero, facile da utilizzare. Lavabile e spazzolabile con gli appositi prodotti, non lascia pelucchi.

- peso totale: 1500 gr./mq.
- spessore fibra: mm.6
- confortevole e sicuro
- igiene garantita
- isolamento termico e sonoro
- facilità di posa

11385

dimensioni cm.150x200



pag.598
dado
in gommaspugna

Grande tappeto "Campana" Tappeto "Quattro stagioni"

Tappeto in fibra poliammidica, leggero, facile da utilizzare. Lavabile e spazzolabile con gli appositi prodotti, non lascia pelucchi. L'illustrazione riproduce l'omonimo gioco.

- peso totale: 1500 gr./mq.
- spessore fibra: mm.6
- confortevole e sicuro
- igiene garantita
- isolamento termico e sonoro
- facilità di posa

Tappeto in fibra poliammidica, leggero, facile da utilizzare. Lavabile e spazzolabile con gli appositi prodotti, non lascia pelucchi.

- peso totale: 1650 gr./mq.
- altezza pelo: mm.6
- 100% fibra poliammidica
- confortevole e sicuro
- igiene garantita
- isolamento termico e sonoro
- facilità di posa



11388

dimensioni cm.150x200



11386

dimensioni cm.100x100

Tappeto effetto parquet

TAPPETO SOFT VINYL "EFFETTO PARQUET" spessore mm.3

09414

pavimento mt.2 altezza
(vendita al mq. minimo: multipli di 2mt.)

09415

rotolo mt.30x2 altezza (totale 60 mq.)

10232

rotolo tappeto mt.2x2

10233

rotolo tappeto mt.2x3



Tappeto stradale

Morbido tappeto componibile formato da 81 tessere in EVA. Costituisce un'ottima base da gioco per i bambini, proteggendoli dal freddo e dalla durezza del pavimento. Antiscivolo, lavabile con acqua.



Esempio formato da 4 tappeti da cm.92
uniti = cm.184x184

* Più tappeti
per creare una
grande città!



05175

tappeto cm.92x92 composto da 81 tessere
spessore cm.1,4

Tappeto puzzle "Mondo"

Tappeto in morbida EVA composto da grosse tessere puzzle incastrabili, in modo da formare un grande puzzle che raffigura il planisfero. Ideale come base da gioco, il tappeto consente inoltre di affinare le capacità psicomotorie e di imparare le prime nozioni di geografia.

PN200

confezione 54 mattonelle EVA
puzzle montato: cm.60x90 - spessore cm.1,2



Mattonelle in EVA

Morbide mattonelle in EVA combinabili come puzzle per creare tappeti adattabili a superfici di varie dimensioni.

Le mattonelle sono leggere, insonorizzanti e termoisolanti.

Facili da pulire anche solo con acqua.



NUOVO INCASTRO "LINK"

PUOI COMBINARE
LE MATTONELLE DA CM.50
CON QUELLE DA CM.100

cm.50x50 - 1 spessore

ogni mattonella è fornita di bordo
minimo acquistabile 4 pezzi per colore

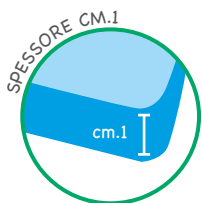

- 12434/051 ● giallo
- 12434/052 ● rosso
- 12434/053 ● verde
- 12434/054 ● blu

cm.100x100 - 1 spessore

ogni mattonella è fornita di bordo
minimo acquistabile 2 pezzi per colore

- 12434/101 ● giallo
- 12434/102 ● rosso
- 12434/103 ● verde
- 12434/104 ● blu

cm.50x50 - 1,5 spessore

ogni mattonella è fornita di bordo
minimo acquistabile 4 pezzi per colore

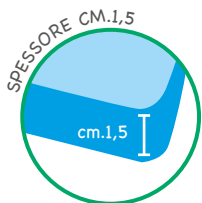

- 12442/051 ● giallo
- 12442/052 ● rosso
- 12442/053 ● verde
- 12442/054 ● blu

cm.100x100 - 1,5 spessore

ogni mattonella è fornita di bordo
minimo acquistabile 2 pezzi per colore

- 12442/101 ● giallo
- 12442/102 ● rosso
- 12442/103 ● verde
- 12442/104 ● blu

BICOLORE

cm.50x50 - 2,5 spessore

ogni mattonella è fornita di bordo
minimo acquistabile 4 pezzi per colore

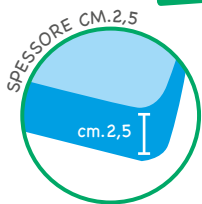

- 12450/051 ● rosso/blu
- 12450/052 ● giallo/verde

BICOLORE

cm.100x100 - 2,5 spessore

ogni mattonella è fornita di bordo
minimo acquistabile 2 pezzi per colore

- 12450/101 ● rosso/blu
- 12450/102 ● giallo/verde



cm.100x100 - 1,5 spessore

12442/4

set pz.4 mattonelle complete di bordi
assortite nei colori 



Tappeti componibili

Con queste confezioni di mattonelle in EVA a incastro é possibile comporre tappeti ad alto assorbimento d'urto delle dimensioni e forme desiderate: dal piccolo tappetino ginnico al grande tappeto per giochi di gruppo. Numeri, lettere e figure sono estraibili e riposizionabili. Spessore 1,4 cm. Superficie antiscivolo, lavabile con acqua.

6203

confezione 15 mattonelle numeri e figure (in EVA)
cm.30x30 - spessore cm.1

6204

confezione 26 mattonelle alfabeto (in EVA)
cm.30x30 - spessore cm.1



Percorso componibile "Jumpy"

Composto da 10 coloratissime mattonelle numerate, incastrabili tra loro, e da 2 dischetti. Il tutto è prodotto in morbidissima EVA. Jumpy affina le capacità di coordinazione occhio-piede, l'equilibrio e il controllo degli arti inferiori.

FM827/1

confezione 10 mattonelle (in EVA) cm.30x30
spessore cm.1,4 + 2 dischetti



Mattonelle "Effetto legno"

Mattonelle in EVA incastrabili tra loro. Consentono di comporre un tappeto adattabile a superfici di varie dimensioni, particolarmente indicato per fare ginnastica e per rivestire i pavimenti di asili nido, scuole materne ecc. Questo materiale assorbe gli urti, quindi protegge le articolazioni in caso di caduta. Le mattonelle possono anche essere fissate al muro (verniciato a smalto) con del nastro biadesivo oppure con colle siliconiche, universali o colle a caldo.

06608

confezione 4 mattonelle (in EVA) effetto legno
cm.60x60x1 h, densità: 120 kg./mc
bordi e angoli inclusi



Materiale atossico e ignifugo.

566 Movimento e psicomotricità

Arrampicata/free climbing

La parete per arrampicate, in robustissimo legno lamellare antischeggia, una volta fissata alla spalliera viene utilizzata per esercizi di coordinazione ed equilibrio, percorsi ludici modulari... È consigliabile posizionare una pavimentazione antitrauma nell'area sottostante la struttura.

Scala spalliera

Resistente e stabile spalliera in legno massello multistrato. Ancorata alla parete consente al bambino di arrampicarsi ed esercitare la propria coordinazione motoria.



04762 - scala spalliera cm.91x180 h

08908 - scala spalliera cm.91x250 h



08907

parete per scalata cm.77x160 h
da applicare alla spalliera (art.04762 e 08908)
+ 6 appigli per scalata inclusi

Appigli per arrampicata/free climbing

Forma ergonomica, priva di parti spigolose. Possono essere applicati sulle strutture per scalata al fine di realizzare itinerari motori e percorsi sempre nuovi.

08738

6 appigli in plastica

08739

12 appigli in plastica



Palestra

Palestra in legno per bambini dai 3 ai 12 anni di età.

Palestra 3 in 1

11194

palestra 3 in 1 cm.142x142x125 h
completa di materassino (verde/rosa)
cm.103x103x6 h



LATO 1

- pannello corda
- pannello scalata a pioli



RUOTA LA STRUTTURA PER UTILIZZARE IL LATO CON L'ARRAMPICATA DESIDERATA!



LATO 2

- pannello arrampicata



LATO 3

- pannello rete

Asse d'equilibrio 3 in 1

11195

asse cm.225x9x4,5 h + due basi cm.35x35x35
regolabile in due altezze (materassino escluso)



Asse regolabile in due altezze



10088



seduta
cm.28x20

Scivolo

Montato su una sola base è utilizzabile
come **SCIVOLO** (spalliera esclusa)



10315

Altalena

Montato al centro di una base è utilizzabile
come **ALTALENA**

Asse ginnica



11421

asse ginnica cm.200x30x11 h

Asse ginnica adattabile
sia alla palestra 3 in 1
sia alla spalliera

pag.548
cuscini



Scale e pareti

In legno pregiato antimuffa e antisceggia, trattato per resistere agli agenti atmosferici. Le pareti sono attrezzate per differenti esercizi di arrampicata. Indicata per bambini dai 3 ai 12 anni di età.

INCLUDONO LE 4 STAFFE PER ANCORAGGIO A MURO (TASSELLI ESCLUSI)



- **11197**
scala spalliera cm.95x200 h
- **11196**
scala spalliera cm.90x200 h
(utilizzabile anche come scala
per arrampicata con l'art.11197)

- **11198**
scala con pioli cm.200 h
(spalliera esclusa)

- **11199**
scala cm.200 h (spalliera esclusa)

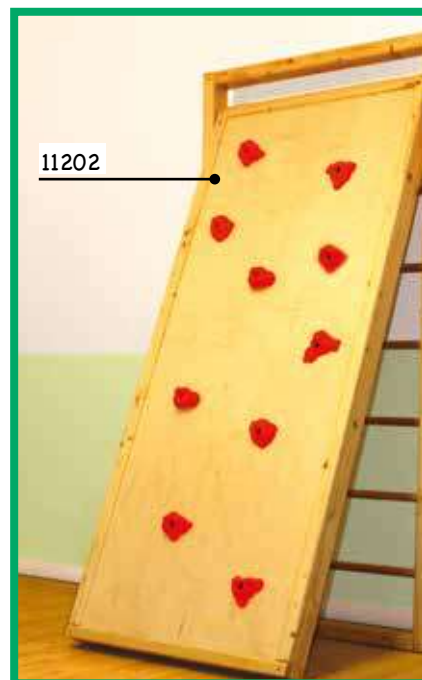

- **11200**
parete con corda e bastone cm.200 h

- **11201**
parete con corda cm.200 h

- **11202**
parete per scalata cm.200 h (spalliera
esclusa) + 12 appigli per scalata inclusi
(utilizzabile con spalliera art.11197)

Per realizzare la composizione a "T"

Sono necessari:

- 1 scala spalliera art.11197
- 1 parete con corda e bastone art.11200
- 1 parete con corda art.11201
- 1 Kit per composizione a T art.12251

(In ogni scala/parete sono incluse
4 staffe per l'ancoraggio a muro)



2 ANGOLI IN METALLO



4 VITI



2 LASTRINE AD ANGOLO



Asse d'equilibrio

Stabile e resistente, l'asse di legno può essere utilizzata sia dal lato piatto che da quello convesso. La larghezza dell'asse sulla parte piana (cm.10) consente il totale appoggio della pianta del piede del bambino, dandogli sicurezza e stabilità. Sulla parte curva è comunque possibile il pieno appoggio dell'arco plantare. La stabilità dell'asse è assicurata da pratici pioli a incastro.



04759

asse d'equilibrio
(in legno) mt.3



Altalena per camminamento

Struttura che consente ai bambini di migliorare l'equilibrio e la coordinazione psicomotoria.
+ 3 anni.

10259

altalena per camminamento
(in legno) cm.170x17x26/32



07820

bilico/ponte (in legno)
cm.84x42x14,5 h



10258

bilico/ponte (in legno)
cm.170x45x36 h



10390

arrampicata semicircolare
(in legno) cm.100x45x50



10391

arrampicata triangolare
(in legno) cm.90x45x80

Pedane ginniche

Pedane (in legno) con top ricoperto in moquette. Indicate per percorsi ginnici nelle palestre, centri di riabilitazione, centri ricreativi...

10302

set completo di 4 pedane (in legno)



10298

rampa (in legno)
cm.48x58x36 h

10301

pedana (in legno)
cm.48x48x36 h

10300

pedana (in legno)
cm.48x48x24 h

10299

pedana (in legno)
cm.48x48x12 h

Attrezzi ginnici

04760

arco (A) cm.62,5x76,5x62 h
Può essere utilizzato singolarmente come dondolo o abbinato all'asse di collegamento per realizzare originali percorsi.

04761

asse di collegamento arco (B) cm.15x185x6 h
Asse (in legno) ideale per collegare due archi o come supplemento al dondolo, per creare una struttura completa e divertente.

04763

scivolo (D) cm.33x180 (in legno) abbinabile a qualsiasi struttura del percorso motorio.

04764

scala di collegamento (C) cm.30x145x6 h



Attrezzi ginnici

Tutte le attrezzature, in robusto legno, non sono strutturate, ossia non hanno un unico uso prestabilito. È possibile utilizzarle in vari modi, per raggiungere diversi obiettivi e per consentire ai bambini una libera interpretazione di movimento, creando di volta in volta percorsi ginnici sempre originali, con vari gradi di complessità. Indispensabili in ogni palestra, centro di riabilitazione, centri ricreativi...

09931

attrezzo ginnico (in legno)
cm.64x75,5x44 h
(vedi top art.09938)

09932

attrezzo ginnico (in legno)
cm.88x75,5x55 h
(vedi top art.09937)

09933

attrezzo ginnico (in legno)
cm.112x75,5x69,5 h
(vedi top art.09936)

09934

attrezzo ginnico (in legno)
cm.138x110x84 h
(vedi top art.09935)

TOP PER ATTREZZI GINNICI

09935

top (per attrezzo art.09934)
cm.86x71x1,8 h

09936

top (per attrezzo art.09933)
cm.69x71x1,8 h

09937

top (per attrezzo art.09932)
cm.52x71x1,8 h

09938

top (per attrezzo art.09931)
cm.35x71x1,8 h



09931
con top removibile art. 09938



09934

Percorso "Ruota gigante"

Percorso motorio in polietilene ad alta densità. Smontabile in 4 parti, utilizzabili per creare percorsi sempre diversi che promuovono l'attività fisica e lo sviluppo di equilibrio e coordinazione motoria. Indicato anche per ambienti esterni. Età consigliata: 3/7 anni.



11234

percorso "Ruota gigante" ø cm.145
altezza cm.45



Pietre del fiume

Permettere ai bambini di sviluppare la loro coordinazione muscolare e il senso dell'equilibrio attraverso il gioco. Questi accessori triangolari simili a pietre da guado hanno lati con pendenze variabili che offrono diversi gradi di difficoltà. L'obiettivo è saltare da una pietra all'altra senza toccare il suolo. Questo gioco sviluppa il controllo del movimento, la stima visiva delle distanze, la coordinazione dei movimenti e l'equilibrio del corpo.

NOVITA'

12880

pietre del fiume set 11 pezzi



Trampoli

Superficie in gomma zigrinata grazie alla quale il bambino può giocare senza scivolare e senza fare rumore. Nella fase di produzione, la gomma zigrinata viene fusa con il trampolo, rendendola parte integrante di esso. In questo modo la gomma non rischia di staccarsi, e il bambino può giocare in assoluta sicurezza. I manici dei trampoli, in resistente corda gommata, sono adattabili alla statura del bambino.

17001

coppia trampoli con manici



ANTISCIVOLO



ANTIRUMORE



Trampoli

09616

set 2 semisfere/trampoli
in faggio \varnothing cm.12x4 h
con gomma antiscivolo
e corda con impugnatura



Tavola per coordinazione motoria

09434

tavola (in legno)
cm.25x50 x mm.18 spessore



Trampoli

09623

coppia di trampoli (in legno)
cm.130 altezza



Semisfere per equilibrio

Ideali per affinare equilibrio e coordinazione motoria.
Superficie antiscivolo GECO
con ventose in gomma.



cm.12x4

09579

set 4 semisfere per equilibrio in faggio
con antiscivolo - \varnothing cm.12x4 h

576 Movimento e psicomotricità

Pedana basculante

In legno naturale, resistente, consente al bambino di mantenersi in equilibrio sia in posizione seduta, sia in ginocchio o in piedi, a seconda dell'età e delle abilità motorie. Consigliata per bambini di età non inferiore ai 3 anni.



07818

pedana basculante (in legno)
cm.43x30x15,5 h



10256

pedana basculante (in legno)
cm.41x50

Carrello con ruote

Questi giochi realizzati in legno consentono di lavorare molto con l'equilibrio, la concentrazione e la coordinazione motoria.



09621

carrello (in legno) con ruote
cm.54x35x9 h

● **09622**

disco (in legno) con ruote \varnothing cm.50



Disco oscillante

Questo gioco interamente realizzato in legno consente di lavorare molto con l'equilibrio, la concentrazione e la coordinazione motoria. Dotato di superficie antiscivolo GECCO.



parte laterale art. 09241



09241

disco oscillante (in legno) \varnothing cm.30

Gioco delle biglie

Questo gioco in legno stimola il bambino sollecitando la sua attenzione. Il bambino deve posizionare i piedi sui lati della tavola e controllare il movimento delle biglie che rotolano nelle scanalature.



parte laterale art. 09243

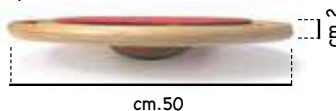

09242

pedana (in legno) con pista
disco \varnothing cm.40



09243

pedana (in legno) con pista
disco \varnothing cm.50



parte laterale art. 09244



09244

pedana (in legno) con spirale
per biglie disco \varnothing cm.50



Cerchi didattici

Tutti i prodotti riportati di seguito sono in plastica colorata atossica, ideale sia per ambienti interni che per esterni, e possono essere collegati l'uno con l'altro. In questo modo è possibile realizzare percorsi motori sempre nuovi.

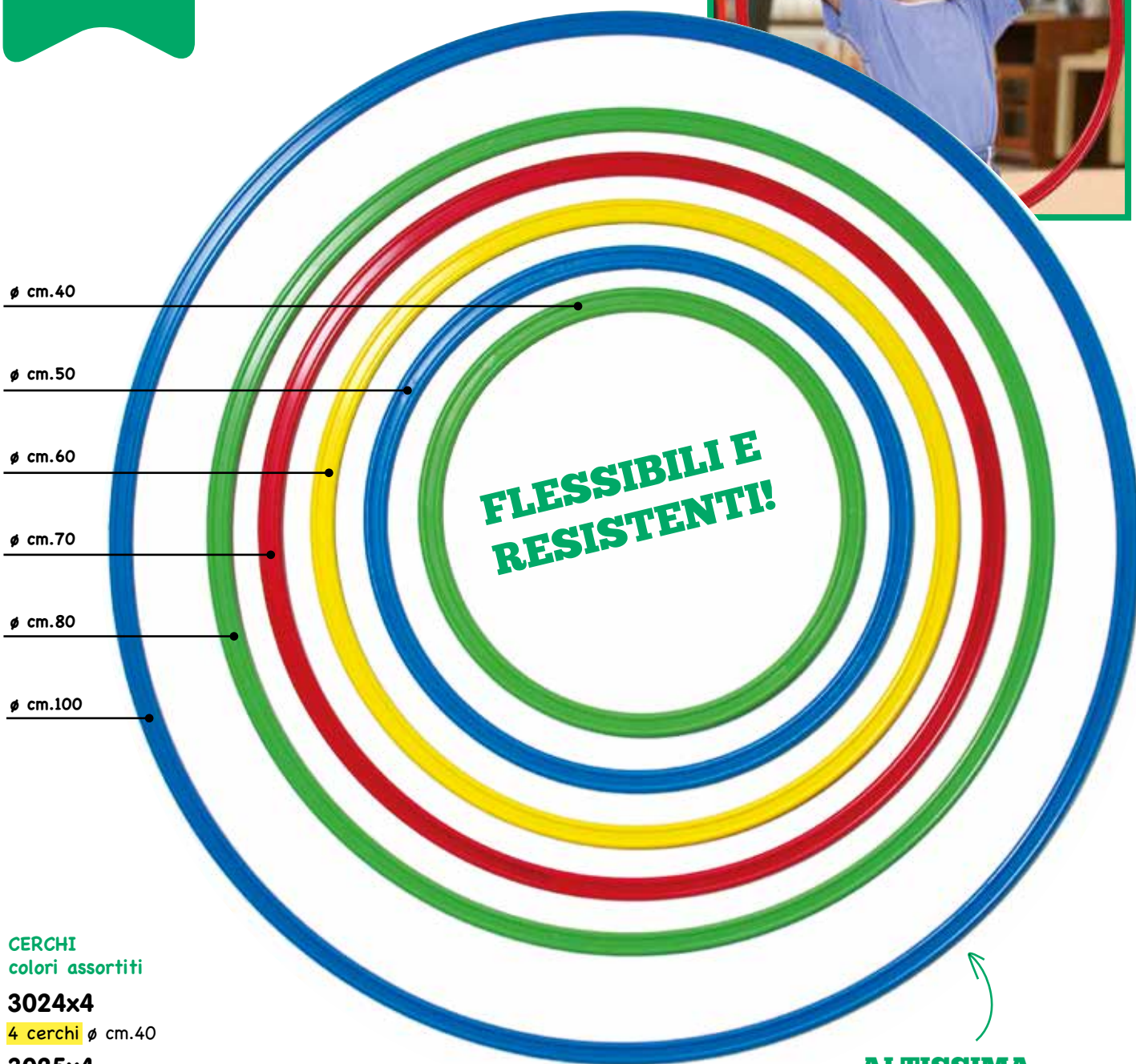

CERCHI
colori assortiti

3024x4

4 cerchi ø cm.40

3025x4

4 cerchi ø cm.50

3026x4

4 cerchi ø cm.60

07991x4

4 cerchi ø cm.70

07992x4

4 cerchi ø cm.80

07993x4

4 cerchi ø cm.100

SET CERCHI

3026/3x4

4 set di cerchi didattici (totale 12 cerchi)
Ogni set è composto da un cerchio ø cm.40, un cerchio ø cm.50, un cerchio ø cm.60 assortiti nei 4 colori

07994x4

4 set di cerchi didattici (totale 16 cerchi)
Ogni set è composto da un cerchio ø cm.60, un cerchio ø cm.70, un cerchio ø cm.80, un cerchio ø cm.100 - assortiti nei 4 colori

**ALTISSIMA
QUALITÀ**

MADE IN ITALY



578 Movimento e psicomotricità



Bastoni didattici

minimo acquistabile: 4 pezzi della stessa misura (uno per colore)

BASTONE ANTIURTO
per percorsi psicomotori
4 colori assortiti

3004x4

4 bastoni cm.40

3005x4

4 bastoni cm.50

3006x4

4 bastoni cm.60

3008x4

4 bastoni cm.80

3010x4

4 bastoni cm.100

3015x4

4 bastoni cm.150

BASTONE IN LEGNO
Ø MM.26 VERNICIATO AL NATURALE
CON TERMINALI ARROTONDATI

09246x4

4 bastoni cm.60

09247x4

4 bastoni cm.80

09248x4

4 bastoni cm.100



Coni didattici

2406x12

12 coni per percorsi con 12 fori per abbinare bastoni didattici, ecc...
cm.35 h - colori assortiti

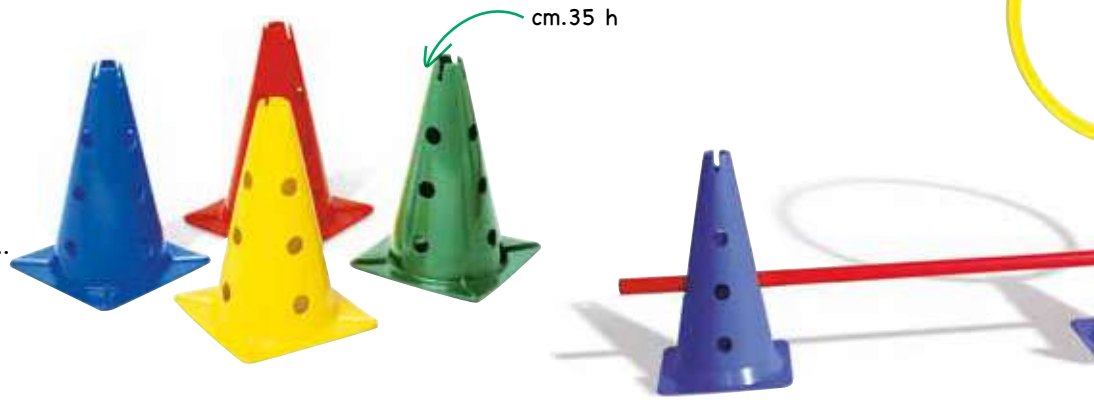

cm.35 h



cm.50 h



cm.50 h

08032x8

8 coni per percorsi con 16 fori
cm.50 h - colori assortiti

● 08059x8

8 coni per percorsi senza fori
cm.50 h - colori assortiti



2408

assortimento per percorsi motori, contiene: 6 coni per percorsi (cm.35 h) + 6 bastoni (cm.100 h) colori assortiti

11596

11595

11598

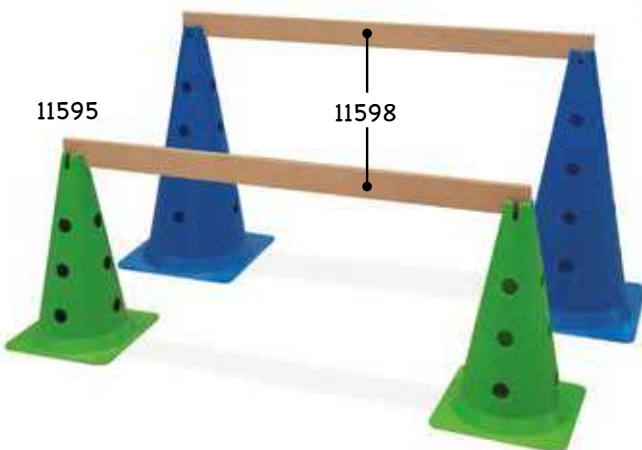

11595

set 6 coni cm.35 h + 3 asticelle cm.80

11596

set 6 coni cm.50 h + 3 asticelle cm.80

11598

busta 3 asticelle (in legno) cm.5x80

580 Movimento e psicomotricità

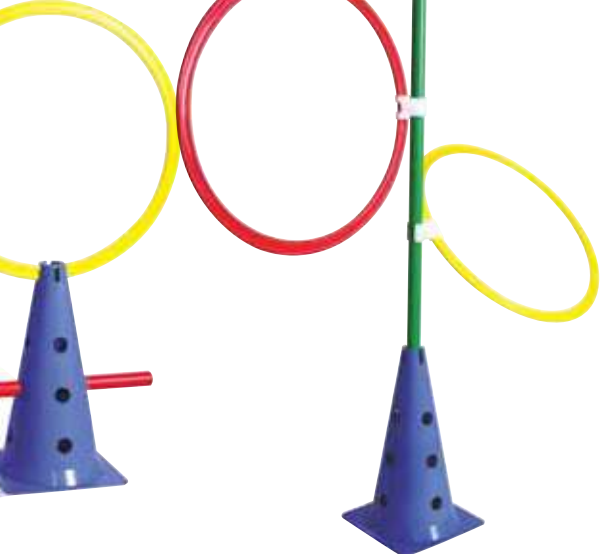

Ganci portacerchi e bastoni

| A | B | C | D | Ø | Ø1 |
|----|----|----|----|----|----|
| mm | mm | mm | mm | mm | mm |

200 16 70 290 5 16

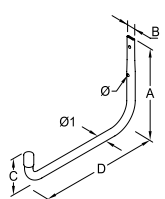

08728



PRATICI
E ROBUSTI

| A | B | C | Ø | Ø1 |
|----|----|----|----|----|
| mm | mm | mm | mm | mm |

200 280 150 5,6 16

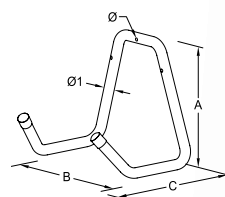

08727



08728x2

2 ganci portata 50 Kg

08727

gancio doppio portata 50 Kg

Roto-ganci per percorsi

Consentono di collegare in differenti modi i cerchi e i bastoni per poter creare percorsi motori sempre nuovi e originali, con diversi gradi di complessità a seconda dell'età e delle capacità dei bambini.



08024

set 12 roto-ganci
per bastone/bastone



08025

set 12 roto-ganci
per bastone/cerchio



04960

set 24 roto-ganci
(16 per bastoni e 8 per cerchi)

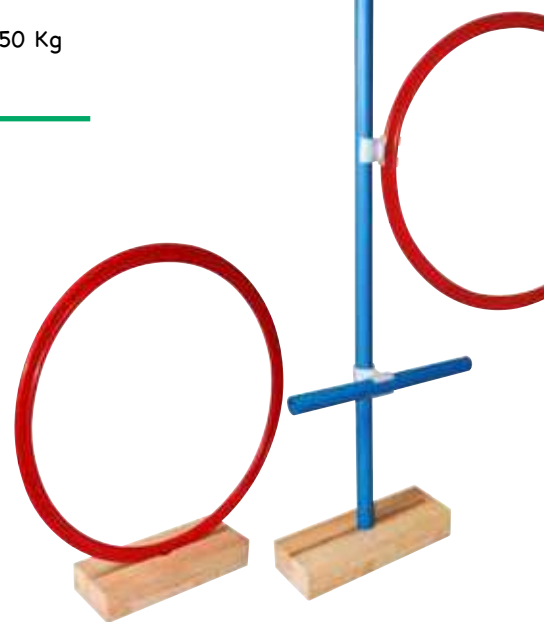

11514

ceppo (in legno) porta cerchi e
bastoni didattici
cm.25,5x9,5x5 h

Ostacoli per percorsi



09159

set 50 coni a disco \varnothing cm.20
con portadischi
5 colori assortiti



09158

set 40 coni soft
 \varnothing cm.18,5 materiale flessibile
5 colori assortiti



09160

set 10 coni per percorsi
cm.23 h
con numeri da 1 a 9



09161

cono soft per percorsi cm.23 h
materiale flessibile

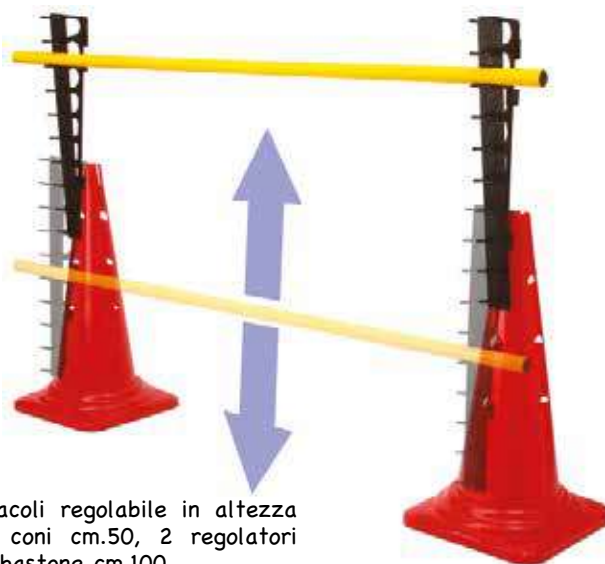

09164

set per ostacoli regolabile in altezza
contiene: 2 coni cm.50, 2 regolatori
d'altezza, 1 bastone cm.100

Ostacoli in plastica per attività ginniche e percorsi motori, privi di spigoli o parti acuminata. Ideali sia per interni che per esterni. Regolabile in altezza a seconda delle necessità e dell'età dei bambini che lo utilizzano. Tre diverse altezze: cm.15, cm.23 e cm.29.

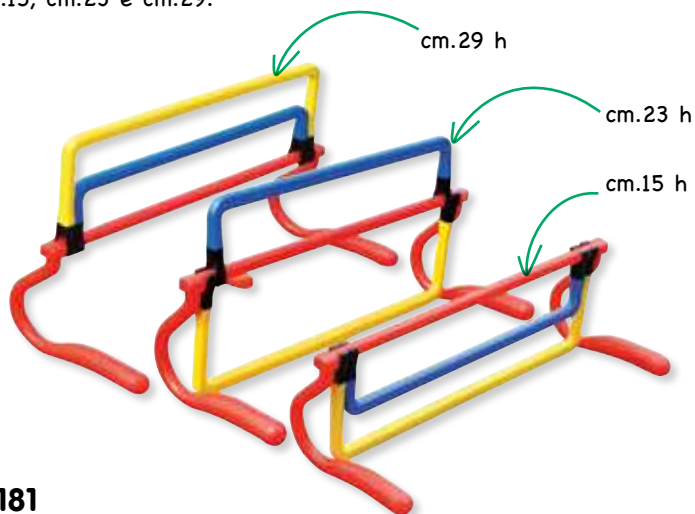

09181

ostacolo 3 in 1 regolabile in altezza



Mattoni in plastica

In plastica, facili da incastrare e combinare per realizzare costruzioni e percorsi motori. È possibile riempirli con acqua o sabbia, utilizzando poi gli appositi tappi (art.04788). **MATTONI** cm.12x24x6 h



1

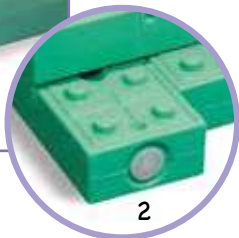

2

04788

tappi per mattoni
(in plastica)



Indicati per percorsi motori con cerchi e bastoni



10217

set 4 mattoni colori assortiti
(nei 4 colori base)

04785

CONFEZIONE SCUOLA 24 mattoni
colori assortiti (nei 4 colori base)



● **04961**

set 24 mattoni colore rosso scuro
(indicati per costruzioni realistiche)

I tappi hanno una duplice funzione:

- 1) antiscivolo, nel caso in cui il mattone venga utilizzato come base su cui i bambini devono esercitarsi;
- 2) se i mattoni vengono utilizzati come base per i segnali stradali, devono essere riempiti d'acqua o di sabbia. Per evitare la fuoriuscita del materiale, basterà applicare i tappi sui fori laterali.

Mattoni in cartone

NOVITA'

12946

mattone cm.15x7,5x7,5



NOVITA'

12947

mattone cm.15x15x7,5



F102x20

20 mattoni cm.30x15x7



I mattoni BLOCK, prodotti in cartone pesante, sono facili da montare e molto resistenti: il bambino può persino saltarci sopra, senza che essi subiscano danni. Grazie a questi mattoni, grandi e leggeri, il bambino può realizzare percorsi motori.



Percorsi motori

Un'utile gamma di accessori per costruire originalissimi percorsi motori. Tutti i prodotti sono in plastica colorata atossica, ideale sia per interni che per esterni, e possono essere collegati l'uno con l'altro in modo pratico e semplice. In questo modo è possibile realizzare percorsi sempre nuovi, la cui difficoltà aumenta a seconda dell'età e dell'abilità dei bambini.



88
PEZZI

04758

grande assortimento per psicomotricità
contenuto del set:

- 12 bastoni da cm.100
- 12 bastoni da cm.60
- 1 confezione da 24 roto-ganci
- 12 cerchi misure e colori assortiti
- 12 mattoni per psicomotricità
- 12 tappi antisdrucchiolo
- 4 corde colorate da mt.3



Assortimenti per creare
percorsi motori
sempre diversi!

72
PEZZI

10262

grande assortimento per psicomotricità
contenuto del set:

- 12 coni da cm.35
- 12 bastoni da cm.80
- 1 confezione da 12 roto-ganci
- 12 cerchi misure e colori assortiti
- 12 orme motorie piedi
- 12 orme motorie mani



Carrelli psicomotricità

Questi pratici e robusti carrelli in legno consentono di tenere sempre in ordine e a portata di mano l'attrezzatura indispensabile per realizzare i percorsi psicomotori: cerchi, bastoni, corde, palle ecc... Dotati di ruote, grazie alle quali è possibile spostarli.



04756

carrello psicomotricità vuoto
cm.50x115x90 h



04757

carrello psicomotricità completo cm.50x115x90 h
contenuto: 12 mattoni colorati, 4 palle ritmiche, 12 orme motorie, 4 corde colorate da mt.3 ciascuna, 12 cerchi assortiti in 3 misure e 4 colori, 8 bastoni didattici cm.80, 24 perni di collegamento, 1 palla con maniglia.

Robusto e pratico carrello in multistrato di betulla e massello. Completo di tutti gli strumenti indispensabili per realizzare i percorsi psicomotori. Dotato di ruote.



08785

carrello psicomotricità completo cm.60x70x70 h
contiene: 6 mattoni, 3 cerchi assortiti in 3 misure, 8 bastoni didattici cm.80, 4 coni a 12 fori, 4 corde colorate da mt.3 ciascuna, 2 palle ritmiche, 16 orme motorie (mano + piede), 1 confezione 24 roto-ganci (16 per bastoni e 8 per cerchi art.04960), 6 tappi per mattoni (art.04788)
In fondino e acciaio. Completo degli strumenti per realizzare i percorsi psicomotori. Con coperchio.

Set educazione stradale

04786

set completo per educazione stradale
la confezione comprende:

- 14 segnali stradali (cm.30x30)
- 12 mattoni con tappi (basi)
- 12 bastoni cm.100
- 24 perni
(per fissare i cartelli ai bastoni)

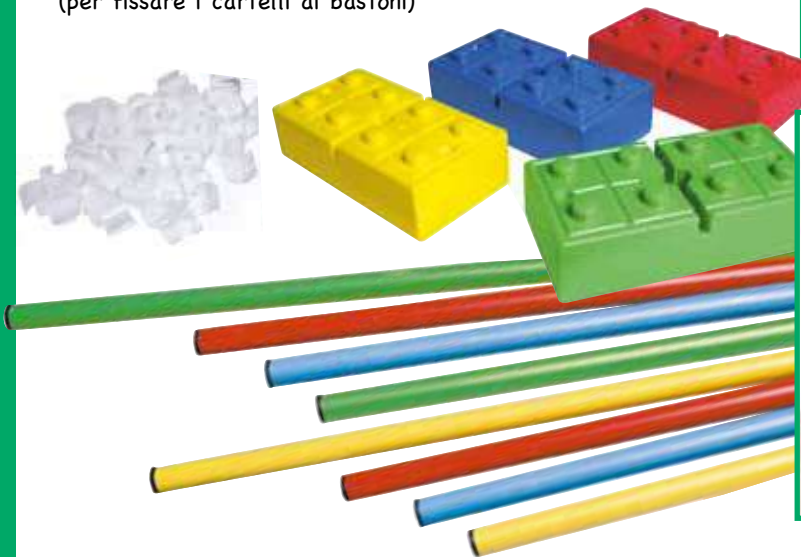

05097

confezione 14 segnali stradali
cm.30x30 circa + 24 perni
(per fissare i cartelli ai bastoni)



Domino stradale

Il gioco è composto da 20 tessere in legno (cm.6x12) su ognuna delle quali è rappresentato un cartello stradale e la spiegazione del significato di un altro cartello stradale. Il bambino dovrà abbinare le tessere in modo tale che a ogni cartello corrisponda la giusta spiegazione. Indicato per bambini di scuole elementari e medie inferiori.



07490

domino educazione stradale (in legno)
totale 20 tessere cm.6x12 in scatola di legno

Set segnali stradali

Pratica valigetta contenente tutto il necessario per insegnare ai bambini il significato dei vari cartelli stradali. I cartelli in legno, molto chiari e colorati, vengono posizionati sulle apposite basi e mostrati al bambino, che dovrà riconoscerli e spiegarne il significato.



09442

set 12 segnali stradali (in legno)

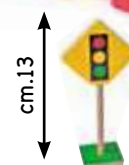

586 Movimento e psicomotricità



NOVITA'

12885

semaforo con luci cm.25x25x74 h

Funziona con 4 batterie AAA (non incluse).

Il semaforo può essere impostato automaticamente con due diverse modalità. Facile da assemblare.

NOVITA'

12886

set 8 cartelli stradali cm.25x25x82 h

Resistenti e impilabili, perfetti per insegnare ai bambini il codice della strada. Stampati su un solo lato. Utilizzabili sia all'aperto che al chiuso.

Semaforo per educazione stradale

04954

semaforo per educazione stradale, composto da: 1 bastone, 3 mattoni (base), 1 semaforo con 3 palette colorate estraibili cm.100 h

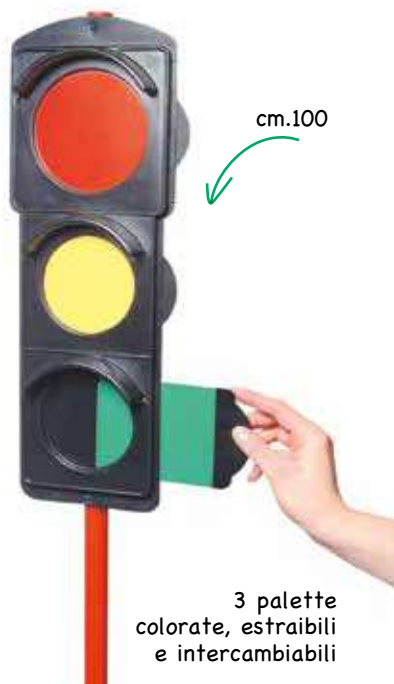

cm.100

3 palette colorate, estraibili e intercambiabili



pag.583
mattoni

Set segnaletica stradale

Elementi in morbido feltro antiscivolo per insegnare in modo efficace e divertente le prime regole dell'educazione stradale. Indispensabili anche per realizzare percorsi psicomotori sempre nuovi e originali: basterà disporre i vari elementi in modo da formare itinerari più o meno complessi che il bambino dovrà seguire senza fare errori.

09240

set completo per educazione stradale

Il set è composto da:

- 3 tappeti delle frecce cm.40x50
- 1 tappeto STOP cm.40x50
- 1 tappeto delle strisce pedonali cm.60x100



In feltro antiscivolo!



Set marcamento del suolo

Elementi in morbido feltro antiscivolo (struttura GECO con ventose in gomma). Utili per delimitare un campo da gioco, per segnalare il centrocampo, l'area di tiro ecc. Indispensabili anche per realizzare percorsi psicomotori sempre nuovi e originali. Spessore 2,5 mm.



08697

set marcamento del suolo 40 pezzi colori assortiti (16 strisce + 16 curve + 4 angoli + 4 frecce)

08693

set 8 STRISCE in (feltro) cm.7,5x37 colore blu

08694

set 4 ANGOLI (in feltro) cm.7,5x28 colore rosso

08695

set 8 CURVE (in feltro) cm.7,5x40 colore blu

08696

set 4 FRECCHE (in feltro) cm.7x37 colore rosso

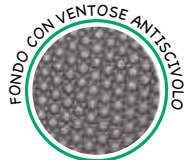

588 Movimento e psicomotricità

Forme tattili

Coloratissime forme tattili in feltro con superficie antiscivolo GECO, dotate di ventose in gomma che assicurano una perfetta aderenza al pavimento. Ideali per percorsi tattili e psicomotori al fine di sviluppare la coordinazione del bambino. Feltro antiscivolo con ventose in gomma. Spessore 2,5 mm.



08699

set 4 cerchi in feltro \varnothing cm.22
colori assortiti

08698

OFFERTA set 12 cerchi in feltro
 \varnothing cm.22 colori assortiti

08687

set 4 cerchi in feltro \varnothing cm.32
colori assortiti

08689

set 4 quadrati in feltro cm.32x32
colori assortiti

08691

set 4 triangoli in feltro cm.32/45°
colori assortiti

08688

set 12 feltri per percorsi motori,
cerchi \varnothing cm.32, quadrati, triangoli
colori assortiti

08686

OFFERTA set 12 feltri per percorsi motori
cerchi \varnothing cm.22, rettangoli, esagoni
colori assortiti

Strisce per percorsi

08746

confezione 12 strisce per percorsi
cm.5x100 - colore blu

08747

confezione 12 strisce per percorsi
cm.5x100 - colore rosso



pag.338
piastrelle tattili

Orme motorie

Orme in morbido feltro ideali per percorsi tattili e motori. Struttura antiscivolo GECO: la superficie che sta a contatto con il pavimento è dotata di piccole ventose in gomma che assicurano una perfetta aderenza e consentono ai bambini di non scivolare.

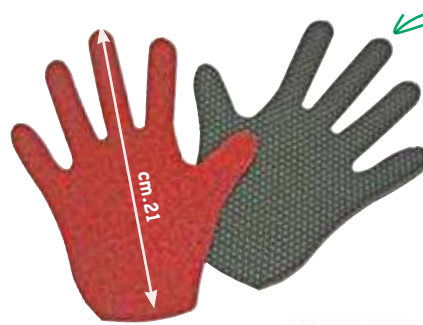
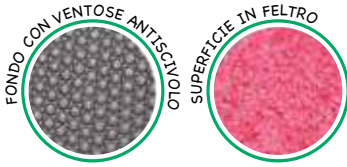

In feltro antiscivolo!

08704

valigetta cm.25x30, contiene:
12 mani (6 destre e 6 sinistre)
+ 12 piedi (6 destri e 6 sinistri)
colori assortiti

08680

confezione 12 orme motorie "mani"
cm.21x17 spessore mm.2,1
colori assortiti

08681

confezione 12 orme motorie "piedi"
cm.26x11 spessore mm.2,1
colori assortiti



Favoriscono nel bambino lo sviluppo della coordinazione occhio-piede, occhio-mano e del controllo degli arti inferiori e superiori. Prodotte in EVA, un materiale simile alla spugna ma molto più consistente, atossico, antiscivolo, resistente e facile da lavare.



MANI/PIEDI SPESSORE MM.0,5

6230

confezione 12 orme motorie "piedi"
cm.9x23 - 4 colori assortiti

6232

confezione 12 orme motorie "mani"
cm.15x19 - 4 colori assortiti



590 Movimento e psicomotricità

Corde



Corde per creare percorsi motori sempre nuovi!



1715

set 4 corde da 3 METRI ciascuna \varnothing mm.8 colori assortiti (4 colori base)

09976

set 4 corde da 10 METRI ciascuna \varnothing mm.8 colori assortiti (4 colori base)

09974

corda per equilibrio in polipropilene \varnothing cm.6x2 mt.

09975

corda di trazione in juta \varnothing cm.1,2x8 mt.



Tappeti a pioli

Composto da resistentissimi pioli di plastica che servono per lo sviluppo sensoriale del tatto e per la stimolazione dei piedi. Il bambino può correre, gattonare, camminare o saltare su questo originale tappeto, magari all'interno di un percorso tattile più complesso. Il tappeto a pioli può essere facilmente arrotolato e occupa poco spazio.



05289

set 4 tappeti a pioli per percorsi tattili singolo cm.30x148x3 h - colori assortiti

Clavette per giocolieri

Uno strumento di giocoleria per affinare la manualità e migliorare la prontezza di riflessi realizzando coreografie vivaci e spettacolari. Leggere e coloratissime, particolarmente indicate per bambini dai 7 anni di età.



08753

clavetta cm.52 peso gr.200 - colori assortiti

Mensola per clavette

In legno da mm.18. Bordi arrotondati.



08759

mensola in legno mm.300x1200 (30 posti)

Clave



09250

set 2 clave in legno verniciato al naturale
altezza cm.30

09251

set 2 clave in legno verniciato al naturale
altezza cm.35

09252

set 2 clave in legno verniciato al naturale
altezza cm.40

Piatti cinesi per giocoleria

Un gioco di equilibrio e concentrazione, poiché esso va tenuto in equilibrio e fatto roteare su di una bacchetta, inclusa nella confezione. Particolarmente indicati per sviluppare la motricità fine, la coordinazione occhio-mano, l'equilibrio e le abilità di concentrazione del bambino.



08754

set 6 piattini cinesi ø cm.23,5 + 6 bacchette
colori assortiti

MATERIALE
FLESSIBILE!



592 Movimento e psicomotricità

Bastone acrobatico

Il provetto giocoliere deve "gestire" il bastone acrobatico utilizzando le due apposite bacchette di controllo, e con esse deve cercare di farlo ruotare, dondolare, saltare...



08748

bastone acrobatico cm.64
+ 2 bacchette di controllo in materiale acrilico

Palline per giocoleria

Morbide palline per la coordinazione occhio-mano e la manualità in genere. Composte da grani di lino racchiusi in un resistentissimo rivestimento in Lycra.



08752

set 3 palle per giocolieri ø cm.6 - colori assortiti

Anelli giocoleria

Coloratissimi anelli fabbricati in plastica resistente e antiurto. Gli anelli costituiscono un passo successivo rispetto alle palline da giocoliere, per affinare le capacità di coordinazione occhio-mano, nonché la precisione nel lancio e nelle prese.



08750

confezione 6 anelli ø cm.24 assortiti

08751

confezione 6 anelli ø cm.32 assortiti

Diabolo

Il Diabolo viene appoggiato su un cordino legato all'estremità di due bacchette. Tenendo le bacchette una per mano e muovendole adeguatamente Diabolo si muove e salta verso l'alto.



08755

diabolo ø cm.10x10,7 h
bacchette cm.41x1,2 ø

08758

DVD "Come imparare a giocolare"

Kiwido

Nastri ritmici dotati di una pratica impugnatura in velluto, una cordicella di filo doppio ed un pesetto finale.



08749

coppia nastri ritmici (colori assortiti nell'imballo)

Foulard

Grazie ai fazzoletti colorati, in leggerissimo tulle, i bambini impareranno uno dei principali "trucchi" della giocoleria: scomporre i gesti e analizzarli uno per uno, concentrandosi di volta in volta sul lancio, sulla caduta, sulla presa ecc...



4 DRAPPI RITMICI IN RASO
100% POLIESTERE colori assortiti

10094
cm.75x75

10234
cm.140x140

08756
confezione 12 foulard
cm.65x65 in poliammide
colori assortiti



11449
nastro ritmico mt.4
completo di bastoncino
colori assortiti



10130
4 teli ritmici cm.280x250 colori assortiti



10201
4 cuscini motori in raso 100% cm.14x24 colori assortiti

Sacco psicomotorio

Uno strumento con cui i bambini potranno divertirsi a mimare gesti e movimenti, migliorando la propria coordinazione. Il materiale elastico con cui è realizzato il sacco permette al bambino di vedere all'esterno e ovviamente è traspirante.



07788
sacco psicomotorio. Realizzato in tessuto di lycra

Corsa nei sacchi

Avrete a disposizione sei sacchi numerati realizzati in robusto nylon, muniti di maniglie. Il bambino dovrà infilarsi nel sacco, aspettare il "via" e correre fino al traguardo. Un'attività ludica adatta per essere svolta all'aria aperta.



09155
set 6 sacchi per corsa colori assortiti - cm.65x71

594 Movimento e psicomotricità

Paracadute

Giocare con i paracadute consente di esercitare tutte le parti del corpo! Un modo divertente e innovativo per sviluppare la coordinazione fisica di base. I paracadute sono realizzati in coloratissimo poliestere leggero. Maniglie molto robuste e resistenti. Dotati di una corda spessa 10 mm cucita all'interno del bordo esterno: questo consente a un numero quasi illimitato di bambini di giocare contemporaneamente.



10139

paracadute piccolo ø mt.3,5 (8 maniglie)

10161

paracadute grande ø mt.5 (12 maniglie)



Tunnel motori

Favoriscono lo sviluppo dell'orientamento nello spazio, della coordinazione e delle capacità motorie. Particolarmente indicati all'interno di percorsi motori e ad ostacoli, ma anche per i bambini più piccoli. Utilizzabili sia all'interno che all'esterno. Lavabili con una spugna bagnata. Dotati di un telo di copertura in materiale cerato per evitare che si bagnino se lasciati all'aperto. Struttura in PVC rafforzato a "U", con barre in PVC da inserire nel tunnel ed agganciare alle strutture a "U".

07371

tunnel motorio dritto con struttura in PVC e rivestimento colorato in nylon cm.55x60 h, lunghezza cm.275

07372

tunnel motorio a croce con struttura in PVC e rivestimento colorato in nylon cm.275x275x55, larghezza cm.50 h + telo cerato



Giochi ricreativi



Birilli

09362

set 9 birilli + bocce



Mini luna park

09443

set 6 barattoli + 2 palline in schiuma di gomma espansa - colori assortiti



Bocce

08897

gioco delle bocce



Frisbee

08896

frisbee ø cm.22 colori assortiti
set 6 pezzi



Mega basket

08895

mega basket - set 2 pezzi



Hula hoop

08891

hula hoop ø cm.60 - set 6 pezzi

596 Movimento e psicomotricità

Gioco degli anelli

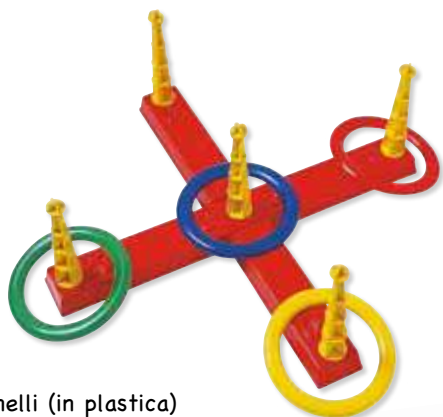

10015

gioco degli anelli (in plastica)
cm.49x12x6



SA059

gioco degli anelli (in legno) con 5 cerchi in corda
cm.56x56 - età 4+

Corda

08892/1x6

6 corde per saltare
con impugnatura in plastica
cm.244



Fischietto

09157

fischietto (in metallo)



Palloncini



08898

busta 100 palloncini \varnothing cm.24
colori assortiti

100 PALLONCINI \varnothing CM.24

conf./monocolore

10444 bianco

10445 giallo

10446 rosso

10447 verde

10448 azzurro

10449 rosa



08900

busta 100 palloncini per acqua \varnothing cm.8

08901

busta 100 palloncini da modellare cm.4x13

11319

gonfiatore elettrico per palloncini
cm.13x14x13 h

08902

pompa per palloncini



Palle in gommaspugna



3047



3040

3047

palla in spugna ad alta densità ø cm.7

3040

palla in gommaspugna ø cm.7



3041

palla in spugna ø cm.12
colori assortiti



3045

dado in gommaspugna
cm.15x15x15 - colori assortiti



3042

palla in gommaspugna
ø cm.20 - colori assortiti



3046

palla da rugby in gommaspugna
ø cm.17x24 h - colori assortiti

Portapalloni



08678

cesta cm.22x30x43 h
Ideale per riporre le
palline



08645

carrello cm.60x70x70 h
in tondino d'acciaio con
coperchio (chiudibile con
un lucchetto non incluso)



08104

carrello (in legno)
cm.52x70x60 h con ruote

Gonfiabili



09452

cavallo RODY gonfiabile colori assortiti
dimensioni cm.54x45
circonferenza alla sella max: cm.68
portata 45 kg - Anni: 3+



09450

palla con maniglia ø cm.45 giallo - portata 45 kg - Anni: 5+

09451

palla con maniglia ø cm.55 rosso - portata 70 kg - Anni: 7+

Palle prima infanzia

Palla morbida, leggera e resistente che consente di svolgere un'ampia gamma di esercizi che spaziano dal potenziamento muscolare alla ginnastica dolce. Facilmente gonfiabile a bocca, può essere ripiegata e portata con sé ovunque. Nella confezione è inclusa una brochure con alcuni esercizi esemplificativi. Peso sopportato: max. 80 kg



09444

set 3 palle ø cm.23 - colori assortiti
completo di cannucchia per il gonfiaggio



PALLA RITMICA GONFIABILE

09448

set 4 palle ø cm.17 gr.280
colori assortiti

09449

set 4 palle ø cm.18 gr.400
colori assortiti



09445

set 4 palle Maxi ø cm.5,5
colori assortiti

09446

set 4 Maxi Universal ø cm.12,5
colori assortiti



Palla Soffy

Questa palla si rivela uno specifico supporto per il recupero di patologie neurologiche ed ortopediche, nel trattamento della distrofia muscolare, per la ginnastica rieducativa ed antalgica, in attività motorie di potenziamento e mantenimento, nel metodo Pilates, nell'allenamento funzionale e nella preparazione atletica.

09447

palla Soffy \varnothing cm.45 colori assortiti



Palle terapeutiche

09455

palla terapeutica \varnothing cm.100 - colore rosso

09456

palla terapeutica \varnothing cm.65 - colore verde

La palla terapeutica si differenzia dalla classica palla per la fisioterapia per i piccoli rilievi presenti su tutta la sua superficie. Gli stimoli trasmessi da questa particolare superficie amplificano le sensazioni sensoriali e contemporaneamente forniscono un gradevole massaggio favorendo la circolazione sanguigna. Indicata nel recupero funzionale e nella ginnastica riabilitativa. Peso raccomandato: max. 120 kg



Palle riabilitative

09453

palla riabilitativa \varnothing cm.40x65 - colore rosso

09454

palla riabilitativa \varnothing cm.55x90 - colore giallo

Questa palla riabilitativa nasce dall'unione di due palle formando così un attrezzo che consente una estrema varietà di utilizzi associata ad una maggiore stabilità rispetto alla classica palla. Utilizzato da innumerevoli anni nel settore fisioterapico, ideale per tutti coloro che hanno difficoltà di coordinazione ed equilibrio, nelle persone affette da handicap, negli anziani, pensato anche per le scuole materne. Peso raccomandato: max. 120 kg

600 Movimento e psicomotricità

Accessori psicomotricità



09457

set 4 anelli ginnici \varnothing cm.18
Anelli colorati ideali per l'attività motoria e ricreativa, possono essere utilizzati per svariati giochi di gruppo stimolando prensilità, riflessi e coordinazione. Se immersi in piscina, galleggiano.



09459

set 4 anelli sensoriali \varnothing cm.17
Anello morbido e flessibile munito di rilievi che trasmettono un piacevole impulso sensoriale. Utilizzato per molteplici attività ludiche ed educative anche grazie ai 4 colori disponibili può altresì essere utilizzato in piscina, dove adagiandosi sul fondo consente di svolgere esercizi di apnea e recupero.



09458

set 2 cilindri sensoriali
(\varnothing cm.7,5x15 cad.)
Un piccolo rullo con morbide punte per un confortevole massaggio. Stimola la circolazione sanguigna a beneficio di tutto il corpo. Usato per massaggi plantari e dorsali, riflessologia ed esercizi di sensibilizzazione cutanea. È possibile gonfiare il prodotto con una pompa ad ago per ottenere la rigidità desiderata.



09460

set 6 palle sensoriali
 \varnothing cm.12 gr.100 - colori assortiti
Morbide e gradevoli al tatto e grazie ai rilievi sulla superficie forniscono una benefica stimolazione dei punti di pressione. Indicate per il massaggio e gli esercizi manipolativi.



09461

set 6 semisfere multiattività \varnothing cm.16x8 h
colori assortiti (riempibili con acqua)
Ideale per sviluppare l'equilibrio e stimolare la propriocettività, può essere utilizzato per creare percorsi avvalendosi dei diversi colori. Per una maggiore stabilità è possibile riempire la semisfera di acqua grazie al tappo posto sul fondo. Nell'apposito foro posto superiormente è possibile inserire un'asta di diametro standard (2,5 cm.)

Palle sensoriali

Uno strumento ideale nella fase dello sviluppo sensoriale ma anche nelle fasi successive finalizzate allo sviluppo di capacità motorie, concentrazione e centratura del sé. La consistenza morbida e gommosa invita il bambino alla manipolazione e all'esperienza motoria. Molto indicate per la gestione della rabbia e dell'ansia nei bambini: manipolando le morbide palline, il cervello si concentra sul movimento facendo diminuire la tensione. Consigliate anche per chi soffre di disturbi da deficit dell'attenzione/ipertattività, autismo e ansia.

Ipoallergeniche e completamente sicure, ecologiche, non contengono BPA, ftalati o lattice. Non sporcano né appiccicano, e sono molto resistenti. Età consigliata: dai 3 anni in su.

SCHIACCIA, STRIZZA E ALLUNGA

La palla torna sempre alla sua forma originale!



12936/2



12936/3



12936/1

NOVITA'

- Incredibile esperienza sensoriale/motoria!
- Disponibile in tre diversi formati

12936/1

palla sensoriale SMALL ø mm.43 (set 3 pezzi)

12936/2

palla sensoriale MEDIUM ø mm.65

12936/3

palla sensoriale LARGE ø mm.130



NOVITA'

- Cambia colore se strizzata, schiacciata, allungata!
- Alla fantastica esperienza sensoriale tattile, si unisce anche un'esperienza visiva che affascinerà i bambini

12940

palla sensoriale CAMALEON ø mm.65



602 Movimento e psicomotricità

Palle sensoriali

NOVITA'

- I bambini resteranno affascinati guardando come la massa colorata fuoriesce dai diversi fori della palla!

12941

palla sensoriale ATOMIC ø mm.65



NOVITA'

- Molteplici esperienze tattili/sensoriali grazie alla morbida superficie a "riccio"
- Facile da manipolare e afferrare

12939

palla sensoriale SHAGGY ø mm.65



NOVITA'

- Una soffice palla bianca riempita con impasto morbidissimo che ricorda la neve. La texture granulosa, la consistenza e il rumore prodotto da questa palla ricordano lo scricchiolio della neve quando la si calpesta. Un gioco multisensoriale che aiuta a sviluppare i muscoli della mano e delle dita e la coordinazione bilaterale, rilassando il bambino.

- Esperienza sensoriale – tattile – uditiva
- Aiuta a sviluppare la motricità fine e la forza della mano
- Allevia rabbia e tensione

12942

palla di neve sensoriale ø mm.65



NOVITA'

- I morbidissimi noodlies offrono un'esperienza di gioco sensoriale davvero unica. Questo gioco è indicato per bambini con tendenze ansiose e aiuta a promuovere concentrazione, attenzione e centratura. Non sporca e non appiccica.

Incoraggia calma e concentrazione

12943

12 nastri sensoriali cm.33 (5 colori assortiti)



Palloni da calcio



08904

pallone ø cm.23



09462

pallone in cuoio sintetico ø cm.21,5



08903

pallone SUPER TELE ø cm.23 colori assortiti

Porta da calcetto



09464

porta da calcetto (in metallo) cm.300x120x205 h
felaio in acciaio ø cm.3,8 verniciato a forno
corredata di 72 gancetti tendirete

Mini porta da calcio



07049

mini porta da calcio (in plastica) cm.91x63 h
Ideale anche per hockey e altre attività ginniche
(palla inclusa)

Soccer set



09179

set calcio composto da:
4 coni, 1 pallone,
1 pompa per palloni



604 Movimento e psicomotricità

Palla Rugby

*colori assortiti nell'imballo

pag.598
ceste portapalloni

NOVITA'

12934

palla rugby ø cm.28 (MISURA 5)

NOVITA'

12935

palla mini-rugby ø cm.21 (MISURA 3)



Palloni da volley

Pallone da volley in gomma termosaldata, con intelaiatura interna in nylon.



09474

pallone volley ø cm.20,5



09475

pallone volley ø cm.21,6



09473

pallone volley ø cm.20,5
colori assortiti nell'imballo

Pompa per palloni



09477

pompa con adattatore per
palloni da volley e biciclette

Aghi per palloni

09478

set 3 aghi in metallo di gonfiaggio



Set volano - Badminton

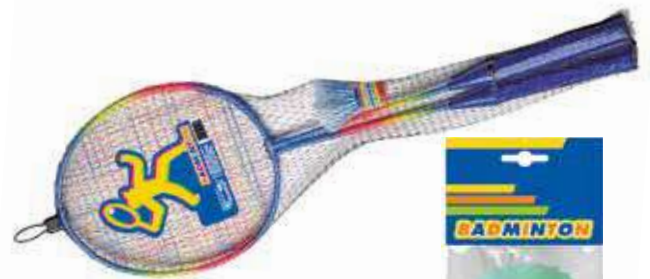

09480

set 2 racchette per volano con corde
in nylon + 1 volano con testa in Eva
racchetta cm.65,5

09482x3

3 set da 3 volani con testa in Eva



Pallacanestro/basket



09468

canestro Basket
con piantana trasportabile cm.150/200
altezza tabellone cm.74x50
canestro \varnothing cm.43



09469

canestro Basket All Stars
con piantana trasportabile
cm.190/260 altezza
tabellone cm.90x60
canestro \varnothing cm.46



09465

canestro Basket regolamentare \varnothing cm.46



09467

canestro Basket regolamentare
 \varnothing cm.46 con tabellone cm.90x60



09466

rete regolamentare per canestro

Palloni da basket



09470

pallone da basket \varnothing cm.27



09471

pallone da basket \varnothing cm.22
colori assortiti



09472

pallone da basket \varnothing cm.24
colori assortiti

Mini piantana basket

Pratico set contenente tutto il necessario per giocare a basket in ogni luogo! Facile da assemblare, stabile, resistente. Utilizzabile anche all'aperto.

09178

mini piantana basket MONSTER SLAM con cerchio in metallo con rete

Comprende:

1 palla da basket + 1 pompa

+ istruzioni per il montaggio

Piantana regolabile: cm. 138/166

Lunghezza tabellone: cm. 46,5

Palla: \varnothing cm.15

Trasportabile



Set "Rotor Spin"

Gioco di coordinazione e agilità.



09171

set "Rotor Spin"

contiene: 1 bastone cm.178, 2 racchette, 1 pallina

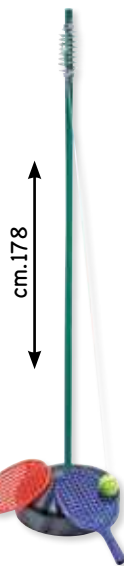

Set "Bollo Ball"



09175

set "Bollo Ball"

contiene: 1 stand, 6 bollo ball, istruzioni per il gioco

Gioco dei dardi



09176

gioco dei dardi

contiene: 2 bersagli, 4 dardi sicuri

Gioco del golf

09177

gioco del golf

contiene:

1 mazza da golf,

1 base, 6 palline



Set tennis



09481
set 3 palline da tennis



09172
set "impara il Tennis"
contiene: 1 set base, 2 racchette con filo, 1 pallina



Racchette da tennis



09479

09479
racchetta in alluminio con corde in budello
completa di fodera racchetta cm.69,5



09173

09173
set 2 racchette in plastica + 2 palline



09174

09174
set 2 racchettoni in plastica + 1 pallina
racchetta cm.41,5

08893
confezione 2 racchette in plastica
+ 1 pallina in spugna racchetta cm.54



08893

Set ping pong



08894

confezione 2 racchette da ping pong



09483

racchetta ping-pong EAGLE
gomma omologata



09484

set PING PONG, contiene: 2 racchette
da ping pong, 1 rete, 3 palline



09485

rete regolamentare per ping-pong



812



817

812

scatola 6 palline ping-pong \varnothing cm.3,5

817

scatola 6 palline ping-pong \varnothing cm.3,5



09486

scatola 100 palline ping-pong \varnothing cm.4

Calcio balilla



09488

calcetto CAMPUS (per interno)
cm.115x61x80 h - peso kg.26
Calcetto con aste telescopiche e
segnapunti, corredato di palline



09489

calcetto GOLEADOR (per interno)
cm.132x72x87 h - peso kg.43
Calcetto con aste telescopiche e
segnapunti, corredato di palline



09490

set 4 palline per calcetto

Accessori acqua e sabbia



07361

set 4 formine cm.10/12 animali marini

07362

set 4 formine cm.10/12 veicoli



08890x3

3 pale grandi cm.55
(in plastica)

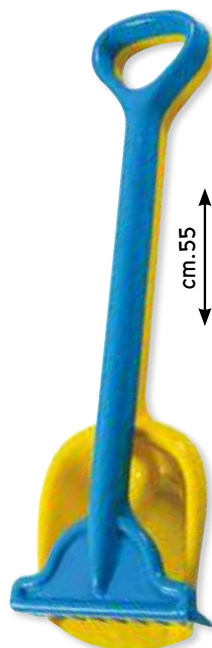

10012

pala + rastrello cm.55
(in plastica)



72300

pala cm.66 (in plastica)
colori assortiti nell'imballo



NOVITA'

12896

formine per sabbia DINOSAURO (10 pz)
Il set è composto da 10 formine per sabbia,
che insieme vanno a comporre un fossile di
dinosauro! Misure del dinosauro
completo: cm.73x30 circa



NOVITA'

12895

pala/vanga cm.18x12x6
colori assortiti

In robustissimo materiale plastico con
impugnatura ergonomica, ricorda la
forma della zampa di una talpa!



NOVITA'

12894

set 4 artigli escavatori cm.17x12
colori assortiti

Divertenti escavatori a forma di
artiglio, con impugnatura ergono-
mica. Forme e colori assortiti.



610 Movimento e psicomotricità



Made in Italy

SECCHIELLO GRADUATO

PIEGABILE E RESISTENTE



3030

3035



05307x4

4 setacci ø cm.19,5 tipo pesante
(indicato per secchiello art.3030)
4 colori base assortiti

3030x4

4 secchielli antiurto graduato
capacità 2 litri secchiello: ø cm.16x18 h
4 colori base assortiti

3035x4

4 palette antiurto cm.24
con impugnatura anatomica
4 colori base assortiti

10370

completo per sabbia
set per 8 bambini (24 pezzi totale)
Contiene: 8 palette, 8 secchielli,
8 setacci

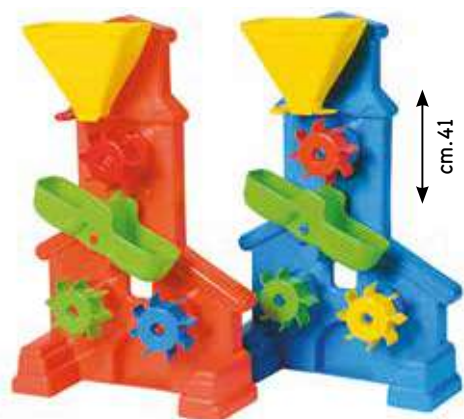

cm.41

10014

gioco ad acqua cm.41 h (in plastica)



10011

annaffiatoio Litri 1 (in plastica)
colori assortiti



08888

paletta spiaggia (6 pezzi)
(in plastica) colori assortiti

Cesta/sabbiera acqua e sabbia



2022

sabbiera a conchiglia
composta da 2 gusci.
cm.95x108x22 h



07711

sabbiera "rana" cm.82x94x39 h
con coperchio

05511

cesta/sabbiera
con coperchio
capacità: litri 65
cm.60x80x19 h



Palline

11231

conf. 500 palline assortite
ø cm.6,5

11232

conf. 100 palline assortite
ø cm.8,5



igienizzata
lavata e
asciugata



11409



05702

Sabbie da gioco

11409

confezione 1 kg. sabbia speciale compatta
"effetto bagnato" + formine

05702

sabbia da gioco sacco kg.15



realizzata
con materiale
BIO

DISEGNI VARIABILI PER LA STAGIONALITÀ

08905 - palla mare ø cm.14 multicolor

09422 - palla mare ø cm.23 multicolor

612 Movimento e psicomotricità

Piramidi

Di dimensioni graduate e dai colori vivaci presentano numeri o disegni che aiutano i piccoli a imparare a contare o a riconoscere le dimensioni. Ideale per giocare in casa, in giardino e in spiaggia.



GW45333

GW45311

GW45333

piramide di numeri
impilabile cm.18x18x90 h
(11 pezzi)

GW45311

piramide GIGANTE
cm.18x18x90 h
(12 pezzi)



Giochi per esterno

Tunnel ideali sia per interni che per esterni per attività ludiche e psicomotorie. Prodotti in materiale acrilico resistente alla luce del sole e agli agenti atmosferici.

09226

treno tunnel
altezza massima: cm.106



07837

cavallino a dondolo (in plastica)
cm.84x28x46 - colori assortiti



07366

robusto dondolo "Coccodrillo" (in plastica)
lavabile, spigoli arrotondati. Dotato di 2 grandi maniglie,
3 posti a sedere e piedini antiribaltamento



Mezzi di trasporto giganti



65000

camion ribaltabile GIGANTE (in plastica)



CM.68,5x25x33



66000

trattore GIGANTE (in plastica)



CM.63,5x24x30



10950

carretto/carrello duplice funzione (in plastica)



CM.60x29,5x23



Realizzati in plastica di alta qualità, resistenti alle intemperie, questi giocattoli sono indicati anche all'esterno.

Mezzi di trasporto giganti

Realizzati in plastica di alta qualità, resistenti alle intemperie, questi giocattoli possono essere conservati per tutto l'anno anche all'esterno.



cm.43

32103

camion della spazzatura
(in plastica)



Il camion della spazzatura è dotato di un contenitore per la spazzatura completamente funzionale, grazie al quale il gioco sarà ancora più realistico.



cm.38

32121

camion con ribalta (in plastica)



Il camion ribaltabile ha un box di carico che può essere sollevato e abbassato rendendo il gioco ancora più realistico.



cm.44

32122

camion con gru (in plastica)



Il grande veicolo ha una gru scorrevole e molte parti mobili che renderanno più realistico il gioco.



cm.44

32124

camion betoniera (in plastica)



Un grande veicolo con molti elementi mobili che renderà più divertente il gioco. La betoniera viene ruotata per mezzo di una manovella montata sul lato sinistro della macchina.

Carriola e trattore



IMPILABILE

74800

carriola (in plastica)



CM.66x34x30

+2
ANNI

Ideale per giocare sulla spiaggia e in giardino,
Colori assortiti nell'imballo.



14059

carriola (in metallo)



CM.74x31x33,5

+3
ANNI



12270

carriola "Magùt" (in metallo)
vasca rossa e telaio giallo



CM.77x37x47

+3
ANNI

1,7
KG



12271

carriola "Magùt Pro" (in metallo)
vasca metallizzata e telaio rosso



CM.80x48x41

+3
ANNI

2
KG



14060

carretto trainabile (in metallo)



CM.101x25x21

+3
ANNI



14148

trattore (in metallo) con rimorchio



TOTALE CM.122

+3
ANNI



Tricicli e monopattini



2 in 1
quadriciclo
e girello

Un gioco multiuso: girello e quadriciclo! Massimo supporto e stabilità. I piccoli possono imparare a camminare in sicurezza. Utilizzabile sia all'interno che all'esterno.

● SI3000GR

"cammina e cavalca" (in plastica)



Ruote
silenziose



12267

triciclo "Start-Asilo"
(telaio in metallo)
ruote silenziose, fermo forcella
laterale - seduta cm.27
colore verde/arancio



12268

triciclo "Start-Materna"
(telaio in metallo)
ruote silenziose, fermo forcella
laterale - seduta cm.30
colore rosso/verde



BJ776

la mia prima bicicletta "Superbike" a spinta (in legno)
seduta da cm.37 a 41 - colore rosso



12266

bicicletta "Superbike"
a spinta (telaio in metallo)
seduta da cm.36 a 41
colore rosso



12265

monopattino "Go-Fast"
(telaio in metallo)
con ruote gonfiabili e freno
colore argento/rosso



Ruote
gonfiabili
1,5 bar



12269

triciclo "Premium-Cresco"
(telaio in metallo)
con ruote gonfiabili, timone, freno
seduta cm.23 - colore argento/rosso



Ruote
gonfiabili
1,5 bar





Arredo

La scuola è una seconda casa sia per i bambini che per gli insegnanti. Per questo motivo crediamo sia giusto arrearla al meglio, per renderla il più piacevole e funzionale possibile per chiunque vi trascorra tante ore ogni giorno.

In questa sezione troverete suggerimenti per arredare ogni area della scuola: dalla zona dell'ingresso/accoglienza agli spogliatoi, dalle aule ai laboratori.

629 Spogliatoi

635 Tavoli

641 Sedie

687 Protezione e sicurezza



Made in Italy

QUALITÀ CERTIFICATA

MILANO ARREDI presenta un'ampia e diversificata gamma di arredi in legno di altissima qualità e pregio, in grado di soddisfare anche le più moderne esigenze estetiche, cercando sempre di preservare le suggestioni che solo un materiale come il legno è in grado di evocare. Tutti gli elementi MILANO ARREDI sono stati progettati per l'utilizzo in aule, ambienti scolastici, asili, comunità. La sicurezza di questi arredi è garantita dall'utilizzo di materiali di alta qualità, atossici, stabili e resistenti, con spigoli arrotondati antitrauma. Ogni singolo elemento è realizzato rispettando le normative vigenti in materia di sicurezza, incluse le norme riguardanti la presenza di formaldeide.



QUALITÀ NEL DESIGN

La gamma di MILANO ARREDI si diversifica in due linee:



LINEA MILANO

- mobili realizzati in multistrato di betulla
- spessore mm.18
- ferramenta di alta qualità e resistenza
- spigoli arrotondati nel rispetto delle norme di sicurezza
- verniciature al naturale con materiali di alta qualità



LINEA SIMPLY

- mobili realizzati con legno conglomerato nobilitato
- spessore mm.20
- superficie antigraffio e antiriflesso ad alta resistenza
- spigoli arrotondati con raggio mm.3 e bordo ABS mm.3 nel rispetto delle norme di sicurezza
- rifiniture posteriori che consentono di utilizzare i mobili come divisori
- assemblaggio garantito da ferramenta di qualità



Milano®
arredi



Made in Italy

Elementi progettati per l'utilizzo in aule, ambienti scolastici, asili, comunità. La sicurezza di questi arredi è garantita dall'utilizzo di materiali di alta qualità, atossici, stabili e resistenti, con spigoli arrotondati antitrauma. Ogni singolo elemento è realizzato rispettando le normative vigenti in materia di sicurezza, incluse le rigidissime norme riguardanti la presenza di formaldeide.



Tutti i nostri arredi vengono consegnati smontati (salvo dove espressamente indicato) ma all'interno della confezione troverete facili istruzioni per un corretto assemblaggio.



Accoglienza



Nella foto: mensola art. 08441,
mobile art. 09515 della linea
Simply, fasciatoio art. 08436,
panca in legno art. 07790.



Fasciatoi

Una linea di mobili fasciatoio in legno multistrato di betulla per soddisfare le più svariate esigenze. Tutti i materiali utilizzati sono di ottima qualità. Le vernici utilizzate sono atossiche; gli angoli e gli spigoli sono arrotondati per assicurare l'incolumità di bambini ed educatori. Minimo ingombro. Dotati di ruote e di materassini soft.



08436

fasciatoio con ruote
tappetino in vinyl incluso



CM.56x75x90



08368

fasciatoio MAXI con ruote
tappetino in vinyl incluso



CM.140x75x90

Fasciatoio salvaspazio

Innovativo fasciatoio verticale da fissare alla parete. Indicato per gli ambienti in cui c'è carenza di spazio. Resistente ma leggerissimo: sicuro e facile da fissare, grazie al pistone laterale si apre con un semplice gesto della mano ed è molto capiente.

09968

fasciatoio cm.60x83 h (in legno)
nella confezione è incluso un morbido materassino

10203

fasciatoio cm.60x83 h (in legno) CON DISEGNO
nella confezione è incluso un morbido materassino



Mobili fasciatoio

Mobile fasciatoio in multistrato di betulla provvisto di due ripiani facilmente accessibili su cui riporre tutto il necessario per la toeletta dei piccoli da uno scomparto con antina in cui alloggiare il cestino per rifiuti. Disponibile anche nella versione con praticissima scaletta a scomparsa grazie alla quale i bambini potranno essere accompagnati sul fasciatoio.

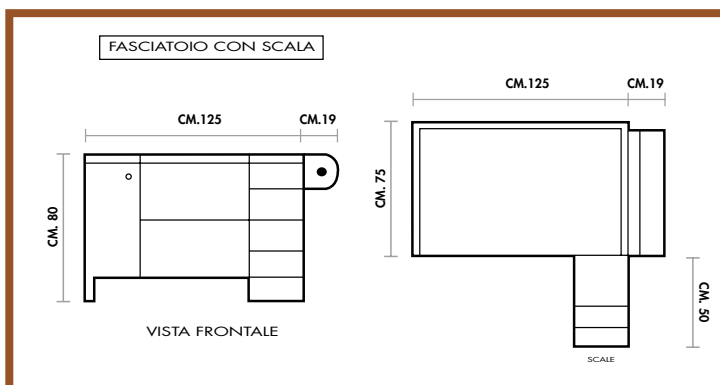

08191

fasciatoio senza scala
completo di materassino con sponde e rotolo
di lenzuolini monouso inclusi



CM.125x75x85



08192

fasciatoio con scala rientrante
completo di materassino con sponde e rotolo
di lenzuolini monouso inclusi



CM.125x75x85



08141

rotolo lenzuolo medico mt.80x60
cm. 2 veli (216 strappi)

● **08369**

struttura portarotolo/lenzuolo in legno
(lenzuolo escluso). Applicabile ai
fasciatoi (art. 08436 e 08368)



Accessori per fasciatoi



TAPPETO SOFT

08438

in gomma cm.52x72x0,5 h
(per fasciatoio art. 08436)

08193

cm.70x120x0,5 h
(per fasciatoio art. 08191 e 08192)



MATERASSINO

● **08443**

in gomma cm.52x72x4 h
(per fasciatoio art. 08436)

● **08372**

in gomma cm.73x136x4 h
(per fasciatoio art. 08368)

● **08194**

morbido cm.70x120x8 h
(per fasciatoio art. 08191 e 08192)

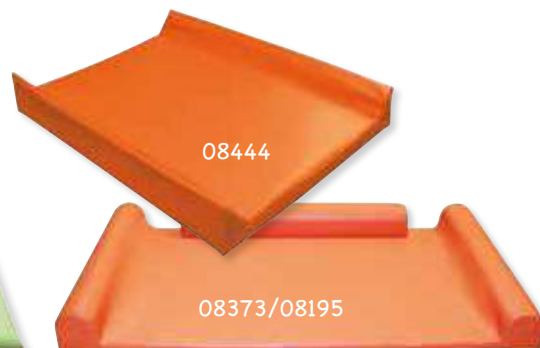

MATERASSINO CON SPONDE

● **08444**

cm.71,5x52,5x3/9 h
(per fasciatoio art. 08436)

08373

cm.73x136x12 h (nel punto più alto)
(per fasciatoio art. 08368)

08195

cm.70x120x12 h (nel punto più alto)
(per fasciatoio art. 08191 e 08192)

Contrassegni

Serie di allegri contrassegni in tela e in plastica autoadesiva, con motivi chiari, semplici e ben riconoscibili. Ogni bambino ha un contrassegno personale per individuare facilmente il proprio armadietto, grembiule, brandina, quaderno, ecc... Il set include 36 soggetti diversi, ognuno dei quali è presente sia in versione autoadesiva (3 pezzi), sia in stoffa (1 pezzo), da cucire sul grembiolino o sulla salviettina.



05447

set 144 contrassegni
Con una confezione si hanno contrassegni diversi per 36 bambini: ogni bambino avrà il proprio soggetto su 3 adesivi in plastica e 1 in stoffa.

Contrassegni - portafoto

Portafoto in materiale plastico trasparente. Ideale per contrassegnare gli oggetti dei bambini: brandina, armadietto dello spogliatoio, appendiabiti eccetera; in questo modo il bambino riconoscerà le sue cose grazie alla fotografia, magari abbinata al suo nome.



08769x10

10 portafoto in plastica rigida
(con due fori per fissaggio)



CM.7x8,5



08771x10

10 portafoto in plastica rigida



CM.6x4



08770x10

10 portafoto in plastica rigida
retro adesivo



CM.6x6



08772

in plastica morbida
retro adesivo - busta 20 pezzi



CM.7x3

Bagnetto fasciatoio



09566

mobiletto "ARIEL"

cm.47x95x100 h - Peso kg.20

Bagnetto fasciatoio in plastica antiurto, dotato di 4 ampi cassetti. Portaoggetti asportabile con portasalvietta. Antimuffa e interamente lavabile. Può stare anche all'esterno. Fasciatoio in PVC senza ftalati.



09568

bagnetto pieghevole

cm.63x75x90 h - 5 kg

Leggera ma stabile struttura in acciaio. Vaschetta anatomica ambidestra con tubo per lo scarico dell'acqua. Sistema di bloccaggio e antischiacciamento.

Contenitore sigilla pannolini

Studiato per rendere più facile il momento del cambio, utilizza un sistema di sigillatura unico e brevettato che avvolge individualmente i pannolini in una pellicola profumata.

Caratteristiche:

- Protezione garantita contro i cattivi odori: i pannolini sono avvolti singolarmente così da non far fuoriuscire odori sgradevoli, 100 volte più efficace dei tradizionali sacchetti per pannolini;
- Protezione garantita contro i germi: al contatto la pellicola multistrato antibatterica uccide il 99% di tutti i germi pericolosi
- Ancora più ecologico: il mangiapannolini e la struttura della ricarica sono al 98% in plastica riciclata e completamente riciclabile;
- contiene fino a 60 pannolini alla volta (stima su pannolini da neonato);



12944

ricarica per contenitore sigilla pannolini

09573

contenitore MAXI sigilla pannolini
cm.26,3x29,8x77,5



Fasciatoio/materassino



09549

fasciatoio/materassino da tavolo
cm.49x80x9 h alla sponda



11327

cm.120x70 (cm.50 interno) x cm.5 h
(cm.15 altezza sponda) colore blu



09263

fasciatoio/materassino da tavolo cm.58x74x3 h

Appendiabiti

Appendiabiti in legno multistrato di betulla, da fissare alle pareti. Indispensabili in ogni asilo nido, scuola materna o elementare per appendere cappotti, salviette, grembiulini...



11513

appendiabiti (in legno) con portafoto - 8 posti



09543

appendiabiti/grembiulini (12 posti)



09417

appendiabiti/grembiulini (12 posti) + banda portafoto



08715

appendiabiti (in legno) con banda portafoto (5 posti)

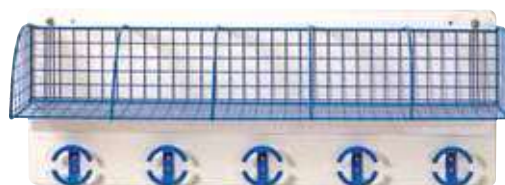

08790

appendiabiti (in legno) con portafoto e mensola portatutto in acciaio verniciato (5 posti)



07859

appendiabiti in legno e materiale acrilico (5 posti)



07860

appendiabiti in legno e materiale acrilico (5 posti) con mensola



09915

appendiabiti per grembiuli in legno e materiale acrilico (15 posti)



Appendiabiti

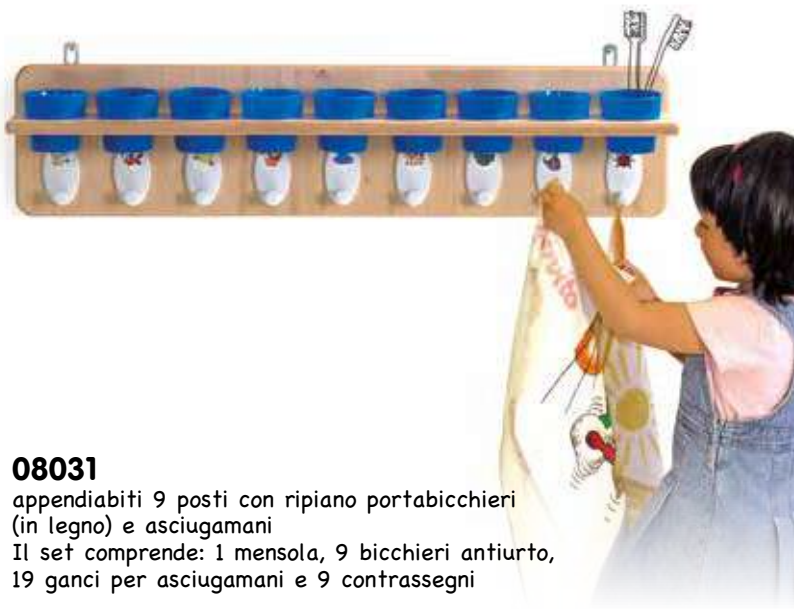

08031

appendiabiti 9 posti con ripiano portabicchieri (in legno) e asciugamani
Il set comprende: 1 mensola, 9 bicchieri antiurto, 19 ganci per asciugamani e 9 contrassegni



CM.94x18



CM.100x25

09911

appendiabiti in agglomerato ligneo "Trenino degli animali" (8 posti)



10237

pannello appendiabiti NUVOLA cm.90x80
mensola profondità cm.19
completa di tre specchi sicurezza

Albero delle presenze



10235

albero (in legno) cm.83x122 h + dischetti portafoto



10236

albero appendiabiti in legno



CM.122x83

Mensola



08644

mensola "Jolly" in tondino d'acciaio verniciato



CM.20x100x17



08062

coppia reggimensole argento



CM.9,6x11,8

● **08063**

coppia reggimensole argento



CM.11x15

08064

coppia reggimensole argento



CM.14x20



Ripiani multiuso

Ripiani realizzati con pannello truciolare nobilitato di alta qualità.

09541

ripiani portasalviette-pannolini in legno (16 vani)



CM.56x106x27,5



● **08060**

coppia reggimensola "Teddy" blu



CM.17x3x20



● **08061**

coppia reggimensola "Kitty" giallo



CM.14x3x21

Mensole

Mensole in solido legno multistrato di betulla da mm.18. Levigate, senza trattamenti, pronte per essere verniciate.

08084 - cm.60x10

08085 - cm.60x15

08086 - cm.60x20

08087 - cm.80x15



08441

mensola (in legno) con separatori e reggimensole fantasy (in metallo)



CM.140x22



09926

mensola/appendiabiti (in legno) con separatori e reggimensole fantasy (in metallo) dotata di 7 appendiabiti



CM.140x22

Asta per misurazioni



R67675



09924

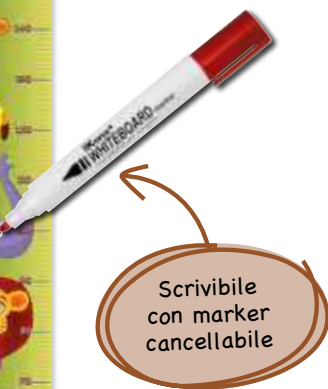

Scrivibile con marker cancellabile

Appendiabiti con portaombrelli

cm.178 h

10358

appendiabiti \varnothing cm.32x178 in metallo verniciato e plastica, testa girevole, ganci di appoggio + portaombrelli a 4 fori



Spogliatoi



Nelle foto: isola/mobile
spogliatoio doppio art. 08722;
sullo sfondo: mobile
art. 09523 (3 ante),
art. 09520 (2 ante)
della linea Simply.

Spogliatoi

Spogliatoi in legno multistrato di betulla, molto resistenti e a misura di bambino: angoli e bordi sono smussati e le viti restano fuori dalla portata dei bambini. Nel vano sotto la seduta può essere inserita la mensola "Jolly" ideale per riporre zainetti e scarpine.

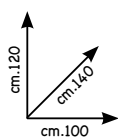

08701

mobile spogliatoio (5 posti) in legno con cappelliera, appendiabiti e fascia portafoto



08644

mensola "Jolly" in tondino d'acciaio verniciato (5 posti) Per riporre zainetti, scarpe, ecc...

08703

tavolino/panca in legno

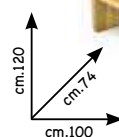
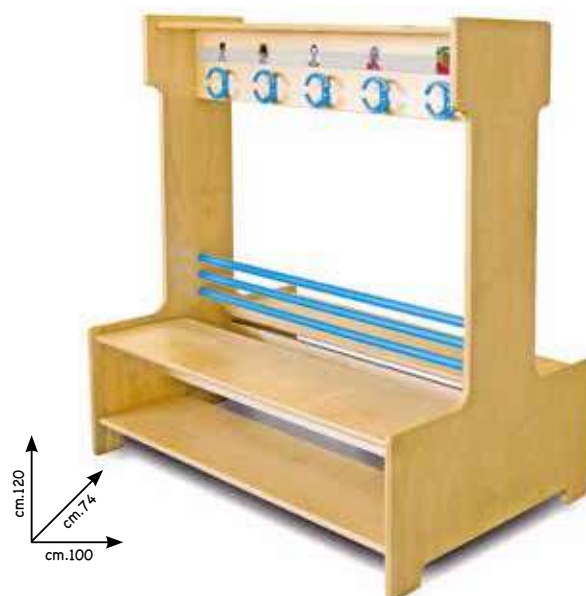
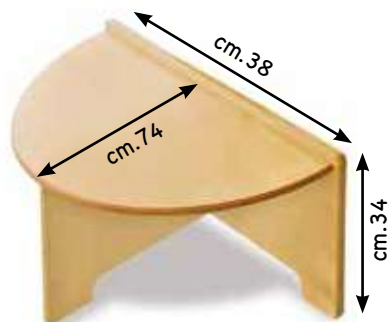

08679

mobile spogliatoio **BIFACCIALE** (10 posti) in legno completo di appendiabiti e fascia portafoto



SPOGLIATOIO BIFACCIALE + TAVOLINO/PANCA



2 SPOGLIATOI BIFACCIALI + TAVOLINO/PANCA



Spogliatoi

Armadietti/spogliatoi in legno multistrato di betulla, molto resistenti e capienti, a misura di bambino: angoli e bordi sono smussati, le viti restano fuori dalla portata dei bambini. All'interno di ogni armadietto sono presenti un appendiabiti per ciascuna ante. Lo spogliatoio è disponibile anche nella versione con ante, dotate di apertura facilmente impugnabile e apribile dai bambini.

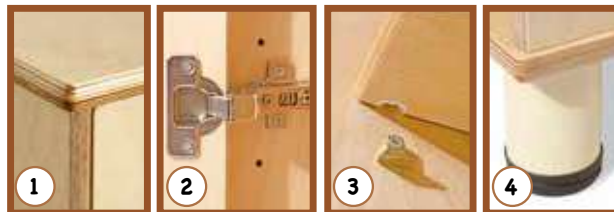

1 - Angoli arrotondati; 2 - Cerniera in acciaio; 3 - Spalle laterali predisposte per inserire ripiani; 4 - Piedini rialzati antiscivolo



07857

spogliatoio in legno a giorno (6 posti)



CM.106x45x100



07858

spogliatoio in legno a 3 ante (6 posti)



CM.106x45x100

Spogliatoi in legno conglomerato nobilitato con ripiano in formica atossica. Spigoli arrotondati, piano antigraffio.



09853

09518

spogliatoio a giorno in legno (6 posti)

09853

spogliatoio a giorno in legno (6 posti) con 3 divisori



CM.106x45x100



1 - Spigoli arrotondati

2 - Piedini in metallo

Scarpiera



Accessibile da entrambi i lati. La scarpiera è dotata di pratiche rastrelliere in metallo facilmente lavabili.

20
PAIA DI
SCARPE

09149

scarpiera (in legno)



CM.44x42x102

Spogliatoi

Spogliatoi in legno conglomerato nobilitato con ripiano in formica atossica. Spigoli arrotondati, piano antigraffio.

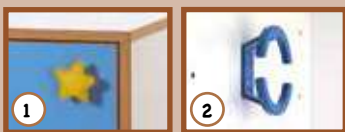

- 1 - Maniglie in gomma antitrauma
- 2 - Appendiabiti



**Spogliatoio cm.70x45x100h
CON 2 ANTE (4 POSTI)**

- 09519 Magnolia
- 09520 Azzurro
- 09521 Verde

**Spogliatoio cm.70x45x100h
CON 2 ANTE (4 POSTI)**

- 09847 Magnolia
- 09848 Azzurro
- 09849 Verde

CON DIVISORIO



DIVISORIO:

Divisorio in materiale plastico antiseptico completamente lavabile. Facilmente estraibile per una pratica pulizia e disinfezione dello spogliatoio, come previsto dalle più recenti normative igienico-sanitarie riguardanti gli ambienti pubblici e gli spazi condivisi.



**Spogliatoio cm.106x45x100h
CON 3 ANTE (6 POSTI)**

- 09522 Magnolia
- 09523 Azzurro
- 09524 Verde

**Spogliatoio cm.106x45x100h
CON 3 ANTE (6 POSTI)**

- 09850 Magnolia
- 09851 Azzurro
- 09852 Verde

CON DIVISORIO

**Spogliatoio cm.106x45x100h
CON 4 ANTE (4 POSTI)**

- 10511 2 ante verdi
2 ante azzurre

Spogliatoio modulare "Brio"

pag.623
contrassegni
e portafoto

Armadio guardaroba per i vestiti e le scarpe dei bambini. Funzionale grazie ai fori sagomati appositamente progettati per l'apertura che assicurano il flusso d'aria. Indicato per arredare gli spogliatoi.



● 12120

spogliatoio in legno "BRIO"
(8 armadietti con ante colorate, ripiani e ganci)



CM.130x35x172

Spogliatoio



● 10385

spogliatoio in legno (5 posti)



CM.113,5x44,5x130

● 10386

spogliatoio in legno (3 posti)



CM.69x44,5x130



Aula pranzo



Nella foto: tavolo esagonale materna art. 07805, tavolo rotondo materna art. 07801, tavolo semicircolare materna "pappa" art. 07807. Sedie in legno art. 07938 e 07939. Sullo sfondo composizione di mobili a giorno della linea Milano art. 07809, 07808, 07891, 08448. Carrello base in legno art. 08103.

Tavoli

Robusti tavolini in plastica, igienici e facili da lavare, ideali per uso massiccio. Sedie non incluse.

ADATTI ANCHE
PER AMBIENTI
ESTERNI



09223

tavolo tondo 8 posti
(nido) ø cm.116x48 h

NOVITA'

09223/53

tavolo tondo 8 posti
(materna) ø cm.116x53 h



09224

tavolo rettangolare 6 posti
(nido) cm.125x65x48 h

NOVITA'

09224/53

tavolo rettangolare 6 posti
(materna) cm.125x65x53 h



● **09222**

tavolo semicircolare pappa
(in plastica) cm.165x90x48 h



09225

tavolo quadrato 4 posti
(nido) cm.62x62x48 h

NOVITA'

09225/53

tavolo quadrato 4 posti
(materna) cm.62x62x53 h

Tavolo telescopico





PER INTERNI

46/58

**DOPPIA
ALTEZZA**

Tavolo telescopico (in legno)
cm.120x60x46/58 h

monocolore

- | | | |
|--------------|---|--------|
| 10870 |  | Rosso |
| 10871 |  | Giallo |
| 10872 |  | Blu |
| 10873 |  | Verde |



pag.642
sedia regolabile

Tavoli con gambe in legno

Tavoli in multistrato di betulla: sicuri, igienici e ideali soprattutto per utilizzi frequenti, disponibili in vari formati che si adeguano all'altezza dei bambini. L'assortimento di forme e dimensioni consente di selezionare il tavolo più adatto alle proprie esigenze (pappa, gioco, manipolazione, studio...) e agli spazi disponibili. Tutta la betulla utilizzata è classificata E1 - priva di formaldeide. Gambe in legno e colore del ripiano naturale.



Made in Italy



- Piedini regolabili
- Attacchi resistenti e di qualità
- Spigoli arrotondati

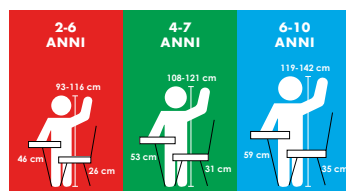

07800

tavolo tondo (in legno)
 ø cm.100x46 h - **nido**

07801

tavolo tondo (in legno)
 ø cm.100x53 h - **materna**

10314

tavolo NIDO (in legno)
 ø cm.100x20
 (per giocare seduti a terra)



07794

tavolo quadrato (in legno)
 cm.65x65x46 h - **nido**

07795

tavolo quadrato (in legno)
 cm.65x65x53 h - **materna**



● **07802**

tavolo tondo (in legno)
 ø cm.100x46 h - **nido**
 con vasca ø cm.40

● **07803**

tavolo tondo (in legno)
 ø cm.100x53 h - **materna**
 con vasca ø cm.40



10361

tavolo rettangolare grande (in legno)
 cm.150x75x46 h - **nido**

10362

tavolo rettangolare grande (in legno)
 cm.150x75x53 h - **materna**

10363

tavolo rettangolare grande (in legno)
 cm.150x75x58 h - **elementare**

10364

tavolo rettangolare grande (in legno)
 cm.150x75x76 h - **adulti**

07796

tavolo rettangolare (in legno)
 cm.130x65x46 h - **nido**

07797

tavolo rettangolare (in legno)
 cm.130x65x53 h - **materna**

Tavoli con gambe in legno



● **07798**

tavolo semicircolare (in legno)
cm.130x65x46 h - **nido**

● **07799**

tavolo semicircolare (in legno)
cm.130x65x53 h - **materna**



● **07868**

tavolo trapezoidale (in legno)
cm.130x57x46 h - **nido**

● **07869**

tavolo trapezoidale (in legno)
cm.130x57x53 h - **materna**



07806

tavolo semicircolare (in legno)
cm.150x90x46 h - **nido**

07807

tavolo semicircolare (in legno)
cm.150x90x53 h - **materna**



07804

tavolo esagonale (in legno)
ø cm.130x46 h - **nido**

07805

tavolo esagonale (in legno)
ø cm.130x53 h - **materna**

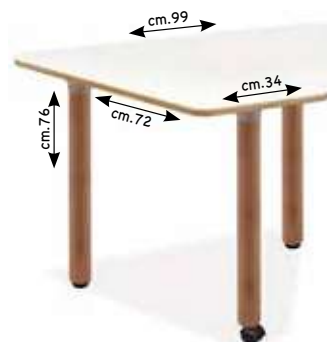

● **11597**

tavolo con tre gambe
(in legno) cm.99x72x34x76 h

Tavolo ribaltabile a scomparsa

Tavolo ribaltabile a scomparsa in multistrato di betulla. Si presta a diversi utilizzi; non ancorare a pareti in cartongesso o altre superfici forate. Si consiglia di verificare periodicamente la tenuta degli elementi di fissaggio.

11367

tavolo ribaltabile a scomparsa
cm.75x137x46 h - **nido**

11368

tavolo ribaltabile a scomparsa
cm.75x137x53 h - **materna**

11369

tavolo ribaltabile a scomparsa
cm.75x137x76 h - **adulti**

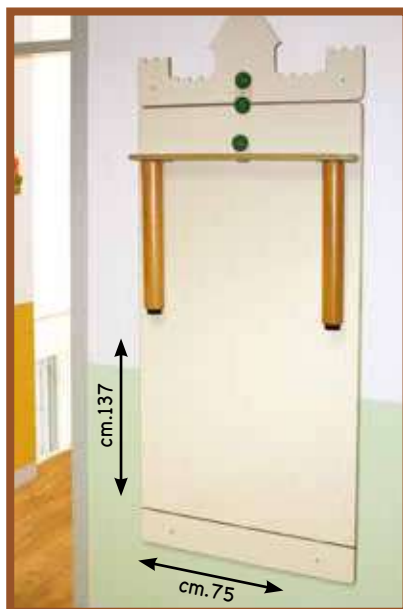

Tavoli con gambe in metallo

Tavoli in legno conglomerato nobilitato con ripiano in formica atossica. Hanno robuste **gambe in tubolare d'acciaio** che ne garantiscono la perfetta stabilità e solidità. Spigoli arrotondati, piano antigraffio. Ogni tavolo è dotato di piedini regolabili grazie ai quali è possibile sistemare la stabilità del tavolo e modificarne leggermente l'altezza.



Made in Italy



08076

tavolo quadrato (in legno)
cm.65x65x46 h - **nido**

08077

tavolo quadrato (in legno)
cm.65x65x53 h - **materna**

08078

tavolo quadrato (in legno)
cm.65x65x64 h - **elementare**

08079

tavolo quadrato (in legno)
cm.65x65x75 h - **adulti**



08072

tavolo rettangolare (in legno)
cm.130x65x46 h - **nido**

08073

tavolo rettangolare (in legno)
cm.130x65x53 h - **materna**

08074

tavolo rettangolare (in legno)
cm.130x65x64 h - **elementare**

08075

tavolo rettangolare (in legno)
cm.130x65x75 h - **adulti**



08080

tavolo tondo (in legno)
ø cm.100x46 h - **nido**

08081

tavolo tondo (in legno)
ø cm.100x53 h - **materna**



09145

tavolo semicircolare (in legno)
cm.150x84,5x46 h - **nido**

09146

tavolo semicircolare (in legno)
cm.150x84,5x53 h - **materna**



08070

tavolo esagonale (in legno)
ø cm.130x46 h - **nido**

08071

tavolo esagonale (in legno)
ø cm.130x53 h - **materna**

Tavolini



07815

tavolo quadrato (in legno)
cm.50x50x43



07816

tavolo tondo (in legno)
ø cm.60x43



Sedie



SEDIA
seduta: cm.16

10855

sedia multiuso (in MDF)
LINEA SIMPLY

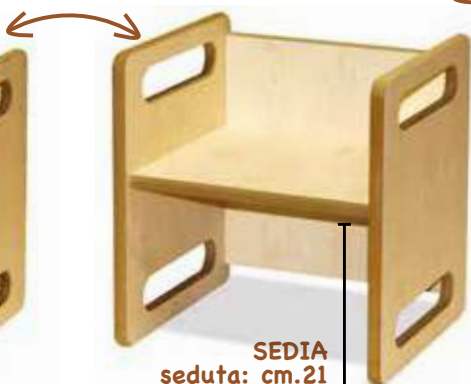

SEDIA
seduta: cm.21

10854

sedia multiuso (in multistrato di betulla)
LINEA MILANO

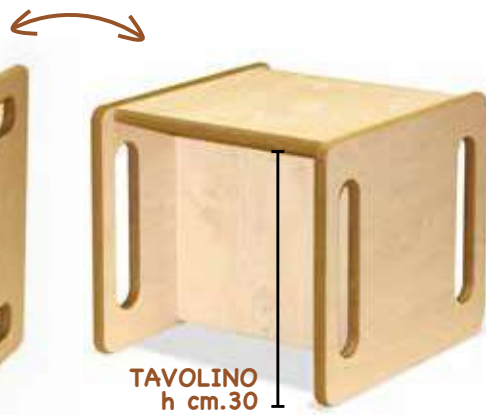

TAVOLINO
h cm.30



07791

sedia (in legno verniciato)
cm.38x29x43 h
seduta: cm.22



09804

sedia (in legno) cm.27x37x47 h
seduta cm.21

09805

sedia (in legno) cm.27x37x53 h
seduta cm.26



Sedia cubo

Seduta in gomma colorata
antiscivolo, rimovibile e lavabile.

07817

sedia cubo (in legno verniciato)
cm.25x25x25 h

Panche

Panche in legno naturale pratiche, resistenti e sicure, possiedono una caratteristica unica: senza utilizzare viti o altri attrezzi, a seconda delle esigenze e dell'altezza dei bambini di asili nido e scuole materne, è possibile cambiare l'altezza della seduta e trasformarla in un pratico tavolino. A misura di bimbo! Per adattare le panche all'altezza dei bambini o trasformarle in tavolino sarà sufficiente capovolgerle.



Made in Italy



07813

panca multiuso (in legno) cm.100x30x35 - altezza sedute: cm.16 e 21

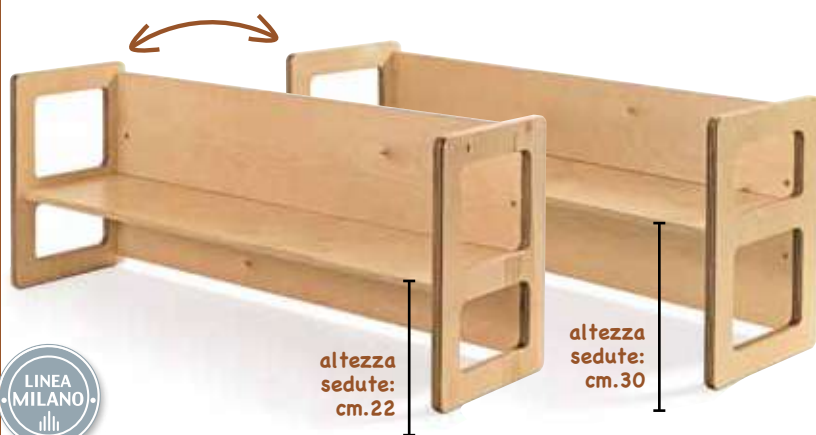

07790

panca multiuso (in legno) cm.125x32x52 h
altezza sedute: cm.22 e 30



07767

mobile (in legno) + cassettone
cm.80x40x40 h + 4 ruote

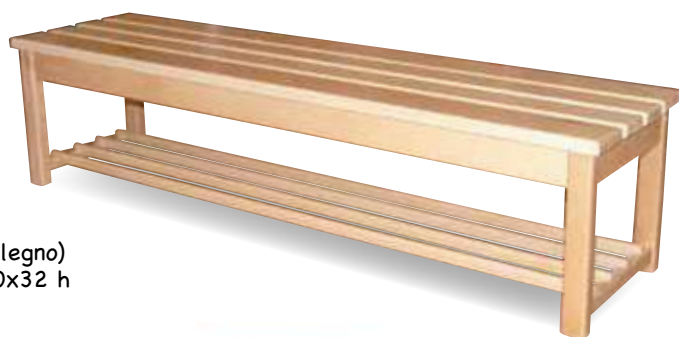

10255

panca (in legno)
cm.122x30x32 h



08115

panca (in legno) cm.36x92,5x42 h
+ 3 scomparti



09420

mobile panca (in legno) cm.109x46x43 h
con 2 ante e ruote + 4 cassette incluse

10357

materassino per mobile panca
cm.105x43x7 h (per art. 09420)

Sedia Piuma

La sedia per bambini più leggera di tutte: **SOLO 1 Kg!!**
La sedia PIUMA è resistentissima e adatta per un uso massiccio grazie alle gambe in alluminio diametro mm. 25.
La seduta è anatomica e favorisce la corretta postura del bambino. Facilmente lavabile. Ideale anche per esterni.

09384

12 sedie PIUMA cm.31 h **OFFERTA SPECIALE**
(specificare il colore desiderato)

ALTEZZA
SEDUTA
CM.31

- 09386/01**  Rosso
- 09386/02**  Giallo
- 09386/03**  Verde
- 09386/04**  Blu

09784

12 sedie PIUMA cm.35 h **OFFERTA SPECIALE**
(specificare il colore desiderato)

ALTEZZA
SEDUTA
CM.35

Sedie PIUMA cm.35 h

- 09387/01**  Rosso
- 09387/02**  Giallo
- 09387/03**  Verde
- 09387/04**  Blu



Ideali anche per esterni.



09840

sedia (in plastica)
cm.42x47x47 h - seduta: cm.27

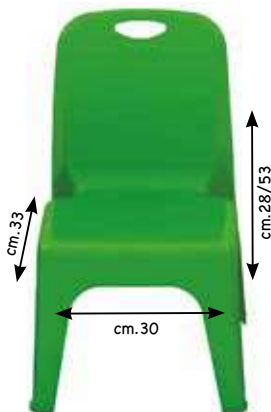

10874

sedia cm.30x33x28/53 h
colore verde



07086

sedia cm.26x27 h - seduta: cm.25

Sedie in materiale acrilico e metallo.

sedia: cm.30x62 h
altezza seduta: cm.34

Sedie in plastica e metallo

monocolore

-  **08121** Rosso
-  **08122** Giallo
-  **08123** Verde

ALTEZZA
SEDUTA
CM.34







Sedie

Coloratissime e resistenti, in materiale acrilico. Maneggevoli e facilmente lavabili. Ideali anche per esterni.



Sedie in plastica





monocolore

- 07828**  Rosso
- 07829**  Giallo
- 07830**  Verde
- 07831**  Blu

ALTEZZA
SEDUTA
CM.26

Sedie in plastica

monocolore

- 07832**  Rosso
- 07833**  Giallo
- 07834**  Verde
- 07835**  Blu

ALTEZZA
SEDUTA
CM.30







Sedia regolabile

Ideali anche per esterni. Vendita MONTATA

Sedia in plastica cm.44x39x58 h

monocolore

Minimo acquistabile: 5 pezzi per colore

- 10866**  Rosso
- 10867**  Giallo
- 10868**  Blu
- 10869**  Verde



DOPPIA
ALTEZZA

ALTEZZA
SEDUTA
CM.26

SOLO CON
PIEDINO
VERDE

ALTEZZA
SEDUTA
CM.30

CON PIEDINO
NERO
+ PIEDINO
VERDE

Sedie

Sedia molto leggera e robusta, realizzata in materiale acrilico ad alta resistenza. Si può pulire con qualsiasi detergente



Made in Italy



Sedie in plastica cm.33x33x53 h

ALTEZZA
SEDUTA
CM.30

monocolore

Minimo acquistabile: 4 pezzi per colore

12056  Azzurro

12057  Arancio

12058  Verde



- Impilabile fino a 12 sedie
- Seduta comoda ed ergonomica
- Colori atossici
- Facile da montare, vendita smontata (viti incluse)

Sdraietta - seggiolina

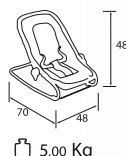

09556

sdraietta cm.48x70x48 h - 5 kg.

Seggiolina con ampie e morbide imbottiture. Struttura in acciaio con piedini stabilizzatori a scomparsa. Tessuto completamente sfoderabile e lavabile. Poggiapiedi musicale.

Passeggino "Linus"

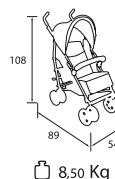

09555

passeggino cm.54x89x108 h - 8,50 kg.

Cinque posizioni, confortevole e affidabile. Doppio blocco di sicurezza e maniglie bicolore antiscivolo. Regolazione dello schienale a cinque posizioni e poggiambracci regolabile. Poggiatesta morbido e traspirante. Cinture di sicurezza regolabili a cinque punti. Ruote anteriori piroettanti, ammortizzate con blocco, e ruote posteriori ammortizzate con freno a pedale ON-OFF. Barra di sicurezza frontale. Cappottina parasole con finestrella di controllo. Parapioggia integrale e avvolgente coprigambe. Cesto portaoggetti in rete. Provvisto di comoda maniglia per il trasporto.

Girello "Imola"



● 09560

girello cm.66x60x58 h - 5 kg.

con seduta imbottita lavabile. Altezza regolabile a più livelli e bloccaggio antichiusura. Consolle con giochi sonori asportabile, certificata CE. Ruote piroettanti.

Seggiolone



7,00 Kg

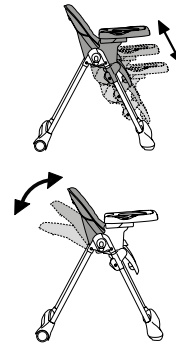

altezza
e schienale
regolabili



09557

seggiolone lusso cm.87x58x100 h - 7 kg.
Comodo, con schienale e seduta abbondantemente imbottiti. Altezza e schienale regolabili in molteplici posizioni. Cinture di sicurezza regolabili a cinque punti. Crotch-bar di protezione anticaduta. Secondo davanzalino asportabile, da usare anche come vassoio. Piedini anteriori antiscivolo. Ruote posteriori per spostarlo più facilmente. Di minimo ingombro quando chiuso.



Seggiolone in faggio tornito

10360

seggiolone in legno cm.47x49x62,5 h (schienale)
seduta: cm.37,5x26 (profondità) x30 h (seduta), completo di materassino imbottito in tessuto spalmato plastico lavabile. Si consiglia di utilizzarlo con i tavoli di cm.52,5 h

11943

materassino imbottito in tessuto spalmato plastico lavabile (ricambio per seggiolone art.10360)

Seggiolino da tavolo "pappa"



2,00 Kg

09559

seggiolino da tavolo "Pappa"
cm.40x42x34 h - 2 kg.
Colori assortiti soggetti a disponibilità. Realizzato in tessuto interamente sfoderabile e lavabile. Cinture di sicurezza. Pratica tasca portaoggetti. Adattabile a qualsiasi tavolo grazie alla versatilità del morsetto.



Cesta/box - portatutto

Pratici box in materiale acrilico coprente per fare ordine e riporre giocattoli, costruzioni, libri, attrezzi ginnici... Dotati di comode ruote che ne facilitano lo spostamento. Molto indicati per scuole, asili, palestre, laboratori ricreativi ma anche per la cameretta dei bimbi.

05511

cesta con coperchio (in plastica)
cm.60x80x19 h - capacità lt.65

05507

box con ruote (in plastica)
cm.40x60x37 h - capacità lt.60



05508

box con ruote (in plastica) cm.45x80x54 h
capacità lt.110

08840

contenitore (in plastica)
cm.97x54x57 h - lt.240

Contenitore provvisto di ruote e predisposto per la chiusura con lucchetto (non incluso). Facile da trasportare grazie alle pratiche impugnature laterali.



09987

cesta morbida (in plastica)
Ø cm.30x24 h - capacità lt.13

09988

cesta morbida (in plastica)
Ø cm.40x30 h - capacità lt.32



05510

cesta pieghevole (in plastica)
cm.48x35x24 h - capacità lt.36

* I colori possono variare in base alla disponibilità di magazzino.

Mobili modulari "Brio"

Mobili in legno indicati per arredare aule gioco e zone spogliatoio. Funzionali e convenienti, questi mobili sono facilmente raggiungibili da tutti i bambini. Le ante sono nei colori dell'arcobaleno e la combinazione dei colori aiuta il bambino a trovare il proprio scomparto.

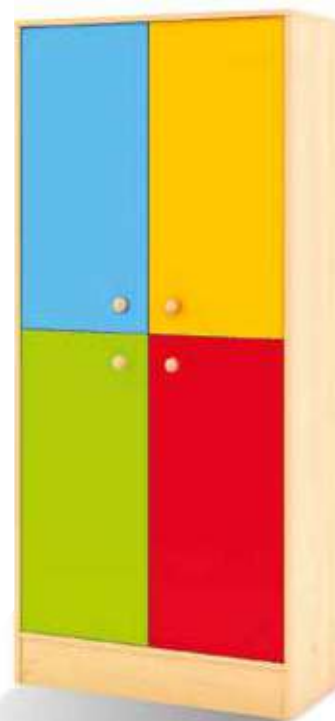
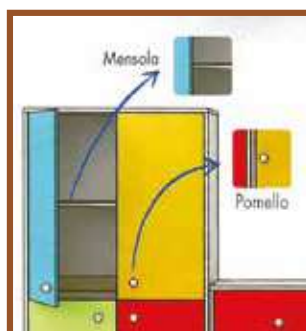

12118

mobile (in legno) "BRIO OPEN"
(2 ripiani)



CM.99x35x81

10392

mobile (in legno) "BRIO"
(6 armadietti con ante colorate)



CM.99x35x81

12119

mobile (in legno) "BRIO"
(4 armadietti con ante colorate)



CM.86x35x192



Mobili modulari "Brio"



12117

mobile (in legno) "BRIO OPEN"
(3 ripiani)



CM.99x35x112



12115

mobile (in legno) "BRIO"
(9 armadietti con ante colorate)



CM.99x35x112



12116

mobile (in legno) "BRIO"
(3 armadietti con ante colorate
e 3 cassetti colorati)



CM.99x35x112



pag.623
contrassegni e portafoto

Mobili componibili

Mobile a giorno componibile con facilità sovrapponendo e posizionando a piacere i singoli elementi a parallelepipedo. Creare un mobile ad hoc in base alle proprie esigenze non è mai stato così semplice! Tutti i componenti sono realizzati in resistentissimo legno multistrato di betulla di prima qualità, con angoli e bordi smussati per garantire la sicurezza dei bambini.



07766

mobile (in legno) "CUBO"
verde cm.40x40x30
fondo colorato

La foto rappresenta solo un esempio di composizione realizzabile con i parallelepipedo, i cassettoni e i ripiani separatori.

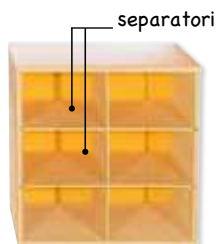

07847

3 separatori (in legno)
per creare 6 vani
(ogni vano misura cm.12x18)

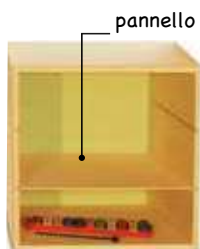

07846

pannello (in legno) cm.38x28



07848

cassettone con ruote cm.80x30x40 h



07767

mobile con cassettone cm.80x40x40 h

Mobili

Milano Arredi propone una vasta gamma di elementi d'arredo, di ogni forma e dimensione, abbinabili a seconda dello spazio a disposizione e delle esigenze. I mobili a giorno della linea **Milano Arredi**, dal design moderno e originale, sono fabbricati in legno multistrato di betulla a prova di bambino con bordature e spigoli arrotondati.



RIPIANO IN LEGNO DI BETULLA

● **09943**

cm.106x43x1,8 spessore

coperchio rimovibile



07867

mobile angolare cm.45x45x100 h
con ripiani regolabili in altezza
e coperchio



07809

mobile angolare cm.45x45x100 h
con ripiani regolabili in altezza



● **07892**
mobile cm.72x45x100 h
(8 vani)



● **07865**
mobile cm.106x45x100 h
(12 vani)



● **07866**
mobile cm.106x45x100 h
(21 vani)



● **07864**
mobile cm.106x45x100 h (3 vani)

Mobili in legno multistrato di betulla. Tutte le versioni sono state appositamente ideate per essere riempite utilizzando le capienti cassette contenitore (art.07720 e seguenti) che grazie alle guide scorreranno con facilità proprio come i normali cassetti.



● **07891**
mobile cm.72x45x100 h
con 2 ante, 8 vani,
(4 cassette in cartone in omaggio)



● **07843**
mobile cm.106x45x100 h
con 3 ante, 12 vani,
(9 cassette in cartone in omaggio)



● **07842**
cassettiera cm.106x45x100 h
cassettiera 2 ante, 12 vani



● **07810**
cassettiera cm.38x45x100 h
(cassette escluse)



● **07811**
cassettiera cm.72x45x100 h
(cassette escluse)



● **07844**
cassettiera cm.72x45x100 h
cassettiera 1 ante, 5 vani
+ 7 cassette in plastica*
e guide incluse



● **07905**
confezione 4 ruote per mobili

● **09629**
cassettiera cm.72x45x100 h
+ 14 cassette in plastica
e guide incluse

Mobili



PER FOGLI
CM.50X70

07971

mobile (in legno) cm.73x109x96 h
con ruote e 10 ripiani (ogni ripiano
contiene fino a 300 fogli)
(Mobile fornito già assemblato)



07789

mobile (in legno) cm.78x45x100 h
10 ripiani (ogni ripiano contiene
fino a 300 fogli cm.50x70)
(Mobile fornito già assemblato)



10349

mobile linea PITTURA (in legno)
cm.93x45x78 h griglia asciugadisegni
e 7 cassette incluse



10350

mobile linea GIOCO (in legno)
cm.93x45x78 h
2 vani e 7 cassette incluse



10356

mobile (in legno) cm.106x45x100 h
con 3 vani + 10 cassette in plastica
e guide incluse

Mobili

Mobili in legno conglomerato nobilitato con ripiano in formica atossica.
Spigoli arrotondati, piano antigraffio. Tutti i mobili **SIMPLY** sono predisposti per l'applicazione delle ruote (art. 07905).

07905

confezione 4 ruote
per mobili



09499

mobile cm.38x45x100 h
+ 10 cassette SMILE



09500

mobile cm.72x45x100 h
+ 20 cassette SMILE



09501

mobile cm.106x45x100 h
+ 30 cassette SMILE



09505

mobile con 3 vani cm.106x45x100 h
+ 20 cassette SMILE

650 Arredo

Mobili

Mobili in legno conglomerato nobilitato con ripiano in formica atossica. Spigoli arrotondati, piano antigraffio.

LINEA
SIMPLY

- **09944**
cm.32,5x43x1,8 h
- **09945**
cm.72x43x1,8 h
- **09946**
cm.106x43x1,8 h



RIPIANO IN FORMICA



- **09528** mobile angolare
cm.40x40x100 h



- 09513**
mobile cm.106x45x100 h



- 09525**
mobile (8 vani)
cm.72x45x100 h



- 09526**
mobile (12 vani)
cm.106x45x100 h

Mobili

Mobili in legno conglomerato nobilitato con ripiano in formica atossica. Spigoli arrotondati, piano antigraffio. Tutti i mobili **SIMPLY** sono predisposti per l'applicazione delle ruote (art. 07905).

MOBILE cm.106x45x100 h - CON 2 ANTE E 3 VANI

10342 Magnolia

cm.100



LINEA
SIMPLY



MOBILE cm.72x45x100 h
CON 2 ANTE E 3 VANI

09514 Magnolia

● **09516** Verde



+10 CASSETTE

MOBILE cm.72x45x100 h
CON 1 ANTA E 3 VANI

● **09507** Azzurro

● **09508** Verde



+20 CASSETTE

MOBILE cm.106x45x100 h
CON 1 ANTA E 3 VANI

● **09510** Azzurro

● **09511** Verde





Cassette Smile

Colorate, capienti cassette in materiale acrilico con spigoli arrotondati, vanno a completare le cassettiere e i mobili a giorno della linea **Milano Arredi** e consentono di mantenere in ordine la classe e il materiale didattico.



CASSETTA/CONTENITORE "SMILE"
cm.43x31,5x7,5 h

monocolore

- | | | |
|--------------|---|-------------|
| 07720 |  | Giallo |
| 07721 |  | Rosso |
| 07722 |  | Verde |
| 09627 |  | Blu |
| 07926 |  | Trasparente |

CASSETTA/CONTENITORE ALTA
cm.43x31,5x15 h

monocolore

- | | | |
|--------------|--|--------|
| 10291 |  | Giallo |
| 10292 |  | Rosso |
| 10293 |  | Verde |
| 12866 |  | Blu |

NOVITA'

GUIDA PER CASSETTE

07729

coppia guide antiribaltamento per cassette SMILE

Bauletti trasparenti

pratici, resistenti e con coperchio!



12358/1

bauletto piccolo (in plastica)

CM.21x15,5x11,5

12358/2

bauletto medio (in plastica)

CM.26x18,5x13,5

12358/3

bauletto grande (in plastica)

CM.38x27x16,5

652 Arredo

Contenitore con portaetichette

4 PEZZI



4 Pezzi - cm.11x16,8x7,6 h

11811 Rosso

11812 Blu

30 Pezzi - cm.16x25x12,9 h

● **11823** Rosso

3 PEZZI



3 Pezzi - cm.16x25x12,9 h

11813 Rosso

11814 Blu



Cassette

PORTATA
KG.30



06986

cassetta/contenitore (in cartone)
cm.35x25x17 h
(minimo acquistabile 8 pezzi
assortiti in 4 colori)



07123

cassetta/contenitore con coperchio
(in cartone) colore: avana
cm.35x25x17 h



09595

cassettiera antitrauma
+ 6 cassette/contenitore (in cartone)
cm.36x60x73 h



07735

cassetta/contenitore piccola
(in cartone) cm.31,5x43x7,5 h
(minimo 8 cassette colori:
4 verdi, 4 gialle)



07736

cassetta/contenitore media
(in cartone) cm.31,5x43x15 h
(minimo 8 cassette colori:
4 verdi, 4 gialle)



Queste cassette-portaoggetti in cartone possono sostituire i tradizionali contenitori in legno da inserire nei mobili, con il vantaggio di non provocare traumi ai bambini in caso di caduta del contenitore.

Arredi per adulti

Nelle foto: armadi e scrivania in multistrato di betulla, ideali per arredare aule, segreterie, ingressi, laboratori; disponibili in vari formati e combinazioni.

In basso, in primo piano: armadio art. 07843.; sedia art. 07921.



Sedie per adulti



07921

sedia impilabile (in legno) cm.42x43x83 h
altezza seduta: cm.46 - colore naturale

Robusta, durevole e
facilmente lavabile!



09722

sedia (in plastica) cm.46x52x80 h
altezza seduta: cm.46 - colore grigio



08124

ROBUSTE!
SOVRAPPONIBILI!

08126



08124

sedia senza braccioli cm.50x53x81 h
arancio

● **08126**

carrello per trasportare le sedie



I posti possono essere
facilmente aggiunti in
base alle esigenze!

● **08158**

struttura componibile (in plastica)
cm.160x80x80 h - altezza seduta: cm.45
Struttura, robusta, durevole e facilmen-
te lavabile.

Spogliatoio

Struttura portante in lamiera spessore 7/10. Antine montate su cerniere interne antiscasso, dotate di feritoie per areazione interna e chiusura con serratura a chiavi. Un ripiano posaogetti in ogni vano e portacartellino di serie.

Gli armadi in metallo vengono forniti montati!

08842

spogliatoio (in metallo)
cm.38x47x180 h - a 1 posto

08843

spogliatoio (in metallo)
cm.70x47x180 h - a 2 posti

08844

spogliatoio (in metallo)
cm.102x47x180 h - a 3 posti



Spogliatoio sporco/pulito

Struttura portante in lamiera spessore 7/10. Antine montate su cerniere interne antiscasso, dotate di feritoie per areazione interna e chiusura con serratura a chiavi. Ripiano posaogetti con sottostante separazione per indumenti sporchi e puliti, conforme alla norma D.P.R. 327/80. Portacartellino di serie.

Gli armadi in metallo vengono forniti montati!

08845

spogliatoio (in metallo)
cm.43x47x180 h
a 1 posto

08847

spogliatoio (in metallo)
cm.80x47x180 h
a 2 posti



08846

tetto inclinato (in metallo)
cm.43x47x200 h
per art.08845

08848

tetto inclinato (in metallo)
cm.80x47x200 h
per art.08847



Il tetto porta l'altezza totale dell'armadio a cm.200

Armadio



08833

armadio (in plastica) cm.35x43,8x181,8 h
ad 1 anta con 4 ripiani interni regolabili

656 Arredo

Aula riposo

Nella foto brandine Pisolo art. T108.
Sullo sfondo mobile/armadio per brandine art. 09846;
mobili della serie Simply art. 09848 e 09851.



Brandine per asili nido

Le brandine "NIDO" sono resistenti, sicure e conformi alle normative CE sulla sicurezza del bambino. Inoltre è disponibile un'ampia gamma di accessori per rendere ancora più accoglienti queste brandine. Consegnata montata.

Made in
ITALY

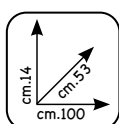

04844

brandina BABY PISOLO NIDO
cm.53x100x14 h peso kg.2

04844



06310

brandina NIDO con sponda
cm.53x100x21 h peso kg.4

06605

sponda per brandina
cm.53x100x8 h (per art. 04844)

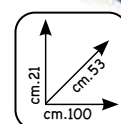

06310

brandina
baby PISOLO

- L'ORIGINALE!
- MADE IN ITALY!
- LA PIÙ VENDUTA!
- LA PIÙ LEGGERA!
- MONTATA!

Brandina per scuole materne

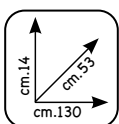

T108

T108

brandina PISOLO
cm.53x130x14 h peso kg.2,5

06606

sponda di sicurezza per brandina "Pisolo"
cm.53x130x8 h

05085

telo di ricambio per brandina (art. T108)



DIFFICILE DALLE IMITAZIONI
L'ORIGINALE

brandina
PISOLO

- L'ORIGINALE!
- MADE IN ITALY!
- LA PIÙ VENDUTA!
- LA PIÙ LEGGERA!
- MONTATA!

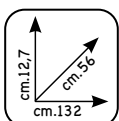

11807x4

4 brandine GONGOLO
cm.56x132x12,7 h



brandina
GONGOLO

658 Arredo

CARATTERISTICHE TECNICHE DELLE BRANDINE:

STRUTTURA:

- Resistente: grazie alla struttura tubolare in alluminio antiruggine che conferisce alla brandina una perfetta stabilità e leggerezza
- Angoli smussati per la totale sicurezza dei bambini

TELA:

- Atossica
- Conforme alle normative CE sulla sicurezza del bambino
- Traspirante grazie alla trama areata che ne regola la traspirazione
- Resistentissima grazie all'ottimo sistema di saldatura

PIEDINI:

- Resistentissimi, studiati per consentire di aggiungere le ruote
- Pratici: un semplice sistema ad incastro consente la sovrapposizione
- Angoli smussati per la totale sicurezza dei bambini



- 1 - LAVABILE
 2 - LEGGERA! Pesa solo 2 Kg
 3 - IMPILABILE
 4 - PERSONALIZZABILE! Con i contrassegni

LENZUOLO CON ELASTICI:

Lenzuolo bianco con 4 elastici agli angoli. In cotone 100%. Lavabile a 40° C.

ASILI NIDO

06311
lenzuolo cm.100x65
per art. 04844, 06310

SCUOLE MATERNE

T107
lenzuolo cm.115x65
per art. T108



SALVALETTINO PLASTIFICATO:

Telo salvalettino con 4 elastici agli angoli. Tessuto realizzato in Spugna puro cotone 100% gr/mtq 180/190. Applicazione con spalmatura ad alta resistenza, impermeabile. Qualità professionale.

08776
telo cm.56x102
per art. 04844, 06310

08775
telo cm.56x132
per art. T108, 11807



MATERASSINO:

Materassino con cordoncino agli angoli. Tessuto esterno realizzato in puro Cotone 100%.

06312
materassino cm.50x100
per art. 04844, 06310

04942
materassino cm.50x128
per art. T108, 11807



LENZUOLO A SACCO:

Lenzuolo a sacco con 4 elastici agli angoli, colore bianco. Realizzato in cotone 100%. Lavabile a 40° C.

08774
lenzuolo per art. 04844, 06310

08773
lenzuolo per art. T108, 11807



SACCO A PELO:

Sacco a pelo disegni fantasia. Piquet millerighe realizzato in puro Cotone 100%.

06313
sacco a pelo per art. 04844, 06310

05098
sacco a pelo per art. T108, 11807



COPERTINE:

Di ottima qualità, non infeltriscono e non fanno pallini. Antiacari e anallergiche, sono realizzate in 100% poliestere. Lavabili a 40° C. Peso totale: gr 180

08827
copertina cm.75x100 turchese per art. 04844, 06310

08825
copertina cm.100x150 turchese per art. T108, 11807



Biancheria

CUSCINO - Composizione:

- interno: 100% poliestere
- esterno: 100% cotone.
- Lavabile a 40° C.

05099

cuscino cm.30x50 circa
(per art. 04844, 06310, T108)

09962

federa per cuscino 100% cotone



Gambe rialzanti

Ideali per aumentare l'altezza della brandina. Le gambe rialzate evitano all'insegnante di chinarsi eccessivamente.

06315

set 4 gambe rialzanti per brandina Nido, Nido con sponde e Pisolo (art. 04844, 06310, T108)



Ruote con freno

Ruote con freno applicabili sotto la brandina per poterla spostare con facilità.

T109

4 ruote ø mm.50 con freno

09772

4 ruote ø mm.60 "Linea lusso"
(2 con freno e 2 senza)



Contrassegni/portafoto

Originale e pratico contrassegno/portafoto in materiale plastico trasparente, con retro adesivo. È possibile applicarlo sulla brandina, su appendiabiti, armadietti, spogliatoi... in questo modo il bambino riconoscerà le sue cose grazie alla fotografia, magari abbinata al suo nome.



08772

20 portafoto adesivi in plastica morbida cm.7x3 h

08771x10

10 portafoto adesivi in plastica rigida cm.6x4 h



08771



08772



660 Arredo

Brandina Blue

08643

brandina composta da una struttura con tubo in acciaio verniciato \varnothing mm.20 e telo traspirante intercambiabile, con pratica chiusura con velcro. cm.72x130x20 h

08642

telo di ricambio per brandina (per art.08643)



Brandina con doghe

07836

brandina per bambini (in plastica) cm.138x60x20 h con doghe in legno colore blu



Lettini "Nuvola"



- Resistenti! Struttura realizzata in poliuretano espanso densità kg.28 PS per metro cubo, rivestito con tessuto in tela spalmata
- Sfoderabili
- Igienici e facilmente lavabili!
- Antibatterici

* I COLORI POSSONO SUBIRE VARIAZIONI

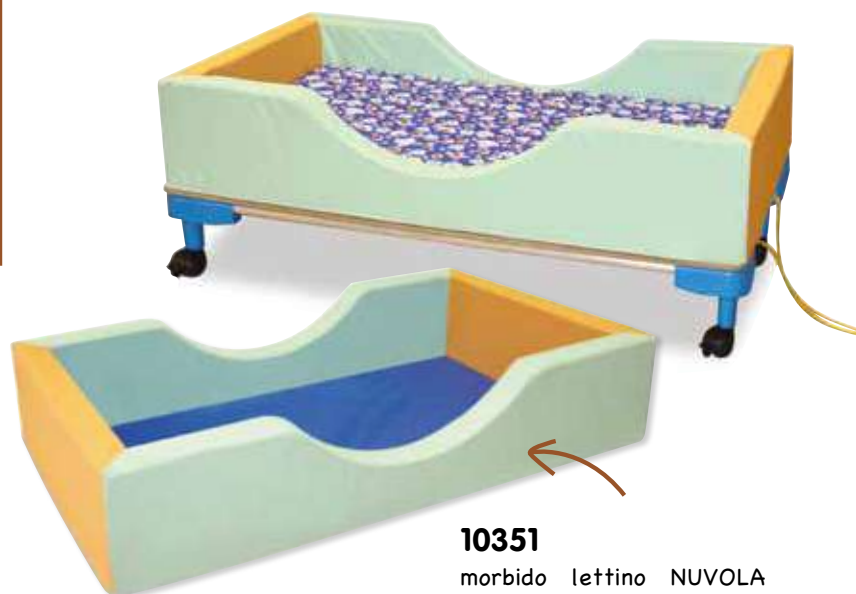

10353 carrello con ruote per lettino NUVOLA (art. 10351) cm.135x75

09982 lenzuolo sotto con elastici (per art. 09980, 09261, 09977, 09979)

09983 lenzuolo sopra bianco (per art. 09980, 09261, 09977, 09979)

09980 materassino sfoderabile per lettino NUVOLA (art.10351) cm.120x60x8 h

10351
morbido lettino NUVOLA
cm.135x75x25 h

Lettino "Futon"

11327

cm.120x70 (cm.50 interno) x5 h (cm.15 altezza sponda) colore blu

Morbido, leggero, impilabile, ignifugo.



Lettini



09979 - lettino colore naturale (in legno)
cm.126x66x30 h - linea **SIMPLY**

09977 - lettino colore naturale (in legno)
cm.126x66x30 h - linea **MILANO**



09980
materassino cm.120x60x8 h (per lettino art.09979)

09978
materassino cm.120x60x10 h (per lettino art.09977)

09982 - lenzuolo sotto con elastici

09983 - lenzuolo sopra bianco

10312 - telo salvalettino cm.60x100
in morbida spugna cotone 100%, antibatterico, antiacaro,
100% di impermeabilità ai liquidi.
Colore bianco, lavaggio a 60° C.

Lettino in legno



09261 - lettino cm.75x124,5x89 h

09980 - materassino per lettino

09982 - lenzuolo sotto con elastici

09983 - lenzuolo sopra bianco

Box pieghevole

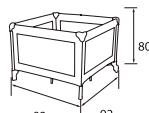

12,00 Kg



09553

box "CONFORT" cm.90x90x80 h - 12 kg.
Chiusura ad ombrello, doppio blocco di sicurezza
sul fondo, sacca per trasporto con maniglie.

Zanzariera per lettini



09550

zanzariera per lettini cm.140x60.
Rete zanzariera integrale con elastici,
adattabile a tutti i lettini in legno.



09551

zanzariera "Fly" cm.120x60. Rete zanzariera con
elastici, adattabile a tutti i lettini pieghevoli.

662 Arredo

Mobile per materassini

Mobile per materassini in multistrato di betulla, ideale per riporre cuscini, trapuntine e i materassini cm.120x60

● **10229**

mobile (in legno) per materassi (accessori esclusi)



CM.112x66x160



Materassini

Materassini con rivestimento in poliestere sfoderabile e lavabile in lavatrice a 30° C. Dotati di strisce di velcro per unire più materassini.

- Imbottitura: 100% spugna in poliuretano ad alta densità
- Rivestimento: tessuto poliestere sfoderabile



MATERASSINO CON VELCRO CM.120x60x5

10225 - rosso

10226 - blu

10227 - arancio

10228 - 3 materassini colori assortiti



INDICATI PER IL RIPOSO
DEI BAMBINI!

Pannello multitasche

Pannello multitasche realizzato in tessuto, igienico e facilmente lavabile è indicato nella zona riposo per riporre i peluches dei bambini in modo da ottimizzare lo spazio!

10354

pannello multitasche
(12 tasche) lavabile a 30°
e completo di asta per
il fissaggio



CM.70x110



Mobile/armadio per brandine

Mobile/armadio per brandine in legno conglomerato nobilitato. Spigoli arrotondati e piano antigraffio. **PUÒ CONTENERE FINO A 15 BRANDINE PISOLO** e permette di ottenere il massimo ordine nello spazio dedicato al riposo.



09846

mobile/armadio per brandine con 4 ripiani a giorno nel vano centrale e 2 ante laterali (all'interno di ogni anta ci sono 3 ripiani)



CM.45x208x180

IN OMAGGIO

UNA BRANDINA PORTABRANDINE (ART.09746) CHE PERMETTE DI RIPORRE FINO A 24 BRANDINE! DOTATA DI RUOTE COMPLETE DI FRENO DI SICUREZZA!



Brandina portabrandine

Caratteristiche portabrandina:

- Porta fino a 24 brandine
- Completo di 4 ruote da \varnothing 75 mm. della portata di 50 kg./cad., tutte con parte rotante antirumore
- Due delle quattro ruote sono complete di freno di sicurezza



NON SOLO BRANDINA MA ANCHE PORTABRANDINA!

* Il colore delle ruote potrebbe variare.

09746

brandina portabrandine PISOLO con ruote antirumore con freno di sicurezza

PORTA FINO
A 24
BRANDINE



Resistenti,
pratiche, sicure!

664 Arredo

Aule polivalenti



Nella foto: tavolo della linea Milano, art. 07794 e 07796; sedie in materiale acrilico e metallo art. 09386/01 e 09386/02, carrello libreria con ruote art. 08112. Sullo sfondo: composizione di mobili della linea Milano art. 07844, 07845 e 08448.



Tavolo-Carrello Jolly

Tavolo in legno con spigoli arrotondati. Stabile, resistente, di facile manutenzione, contenuto di formaldeide E1. Sotto il piano di lavoro è alloggiato un pratico portarotolo per la carta da disegno, da stendere lungo tutto il tavolo, alla cui estremità è fissato un righello tagliacarta che consente di tendere bene il foglio e di strapparlo quando il disegno sarà terminato.



08454

tavolo JOLLY per nido - con ruote



CM.120x43x55

08455

tavolo JOLLY per materna con ruote



CM.120x43x63



righello tagliacarta

Tavolo multiuso

In legno multistrato di betulla dotato di portarotolo per carta da disegno. I bambini potranno disegnare su tutta la lunghezza del tavolo semplicemente stendendo il foglio su di esso, e strappandolo quando il lavoro è terminato.



08169

tavolo multiuso in multistrato di betulla + rotolo carta da disegno mt.20



CM.120x43x58

08159

rotolo di ricambio carta da disegno



MT.20x35

Banco portacolori

Pratico e resistente, particolarmente indicato per scuole materne ed elementari. Costituito da due ampi ripiani sui quali appoggiare i colori. Il ripiano superiore é dotato di 16 fori di circa 7 cm di diametro, nei quali posizionare i bicchieri portacolori. Le pratiche ruote, consentono di spostarlo senza fatica.



08168

banco portacolori (in legno) con ruote. Contiene: 16 bicchieri di sicurezza, 2 bicchieri portapennelli \varnothing cm.10, 2 grandi bacinelle



CM.43x120x63

Mobile per pittura

7 CASSETTE
INCLUDE!



10349

mobile linea PITTURA
griglia asciugadisegni e 7 cassette incluse



CM.93x45x78



Aule polivalenti **667**

Carrelli per pittura

Carrelli in legno conglomerato nobilitato con ripiano in formica atossica. Con ruote.



11530

box (in legno) completo di 8 bicchieri per pittura



11328

carrello universale (in legno) con ruote



CM.52x70x60



11512

carrello per pittura (in legno) con box portabicchieri con ruote



CM.52x70x60

Carrelli multiuso in multistrato di betulla, con spigoli e angoli arrotondati e speciali vernici atossiche resistenti all'usura. Con ruote.



08103

carrello universale (in legno) con ruote



CM.52x70x60



08109

carrello pittura (in legno) con ruote e interno portacolori



CM.52x70x60

Carrello disegno/pittura

08113

carrello disegno con ruote e pannello (in legno) cm.33x67 dotato di pannelli e vani portacolori, utilizzabile da entrambi i lati.



CM.52x70x60



BIFACCIALE

Carrello giochi



08104

carrello giochi (in legno) con ruote



CM.52x70x60



10350

mobile linea GIOCO (2 vani e 7 cassette incluse) con ruote



CM.93x45x78



Carrello "acqua e sabbia"

Carrello in legno multistrato di betulla provvisto di un vano in cui è possibile alloggiare, a scelta, l'acqua o la sabbia. Particolarmente indicato come gioco collettivo per sviluppare le percezioni tattili, il contatto con diverse sostanze, i percorsi ecc. Dotato di ruote.

08105

carrello "acqua e sabbia" (in legno) con ruote, completo di pannello forato, vasca per acqua e sabbia e plastico con isoletta



CM.52x70x60



plastico con isoletta



Carrello portatutto "Vagabondo"

Carrello portatutto in MDF nobilitato. Completo di 4 capienti cassette SMILE con guide anticaduta che permettono di tenere sempre in ordine e a portata di mano giochi, colori, fogli di carta, libri, ecc...



09369

carrello "VAGABONDO" (in legno) con ruote + 4 cassette SMILE con guide anticaduta



CM.55x46x45

Mobile multiuso

La linea di prodotti Milano Arredi si arricchisce di un'ampia gamma di carrelli multiuso in multistrato di betulla, appositamente studiati per le collettività e per un uso massiccio: fabbricati nel pieno rispetto delle normative sulla sicurezza, con spigoli e angoli arrotondati e speciali vernici atossiche resistenti all'usura.



11365

mobile multiuso (in legno) - completo 4 cassetti



CM.101x101x28



Mini mobile multiuso

Carrello multiuso in multistrato di betulla, fabbricato nel pieno rispetto delle normative sulla sicurezza, con spigoli e angoli arrotondati e speciali vernici atossiche resistenti all'usura. Con ruote.

11419

MINI mobile multiuso (in legno) - completo 4 cassetti



CM.76x69x38



670 Arredo

Cavalletto lavagna

pag.59
gessi

BIFACCIALE



10399

cavalletto bifacciale (in legno)
con lavagna per gessetti
(area di lavoro cm.57x58)



CM.64x117,5



Portarotolo disegno

Supporto a muro per rotoli di carta. Consente di avere sempre a portata di mano dei bambini la carta per disegnare. La struttura del portarotolo, ben rifinita e smussata, è dotata di mensola per riporre i colori. Predisposizione sul pannello portarotolo degli appositi fori per ancoraggio a muro.

10118

portarotolo da disegno in legno
(carta esclusa)



CM.50x20x12

10119

portarotolo completo di pannello
in legno



CM.108x50x12

07976

rotolo di carta opaca gr.90



CM.42x50 MT.



10119



Cavalletto pittura

Questo resistentissimo cavalletto può essere utilizzato contemporaneamente da due bambini! Robusta struttura, interamente realizzata in legno, provvista da entrambi i lati di pratiche mensole con alloggiamenti per i bicchieri dell'acqua. Pinze reggifogli incluse.

BIFACCIALE



08110

cavalletto in legno
pittura bifacciale
(carta esclusa)



CM.60x125



pag.37
mobili per carta
e asciugadisegni

Cavalletto artistico



BIFACCIALE

Il Cavalletto Artistico include:
gessi colorati, rotolo di carta,
bordo bianco magnetico,
lavagna per gessi, barattoli
per vernice, cancellino

BJ420

cavalletto Artistico per
ragazzi (in legno)



CM.41x48x89

BJ421

rotolo di carta per cavalletto
(per art.BJ420)



CM.30x15 MT.



Cavalletto bifacciale

Cavalletto per bambini con due facciate: lavagna sintetica verde per gessetti e bianca per marcatori a secco/acquerelli dall'altro. Completo di mensola portacolori, portarotolo per carta e sistema di regolazione semplicissimo. Adatto per bambini di età superiore ai 3 anni. Peso 10 kg



BIFACCIALE

05750

cavalletto pittura bifacciale (carta esclusa)



CM.61x70x118

Angolo lettura



Librerie in legno

Mobili in legno appositamente studiati per esporre e ordinare al meglio libri, album, quaderni eccetera. Indicati per arredare l'angolo lettura di aule, laboratori, biblioteche.



10393

libreria con ripiani in tessuto



CM.72x38x111



06816

libreria con ripiani posizionabili a diverse altezze



CM.105x41,5x94

674 Arredo



NOVITA'

12867

libreria in legno



CM.100x30x85



11364

mini libreria + 2 cassetti



CM.38x50x60

Librerie e mobili in legno



NOVITA'

12871

libreria in legno



CM.120x30x90



NOVITA'

12872

libreria in legno



CM.120x30x90



NOVITA'

12874

libreria PIGGY in legno



CM.60x75x60



NOVITA'

12873

mobile casetta
in legno (rosso)



CM.60x30x120



NOVITA'

12869

mobile in legno
con 6 ripiani



CM.120x30x90

NOVITA'

12870

mobile in legno
con 12 ripiani



CM.120x30x90

NOVITA'

12868

mobile in legno
con finestra trasparente



CM.84x30x138



676 Arredo

Mobili/librerie

Fabbricate in legno conglomerato nobilitato, sopportano pesi notevoli senza rischiare di ribaltarsi.



09420

mobile panca (in legno) con 2 ante e ruote + 4 cassette incluse



CM.109x46x43



10357

materassino per mobile panca (per art. 09420)



CM.105x43x7



11602

libreria (in legno) con ruote con separatori portalibri estraibili (9 posti)



CM.52x70x61

08112

libreria (in legno) con ruote con separatori portalibri estraibili (8 posti)



CM.52x70x60



Mobile modulabile basso

Mobili realizzati in MDF placcato con pannelli colorati. Per garantire una maggiore sicurezza, ogni mobile è rifinito ai bordi con spigoli arrotondati. Questi mobili sono modulabili e affiancabili a piacere in modo da ottenere la lunghezza desiderata e sono adattabili in qualsiasi spazio: nella zona accoglienza per riporre scarpine e zainetti dei bambini, nell'aula gioco per riporre le scatole dei giochi, libri...

● **09927**

confezione 4 piedini (in metallo)



CM.10



● **09930**

mobile basso (in legno)



CM.40x24x57



● **09940**

mobile angolare basso (in legno)



CM.64x24x57

Librerie salvaspazio

Portariviste e libretti da fissare alle pareti.
Realizzati in resistentissimo metallo antiruggine.



INDICATI
ANCHE PER
CARTA E
CARTONCINO

08358



cm.75

cm.17

08357



cm.22

08358

libreria salvaspazio formato A5
9 vani - cm. 17x9x75 h



08357

libreria salvaspazio formato A4
6 vani - cm. 22x9x75 h

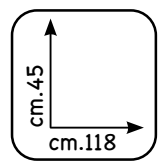

08646

libreria salvaspazio a parete
15 vani formato A4

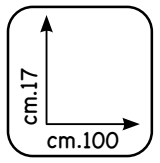

08644

mensola/portalibri "Jolly"
in tondino d'acciaio verniciato

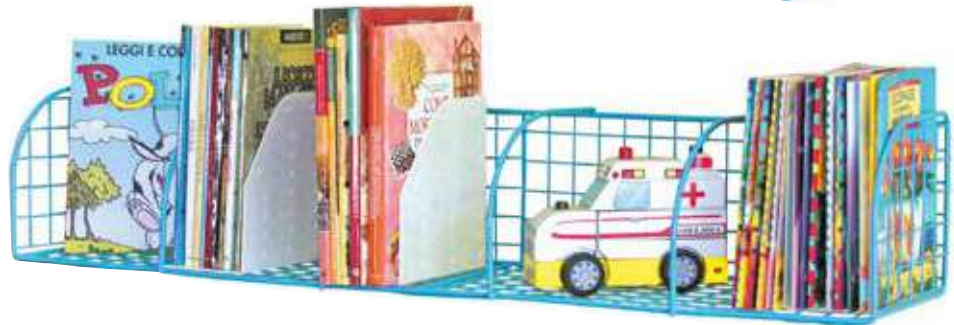

Angolo gioco



Gioco multiattività

Gioco multiattività in legno multistrato di betulla. Dotato di scala e parete per arrampicata. Indicato per affinare le abilità psicomotorie dei bambini di età compresa tra i 9 mesi e i 6 anni.

09368

"TANA PONTE" (in legno)



CM.150x54x75



scala 5 scalini

arrampicata
rivestita
in gomma
antiscivolo



Tana primi passi

Gioco multiattività in legno multistrato di betulla studiato per soddisfare le esigenze di sviluppo psicomotorio dei bambini di età compresa tra i 9 e 36 mesi. I bambini possono infilarsi nel tunnel gattonando o accovacciandosi, e sperimentare la sensazione legata al nascondersi, per poi guardare il mondo esterno dall'oblò, oppure possono aggrapparsi alla sbarra mancorrente sulla parete esterna della Tana e provare a muovere i primi passi in assoluta sicurezza, osservando la propria immagine riflessa nello specchio, o ancora possono utilizzare la parete sensoriale per affinare la motricità fine. La parte superiore della Tana Primi Passi può essere utilizzata come pratico ripiano su cui riporre libri o giocattoli. Bordi e angoli arrotondati, legno antisceglia privo di solventi chimici e di formaldeide, vernice speciale molto resistente e atossica.



09604

"TANA PRIMI PASSI" (in legno)
piano di appoggio cm.57x113
(struttura parzialmente montata)



CM.140x97x83



1



2



3



4

- 1 - Corrimano in acciaio verniciato e specchio
- 2 - Nuvola sensoriale e gioco con corde
- 3 - Oblò in plexiglass
- 4 - Gioco pregrafismo

680 Arredo



Tane per psicomotricità Mancorrenti - corrimano



● **10388**

"MOBILE MANIPOLATIVO" (in legno)



CM.80x80x80

Struttura in multistrato di betulla antisceggia composta da una coppia di mancorrenti, strumento utilissimo per aiutare i bambini più piccoli a compiere i primi passi in totale sicurezza. Particolarmente indicati anche per esercizi di riabilitazione e fisioterapia. Dotati di fori per il fissaggio alla parete.

07852

coppia di mancorrenti (in legno)



CM.200



Pannello "primi passi"

Parete composta da uno specchio in materiale acrilico infrangibile e antisceggia, con mancorrente in multistrato di betulla (dotato di appositi fori per il fissaggio al muro). Grazie a questa parete i bambini più piccoli avranno un saldo appoggio per compiere i primi passi in sicurezza, e potranno osservare allo specchio i loro movimenti.

07854

pannello in legno cm.102x88 con specchio cm.50x100 e mancorrente in legno



CM.102x88



Il grande castello

Realizzato in multistrato di betulla con angoli e spigoli arrotondati. Ha le forme di un vero castello, con tanto di torretta e stemma, finestra della Principessa, e tanti altri divertenti dettagli: scivolo, tunnel sotterraneo, parete per arrampicate, scaletta... Il pavimento interno del castello è trasparente, così i bambini potranno guardare cosa accade sotto, nel tunnel segreto! Un grande gioco, ideale per l'arredo di palestre, spazi gioco, ludoteche ecc...

● 08430

grande castello (in legno)
scala, scivolo, arrampicata: cm.78 h



CM.300x240x270



Piccolo castello

In multistrato di betulla, angoli e spigoli arrotondati. Dotato di scala, torretta, scivolo e nascondiglio sotterraneo.

● 08431

piccolo castello (in legno)



CM.235x40x185



Specchi multieffetto



10215

specchio liscio
con cornice imbottita



CM.37x46



10193

specchio con cornice imbottita
soggetto: bolle



CM.37x46



10194

specchio multieffetto con cornice imbottita
soggetto: sfere



CM.65x85

Questi specchi multieffetto dalle simpatiche forme sono infrangibili e antischeggia, per garantire la massima sicurezza del bambino. Ideali come complemento d'arredo per aule, camerette, palestre, laboratori.

09891

set 4 specchi multieffetto
soggetti assortiti



CM.30x40

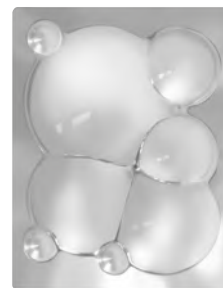

09891



09348

specchio con cornice (in plastica)
soggetto: sole



CM.60x60



09347

specchio con cornice (in plastica)
soggetto: sfere



CM.60x80

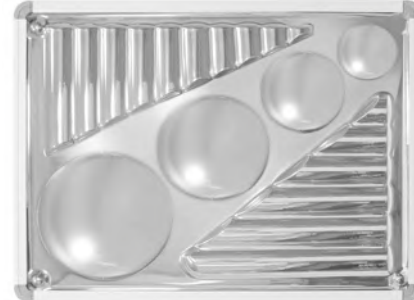

09418

specchio con cornice (in plastica)
forme assortite



CM.60x80

Specchi infrangibili di sicurezza

Questi specchi dalle simpatiche forme sono infrangibili e antischeggia, per garantire la massima sicurezza del bambino. Ideali come complemento d'arredo per rallegrare aule, camerette, palestre, laboratori. È inoltre possibile scrivere sugli specchi, utilizzando gli appositi marker per lavagne. Possono essere fissati a qualunque supporto purchè sia liscio, pulito e piatto. Nastro biadesivo incluso nella confezione.

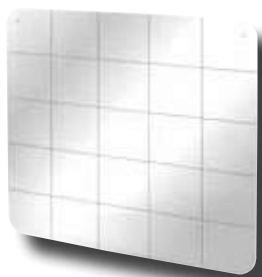

● **08041**
quadrettato



CM.50x50



08042
smile



∅ CM.50



08043
orso



CM.50 H



08044
tartaruga



CM.50 H

Specchi "Plex"

Questi specchi sono fabbricati in robustissimo materiale plastico antischeggia, infrangibile, rivestito con materiale riflettente. La cornice, in materiale acrilico, ha angoli arrotondati ed è priva di viti o bulloni, per assicurare la totale sicurezza del bambino. Gli specchi possono essere appoggiati a terra oppure possono essere facilmente appesi grazie ai pratici gancini a incastro, inclusi nella confezione.

SCRIVI E
DIPINGI LO
SPECCHIO CON
I MARKER
CANCELLABILI!



07163
specchio di sicurezza



CM.50x100

07164
specchio di sicurezza



CM.65x100



Specchi di sicurezza

ATTENZIONE: GLI SPECCHI DEFORMANTI IN MATERIALE ACRILICO, A DIFFERENZA DI QUELLI IN CRISTALLO, SULLA DISTANZA DEFORMANO LEGGERMENTE L'IMMAGINE - LE MISURE INDICATE SONO COMPRESIVE DI CORNICE IN LEGNO.

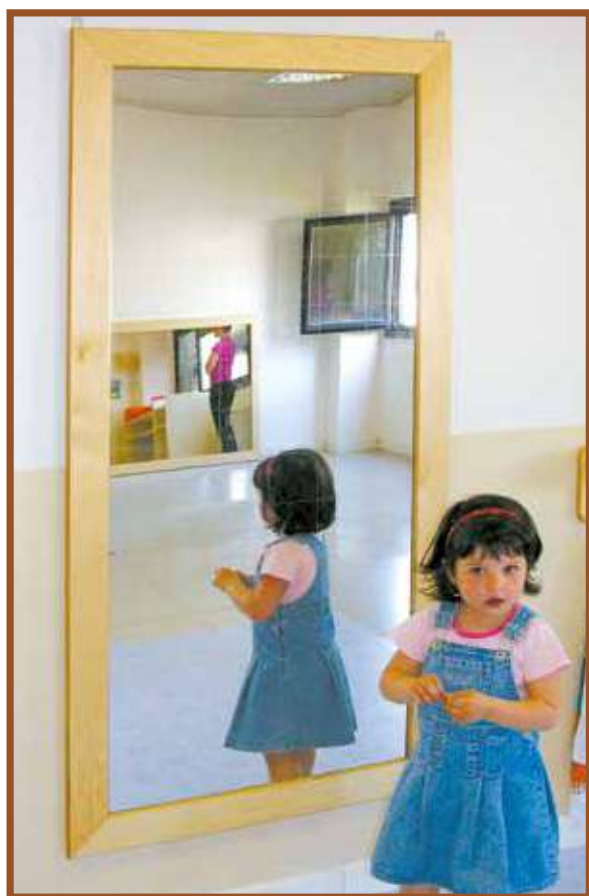

08034

specchio sicurezza
(in plastica) infrangibile



CM.64x134

08035

specchio sicurezza
(in plastica) infrangibile



CM.79x164

● **08039**

specchio sicurezza
(in plastica) infrangibile
quadrettato cm.10x10



CM.79x164



CON
CARRELLO
DOTATO DI
RUOTE!

08036

specchio sicurezza
(in plastica) infrangibile
con carrello dotato di ruote



CM.79x164

● **08040**

specchio sicurezza
(in plastica) infrangibile
quadrettato (cm.10x10)
con carrello dotato di ruote



CM.79x164

08037

specchio sicurezza (in cristallo)
Mirox Safe EN-1200
altamente riflettente



CM.84x134

Carrelli/mobile dei travestimenti

Veri e propri guardaroba provvisti di ripiani, barra appendiabiti e grande specchio. Indicati per bambini da 4 a 6 anni per favorire i processi di imitazione, drammatizzazione, scoperta di sé tramite i travestimenti.



09625

carrello/mobile dei travestimenti (in legno) con anta separè con specchio sicurezza



+4
ANNI



09617

carrello/mobile dei travestimenti (in legno) con specchio sicurezza



+4
ANNI

09626

carrello/mobile dei travestimenti (in legno) di betulla con specchio sicurezza



+4
ANNI

Mobile Beauty Center

+4
ANNI

09624

mobile "Beauty Center" (in legno) con specchio sicurezza



09620

mobile "Beauty Center" (in legno) con specchio sicurezza



Protezione e sicurezza



Rete tessuta ombreggiante frangivista

Rete tessuta tradizionale, rinforzata con bordo in PET nelle altezze da 1 a 2 metri, per applicazioni in verticale: il rinforzo facilita il fissaggio alle strutture di supporto e riduce fortemente la possibilità di strappo. Robusta, resistente, indemagliabile, si utilizza anche in orizzontale per proteggere dal sole qualsiasi spazio ricreativo all'aperto.

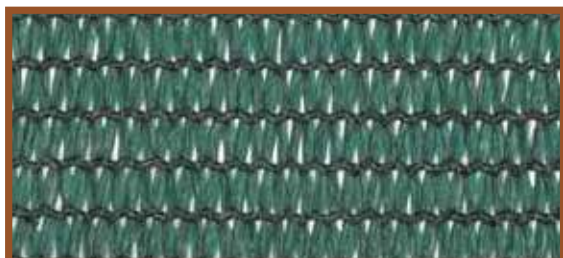

09876 - rete mt.1,5x5

09877 - rete mt.2x5



Recinzione removibile

Sistema modulare di pannelli composti da una rete estrusa in polietilene tesa da una struttura metallica, trattata con polveri indurenti e verniciatura per resistere agli agenti atmosferici. Leggero, stabile e poco ingombrante quando ripiegato, può essere spostato e trasportato facilmente. Per delimitare grandi aree le transenne possono essere unite l'una all'altra tramite appositi "ganci".

VANTAGGI:

- Leggera
- Facile da posare, rimuovere e trasportare
- Elevata resistenza alla luce
- Snodata



09878 - recinzione removibile mt.4x1

09879 - picchetto cm.60

09880 - piedino cm.17x48

09881x6 - 6 ganci unione cm.14



09878



09879



09880



09881

Colla per pavimentazione

Collante per pavimentazione: si utilizza per fissare la pavimentazione su superfici rigide (cemento, asfalto, mattonelle, piastrelle...). Utilizzo medio gr.500/mq.

07084

fusto kg.5



688 Arredo

Tappeto antitrauma

- 100% riciclabile
- I fori di 2,5cm consentono il drenaggio dell'acqua e la crescita dell'erba
- Adatto a qualsiasi condizione climatica
- Non richiede manutenzione
- Certificato Secondo EN 1177/2017
- TEST PAH: SECONDO EN 1176/1177- 2017

IDEALE PER:
Zone verdi, Colline,
Parchi gioco/Zone di
sport, Cortili



10346

tappeto antitrauma in gomma cm.100x150 spessore 2,3 cm
HIC 2600 mm (altezza di caduta)



PRIMA



DOPO

Erba sintetica

Rotoli di erba sintetica facilmente posizionabili con l'aiuto di biadesivo o colle specifiche a seconda delle esigenze. Può essere utilizzata sia per realizzare campi da calcio, tennis ecc., sia per rendere più piacevole un ambiente interno. L'erba sintetica isola dal freddo e attutisce gli urti, quindi è ideale anche all'interno di scuole materne ed elementari per arredare gli spazi destinati al gioco dei bambini. Ideale anche per tutte le superfici esterne come scuole, aree giochi che possono diventare un bellissimo prato. Tutti gli articoli sono resistenti alle intemperie ed ai raggi solari, con garanzia dai 4 ai 7 anni. DRENANTI FINO A 60 LITRI/MINUTO AL M2.

06773 - rotolo mt.2x2

06774 - rotolo mt.2x30 (totale mq.60)



PER
INTERNI
ED ESTERNI



Erba in polipropilene con rovescio in latex - altezza erba mm.8
fori drenaggio 90/m²

• CLASSIFICAZIONE AL FUOCO:

Classe 1 incollato
su supporto incombustibile

• COMPOSIZIONE:

100% fibra polipropilenica

• PESO:

1550 g/m²

• FONDO:

Lattice naturale autogiacente

• SOLIDITÀ ALLA LUCE:

Massima

I VANTAGGI DELL'ERBA SINTETICA:

- Igienica e atossica UNI EN 71-3:2002
- Nessun prodotto chimico o pesticida
- Nessun problema di allergia ai pollini
- Prato verde tutto l'anno
- Nessuna spesa di manutenzione
- Nessun impianto di irrigazione
- Risparmio fino al 70% di acqua
- Drenaggio di 60 l/m2/min



PRIMA



DOPO

Biball

Questa proposta è rivolta ai responsabili in materia di prevenzione e protezione ambiente, finalizzata in particolare alle protezioni di caloriferi, colonne, spigoli e pareti di scuole, palestre, ludoteche ecc... Nuovo sistema di protezione brevettato e denominato "BIBALL". Tutti gli elementi sono realizzati in materiale plastico a norma, levigato, arrotondato, molto robusto, antiurto e soprattutto inalterabile alle escursioni termiche.



KIT BIBALL

10039

kit cm.65 h

10040

kit cm.75 h

10041

kit cm.85 h

10042

kit cm.95 h

10043

kit cm.105 h

10044

kit cm.115 h

10049

kit per fissaggio a muro
contiene: 4 giunti, 4 raccordi, 4 viti con tassello

OGNI KIT È LARGO CM.20 E CONTIENE:
BIBALL, 2 BASI, 2 ASTE E TAPPI
DI CHIUSURA



10345

BIBALL - doppia pallina cm.20x10

ELEMENTO BIBALL:

Doppia pallina a sezione piatta, a stampo unico e dotata di doppi fori centrali per l'inserimento delle aste. Dim.: cm.20x10

ELEMENTO BASE:

Sostegno di fondo \varnothing cm.9x3 nel quale inserire l'asta che permette alla struttura la stabilità al suolo necessaria.

ELEMENTO ASTA:

A sezione circolare \varnothing cm.2, deve essere inserita in ogni base e fissata a pressione. Sono disponibili diverse misure in base all'altezza della protezione che si vuole realizzare.

ELEMENTO CHIUSURA:

Tappo a doppia entrata cm.14x3, permette di collegare e fissare a pressione le aste tra loro, nella parte superiore, rendendo la struttura compatta.

KIT DI FISSAGGIO:

Da ancorare al muro nel caso di protezione di caloriferi. Il kit è suddiviso in due pezzi: il primo filettato e dotato di forellino terminale per vite dovrà essere fissato a muro con vite e tassello lasciando 2-3 mm. di gioco al fine di permettere il successivo avvistamento nel secondo pezzo, filettato e corredato di foro centrale che dovrà essere infilato nelle due aste laterali (in basso e in alto) durante l'assemblamento della struttura BIBALL. Per quanto riguarda la protezione di colonne il sistema si chiude automaticamente in quanto le ultime due aste vengono collegate direttamente con le BIBALL.

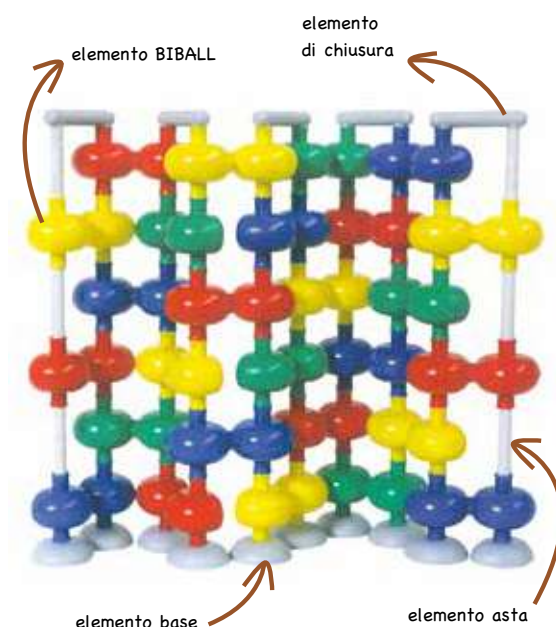

COME CALCOLARE LE MISURE:

Dopo aver identificato l'altezza del kit necessario, misurate la superficie da proteggere e quantificate il numero dei kit occorrenti tenendo conto che ogni kit copre una larghezza utile di 20 cm.

1. **Per il rivestimento di colonne** è necessario prevedere 5 cm. di aggiunta per ogni angolo. Ad esempio per rivestire una colonna quadrata di 30 cm. per lato occorreranno 7 kit ovvero 140 cm. (120 cm. per il perimetro della colonna + 20 cm. per i 4 angoli) Avendo una colonna alta ad esempio 135 cm. occorreranno quindi 7 kit dell' art.10046.
2. **Per il rivestimento dei copritermo** è necessario prevedere per ogni angolo 10 cm. aggiuntivi e pertanto per un termo lungo cm.120 e profondo cm.10 occorrerà sviluppare una rete della lunghezza di 160 cm. (8 kit) e prevedere l'ancoraggio a muro con il kit per fissaggio art.10049

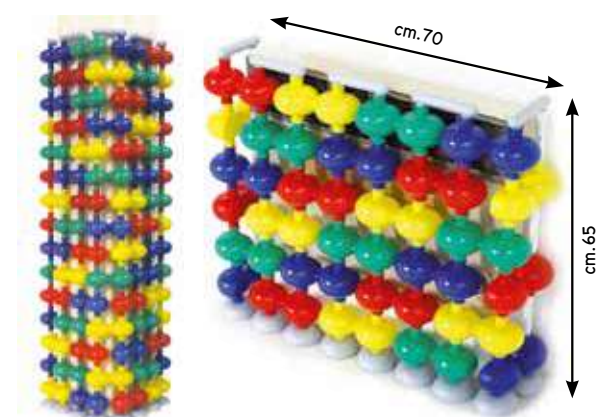

ISTRUZIONI PER IL MONTAGGIO:

Il sistema si sviluppa a kit (biball, 2 basi, 2 aste e tappi di chiusura). Si ottiene così una larghezza utile di cm.20 che può essere ampliata con multipli di kit (20/40/60/80/100 ecc...) Le aste sono di altezze diverse in funzione della parte da proteggere e vengono infilate a pressione nelle basi che daranno la stabilità all'intera struttura.

- 1 - disporre le aste a pavimento e inserire le aste a pressione
- 2/3 - inserire gli elementi BIBALL in modo alternato: la 1° fila orizzontale partendo dalla prima asta laterale, la 2° fila orizzontale partendo dalla seconda asta, la 3° fila partendo ancora dalla prima asta... ecc...
- 4 - raggiunta l'altezza inserire l'elemento di chiusura per rendere solida e compatta la struttura.
- 5 - applicare la struttura ottenuta al termosifone con il kit di fissaggio (in questo caso bisognerà prevedere di inserire il kit nelle due aste più esterne prima di chiudere la struttura).

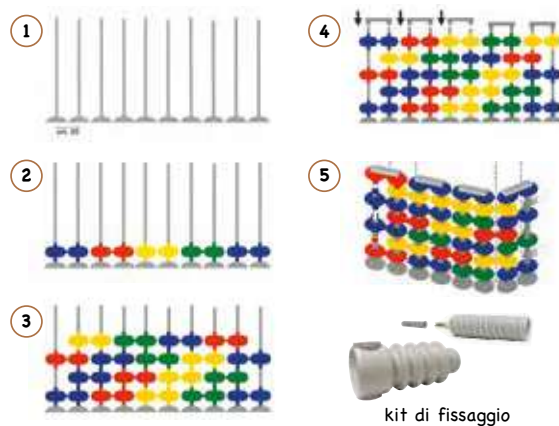

Protezioni



08251

set 4 coprispigoli. Facili da applicare su ogni spigolo, proteggono i bambini da traumi e ferite



08252

set 10 protezioni per prese elettriche con 4 chiavi. Proteggono i bambini da eventuali shock elettrici



08253

fermaporta da applicare sulle porte per prevenirne la chiusura accidentale, evitando che i bambini si facciano male alle dita



09270

chiusura di sicurezza per armadi



09268

set 2 chiusure di sicurezza multiuso. Ideali per vetrinette e mobili con pomelli



09269

set 2 chiusure di sicurezza per cassetti



09281

set 3 chiusure di sicurezza per ante e cassetti



09291

chiusura magnetica di sicurezza (chiave esclusa)



09290

chiave per chiusura magnetica (per art.09291)



09283

chiusura di sicurezza per finestre

Coprispigli e battiscopa

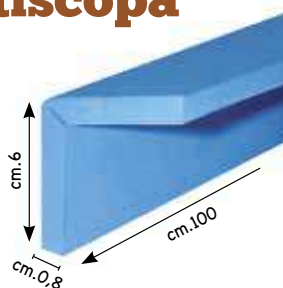

06596

conf. 4 coprispigli in EVA antitrauma cm.12x100x0,8 spes. + 1 tubetto colla universale ml.120

06600

conf. 4 battiscopa in materiale gommoso antitrauma cm.7x100x0,8

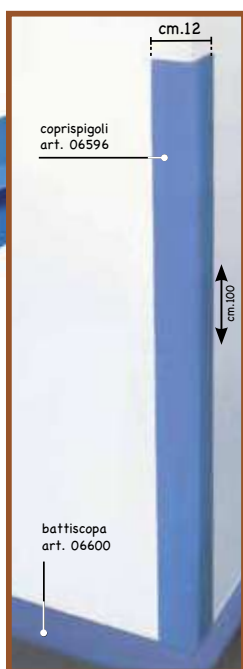

Paraspigli antiurto

Ignifugo Classe 1. Per il fissaggio a parete si consiglia l'uso del sigillante siliconico art. 05610. Lavabile con acqua e comuni detersivi.

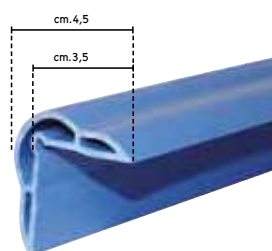

10367

paraspigli in PVC metri 1 spes. mm.2

05610

tubetto silicone gr.55



692 Arredo

Divisori di ambienti

Elementi componibili in materiale acrilico che consentono di realizzare una recinzione per delimitare gli spazi a seconda delle esigenze in modo sicuro e veloce.



08941

set 6 elementi divisori (in plastica)
pezzo singolo: cm.80x56x6 - dimensione totale: mt.4,80



NELLE CONFEZIONI SONO INCLUSI ANCHE I SUPPORTI CON FORI PER EVENTUALE FISSAGGIO AL PAVIMENTO CON TASSELLI O COLLANTE.



09373

attacco al muro per divisorio destro (in plastica)



09374

attacco al muro per divisorio sinistro (in plastica)



09372 - cancello doppio per divisorio per ambienti completo di perno per chiusura e supporti di sostegno (in plastica)

Staccionata

Pratici e robusti elementi in legno massello con bordi arrotondati, con solidi piedi di sostegno per evitare il fissaggio a pavimento. Ideali per realizzare una staccionata adattabile a ogni esigenza.

09197

staccionata (in legno)
cm.120x60 h con piedini di sostegno

12318

OFFERTA 5 staccionate (in legno)
cm.120x60 h con piedini di sostegno

SCONTO
10%



Divisori/staccionate



Robuste staccionate in **multistrato di betulla**, con bordi arrotondati, ideali per soddisfare ogni esigenza in asili, scuole materne, spazi gioco, ecc...

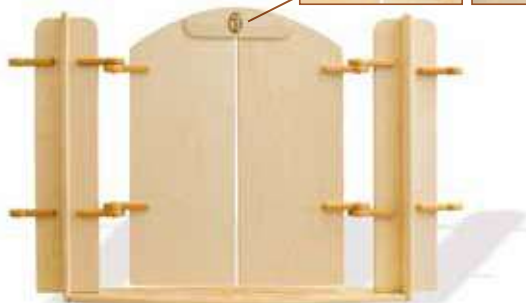

09606

staccionata/cancelletto (in legno)
cm.122x1,5x80 h



09602

coppia di cerniere



09603

pedino in legno (coppia)
cm.20x15,5 h



09607

spalla per ancoraggio
a muro cm.10x15x77 h

**CM.76
ALTEZZA**

09600

cm.80x1,5x76 h

09601

cm.160x1,5x76 h

Staccionata in legno
completa di cerniere
e piedini

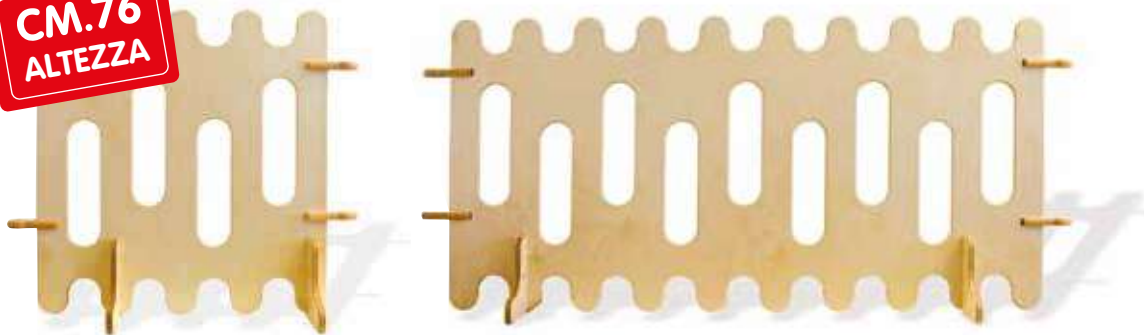

Divisori in **MDF** laminato acero, con bordi arrotondati, ideali per soddisfare ogni esigenza in asili, scuole materne, spazi gioco, ecc...

pag.510

sogetti decorativi
in legno



12839

cm.64,5x1,5x73,5 h

Staccionata in legno
completa di cerniere
e piedini

**NOVITA'
CM.69
ALTEZZA**

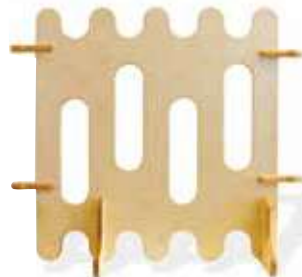

12719

cm.93x1,5x69 h

12720

cm.135x1,5x69 h

12721

cm.160x1,5x69 h





696 Piantane per gel igienizzante



697 Segnaletica COVID



698 Tappeto antibatterico

Prodotti per la prevenzione e il distanziamento

Nell'ultimo anno le nostre abitudini di vita sono state stravolte dalla comparsa del COVID19.

Al fine di garantire la massima sicurezza anche negli ambienti lavorativi e scolastici, proponiamo una selezione di articoli per il distanziamento, la prevenzione e la protezione individuale.

Siamo certi che un comportamento corretto da parte di tutti ci aiuterà a tornare presto alla normalità!



699

Supporti per dispenser gel

Made in ITALY

Posizionati all'ingresso o in punti strategici di scuole, aule, negozi, uffici, garantiscono visibilità al gel igienizzante invitando tutti i clienti ad utilizzarlo. Entrambi gli articoli sono dotati di sistema ANTI TACCHEGGIO con vite inclusa e portadispenser regolabile in altezza. La piantana da terra è adattabile anche all'altezza del bimbo.



12520

piantana gel da terra cm.140 h

12534

supporto gel da parete

Gel igienizzante e detergente

I prodotti potrebbero subire variazioni sia nelle etichette sia nella formulazione pur rispettando le normative del Ministero della Salute n.5443 del 22/02/2020 COVID-19.



12521/1000

gel idroalcolico igienizzante ml.1000 per il lavaggio rapido senza risciacquo delle mani. Dermatologicamente testato. Contiene percentuale di alcool.



12554

OXY detergente disinfettante ml.750, BIOCIDA PT-2. Pronto all'uso per superfici, bagni e tessuti. Contiene perossido di idrogeno.

Segnaletica

ADESIVI PER PAVIMENT, PARETI, ECC.

Da oggi, la sicurezza nei luoghi di lavoro sarà garantita da una buona organizzazione, che si otterrà con strumenti che sappiano comunicare con facilità. Adesivi stampati in alta definizione, resistenti e garantiti per una lunga durata.

- Realizzati con materiali di qualità
- Stampa fotografica in alta definizione
- Lunga durata



12541

adesivo per pavimento ø cm.30 - rosso
"Stai qui / Stand here"

12542

adesivo per pavimento ø cm.30 - blu
"Attendi qui il tuo turno"



12541



12542

12543

adesivo per pavimento cm.100x10 - rosso
"Si prega di attendere qui"

12543



12544

adesivo per pavimento cm.100x10 - blu
"Rispetta la distanza di sicurezza"

12544



12545

adesivo per pareti cm.21x30 - blu
"È obbligatorio indossare la mascherina"



12545

12546

adesivo per pareti cm.21x30 - blu
"È obbligatorio lavarsi le mani"



12546

12547

adesivo per pareti cm.21x30 - rosso
"Mantieni la distanza di sicurezza"



12547



12551

nastro ADESIVO segnaletico
giallo/nero mm.50x33 mt.



12552

nastro ADESIVO segnaletico
bianco/rosso mm.50x33 mt.



06099

nastro segnaletico bianco/rosso
mm.70x200 mt.

Tappeto antibatterico

Made in ITALY

Prodotto registrato presso il Ministero della Salute come Dispositivo Medico (classe 1) e garantito dal certificato CE.

Tappeto adesivo con 30 fogli numerati a strappo, realizzato in polietilene a bassa densità, ad alto potere collante e trattato con BIOCIDA costituito da principi attivi, atti ad inibire lo sviluppo dei batteri sulla superficie.

- Azione battericida e fungicida incorporata all'interno del tappeto.
- Strappi numerati: ogni foglio è numerato dal 30 all'1
- Nessun alone: il tappeto può essere posizionato ovunque senza lasciare residui.
- Non richiede cornici: grazie alla base adesiva aderisce completamente al pavimento.



12553x4

4 tappeti antibatterici cm.45x115
con 30 fogli numerati a strappo

Soprascarpe

Uno strumento indispensabile per garantire igiene in aule, negozi, uffici, ecc..

08945

busta 100 soprascarpe
per tutti gli usi (NO sanitario/ospedaliero)

08945/1000

busta 1000 soprascarpe
per tutti gli usi (ANCHE sanitario/ospedaliero)



Barriera protettiva in plex

Made in ITALY

Barriere protettive in materiale plastico trasparente e leggero. Indicate per scuole, uffici, attività commerciali, reception ecc. Resistenti e facilmente lavabili.

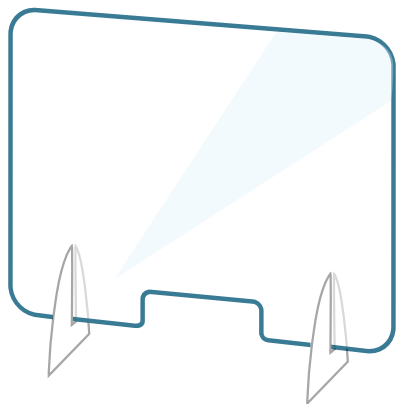

12548

barriera mm.785x600 **orizzontale**
con apertura e appoggi laterali

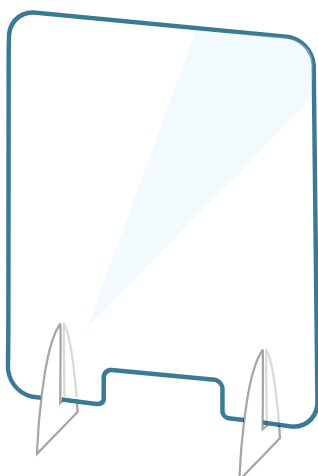

12549

barriera mm.785x600 **verticale**
con apertura e appoggi laterali



Barriera protettiva

- Sicura e atossica, facile da pulire
- Sistema di chiusura con velcro
- Facile da usare, non deve essere assemblata ma solo aperta.
- Materiale plastico traslucido che evita l'affaticamento degli occhi



12524

barriera protettiva cm.51x25x45 h
(in plastica)

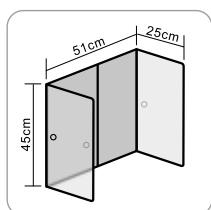

Articoli per il distanziamento

Tutti i prodotti riportati di seguito sono in plastica colorata atossica, ideale sia per ambienti interni che per esterni, e possono essere collegati l'uno con l'altro. In questo modo potrete realizzare con facilità postazioni e percorsi che favoriscano il distanziamento sociale in ogni ambiente.

Made in ITALY

CERCHI - colori assortiti

- 3024x4** - 4 cerchi - \varnothing cm.40
- 3025x4** - 4 cerchi - \varnothing cm.50
- 3026x4** - 4 cerchi - \varnothing cm.60
- 07991x4** - 4 cerchi - \varnothing cm.70
- 07992x4** - 4 cerchi - \varnothing cm.80
- 07993x4** - 4 cerchi - \varnothing cm.100



BASTONI ANTIURTO per percorsi psicomotori - 4 colori assortiti

- 3004x4** - 4 bastoni - cm.40
- 3005x4** - 4 bastoni - cm.50
- 3006x4** - 4 bastoni - cm.60
- 3008x4** - 4 bastoni - cm.80
- 3010x4** - 4 bastoni - cm.100
- 3015x4** - 4 bastoni - cm.150

minimo acquistabile:
4 pezzi della stessa misura
(uno per colore)

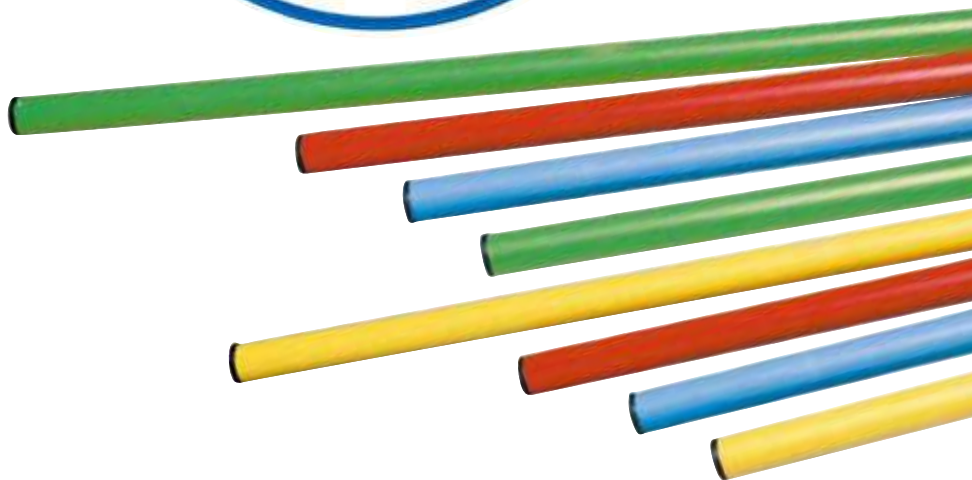

CONI - colori assortiti



CM.
35

2406x12

12 coni per percorsi con 12 fori
per abbinare bastoni didattici, ecc...
dimensioni: cm.35 h - colori assortiti



INDICATI PER
DELIMITARE PERCORSI!

09159

set 50 coni a disco \varnothing cm.20
con portadischi - 5 colori assortiti

Indice alfabetico

A

| | |
|----------------------------------|---------------|
| Abaci | 454-458 |
| Abecedario | 432 |
| Abiti per bambole | 507 |
| Accessori per modellare | 123-125 |
| Acqua e sabbia | 610-612 - 669 |
| Acquerelli | 67-69 - 110 |
| Adesivi | 249-253 |
| Adesivi distanziamento | 697 |
| Affilamine | 269 |
| Aggrappante | 224 |
| Aghi | 193 |
| Aghi per palloni | 605 |
| Alberi | 508-510 |
| Albero genealogico e da decorare | 154-155 |
| Album carta disegno | 3 - 93 |
| Album da colorare | 399 - 524 |
| Alimenti gioco | 423 - 497-499 |
| Allacciature e infilature | 436-440 - 442 |
| Altalena | 572 |
| Anelli didattici | 328 - 349 |
| Anelli ginnici e sensoriali | 601 |
| Anelli giocoleria | 593 |
| Anelli portachiavi | 209 |
| Anfore | 160 |
| Angolo delle scoperte | 545 |
| Animali gioco | 378 - 384-386 |
| Animali morbidi | 328 |
| Annaffiatoio | 480 - 611 |
| Antitrauma | 689 |
| Appendiabiti | 625-626 - 628 |
| Appigli per arrampicata | 567 |
| Aquart pennelli | 111 |
| Arca di Noè | 384 |
| Archetti per traforo | 228 |
| Archivio | 321 |
| Argilla | 133 |
| Aria compressa | 296 |
| Aritmetica | 454-467 |
| Armadi | 656 |
| Armadio ripostiglio | 324 |
| Arrampicata | 567-572 |
| Arredi morbidi | 532-548 |
| Arredo per casa delle bambole | 380 |
| Asciugadisegni | 36-37 |
| Asciugamani monouso | 326 |
| Asciugapassi | 557 |
| Asciugatore | 218 |
| Aspirapolvere | 504 |
| Asse da stiro | 504 |
| Assi ginniche | 569 - 572-573 |
| Aste per altezza | 628 |
| Attaccaglie | 322 |
| Attrezzi ginnici | 567-574 |
| Attrezzi per giardinaggio | 480-483 |
| Automobiline | 371 - 373-376 |
| Autosilos | 369-370 |
| Autotreno | 368 |

B

| | |
|--------------------------|---------------------|
| Bacheche | 315 |
| Bacheche da decorare | 155 |
| Bacchette e ciotole | 97 - 99 - 101 - 199 |
| Bacchette per seriazioni | 453-454 |
| Badminton | 605 |
| Bagnadita | 290 |
| Bagnetto | 624 |
| Balsa | 226 |
| Bambole e bambolotti | 506-507 |
| Bamboline | 377-379 - 382 |
| Banco del mercato | 500 |
| Banco falegname | 229 |

| | |
|--------------------------------------|-----------------|
| Banco portacolori | 84 - 667 |
| Banconote e monete | 502 |
| Banda dei numeri | 429 |
| Bande magnetiche portaetichette | 324 - 428 |
| Barattoli e flaconi | 100 - 476-479 |
| Barche | 375 |
| Barometro | 473 |
| Barriere protettive | 699 |
| Base per piegature | 44 |
| Base portafogli | 151 - 300 |
| Basi da taglio, da gioco e da lavoro | 125 - 287 |
| Basi per costruzioni | 356-357 |
| Basi per sculture | 137 - 181 |
| Basi per timbri | 81 |
| Basi per uova e sfere | 146 - 183 |
| Basket | 606-607 |
| Bastoncini | 184-185 - 207 |
| Bastone acrobatico | 593 |
| Bastoni didattici | 579 |
| Batterie | 296 |
| Batti e ribatti | 330 |
| Battiscopa | 692 |
| Baule degli abiti | 381 |
| Bauletti | 652 |
| Beauty set | 503 - 516 |
| Becchi | 187 |
| Biadesivi | 225 - 272 - 278 |
| Biancheria per lettini | 659-661 |
| Biball | 690 |
| Bicchieri | 260 - 494-496 |
| Bicchieri per pittura | 100 - 103 |
| Bidoni per rifiuti | 297 |
| Bigiotteria | 234-237 |
| Biglietti augurali | 245 |
| Bilance | 474-475 - 501 |
| Bilico ponte | 572 |
| Binari | 366 |
| Binocolo | 487 |
| Birilli | 596 |
| Black scrap | 87 |
| Blocchi logici | 468 |
| Blocchi per costruzioni | 348-360 - 383 |
| Blocco tonale e bitonale | 521 |
| Bocce | 596 |
| Bollo Ball | 607 |
| Bombe d'acqua | 254 - 597 |
| Bongo | 520 |
| Bordo magnetico | 324 |
| Bordo ondulato | 35 |
| Borse e borsette da decorare | 166 - 169 |
| Borse e sacchetti di carta | 246 - 318 |
| Bottoni | 186 - 439-440 |
| Bowling | 596 |
| Box per bambini | 662 |
| Box tattile | 471 |
| Bracciali con campanelli | 521 |
| Brandine e accessori | 658-664 |
| Brocche graduate | 478-479 |
| Bulini | 213 - 218 |
| Bulloni | 349 |
| Burattini | 157 - 517 |
| Bussola | 473 |
| Buste | 245-246 - 321 |
| Buste per documenti | 298 |
| Buste per plastificatrici | 296 |

C

| | |
|-------------------|-----|
| Cabasa | 521 |
| Calamite | 487 |
| Calcio balilla | 609 |
| Calcio e calcetto | 604 |
| Calcografia | 216 |
| Calcolatrici | 295 |

| | |
|----------------------------------|---------------------------------|
| Calcolo multibase | 464 |
| Caleidoscopio | 487 |
| Calibro | 310 |
| Calligrafia | 111 - 264 |
| Calza di Natale | 157 |
| Camerette per casa delle bambole | 380 |
| Camion | 374 - 377 - 614-615 |
| Campanelle | 187 |
| Campanelle delle melodie | 345 - 519 |
| Cancellotto per divisori | 694 |
| Cancellini | 314 |
| Canestri | 606-607 |
| Cannetè | 34-35 - 177 |
| Cannocchiale | 487 |
| Capanna presepe | 257 |
| Capelli per pupazzi | 148 |
| Cappelli e cappellini | 166 - 187 - 255 |
| Carboncini | 268 |
| Caricabatterie | 296 |
| Carrelli delle pulizie | 504 |
| Carrelli equilibrio | 577 |
| Carrelli multiuso | 667-668 |
| Carrelli psicomotricità | 585 |
| Carrello dei travestimenti | 516 |
| Carrello per la spesa | 501 |
| Carrello per piano luminoso | 346 |
| Carretto | 614 |
| Carriole | 616 |
| Carrozina per bambole | 505 |
| Carta abrasiva | 233 |
| Carta adesiva | 3 - 9 - 13 |
| Carta alveare | 14 |
| Carta animali | 15 |
| Carta avana | 6 - 243 - 319 |
| Carta bianca | 2-3 - 85 - 243 319 - 671-672 |
| Carta centimetrata | 6 |
| Carta cielo | 256-258 |
| Carta collage | 8-9 - 12-13 |
| Carta colorata e stampata | 4-23 |
| Carta costruzioni | 14 |
| Carta cotone | 21 |
| Carta crespata | 18-20 |
| Carta da decorare | 155-159 |
| Carta da disegno | 2-3 |
| Carta da pacco | 6 - 243 - 319 |
| Carta da regalo | 243 |
| Carta e cartoncino | 2-35 |
| Carta fantasia | 14-16 - 22-23 - 221-222 |
| Carta igienica | 326 |
| Carta lucidi | 301 |
| Carta metallizzata | 16 |
| Carta millerighe | 14 |
| Carta millimetrata | 301 |
| Carta monouso | 326 |
| Carta olografica | 16 |
| Carta origami | 17 |
| Carta paglia | 6 - 207 |
| Carta panno | 12-13 - 174 |
| Carta per acquerelli | 3 |
| Carta per cartonaggio | 23 |
| Carta per découpage | 221-222 |
| Carta per fondali | 2 - 256-258 |
| Carta per presepi | 256-258 |
| Carta per schizzi | 2 - 6 |
| Carta per scrapbooking | 22-23 |
| Carta pergamena | 7 |
| Carta pergamina | 11 |
| Carta plotter | 304 |
| Carta prato | 258 |
| Carta pressata | 145 |
| Carta quadrettata | 6 |
| Carta rasata | 8-9 |
| Carta riso | 21 |
| Carta roccia | 257 |
| Carta Spolvero | 6 |

| | |
|--|--------------------------|
| Carta spugna | 13 |
| Carta telata | 93 |
| Carta trasparente | 9 |
| Carta velina | 10-11 |
| Carta vellutata | 12-13 |
| Carta vetrata | 233 |
| Cartapesta | 121 |
| Carte da gioco | 400-401 - 460 |
| Carte e cartine geografiche | 528-530 |
| Cartella per fogli | 151 - 300 |
| Cartelle portadisegni | 38 |
| Cartelli stradali | 586-587 |
| Cartelline trasparenti per documenti | 298 |
| Cartellini per vasi | 483 |
| Carton Block | 35 |
| Cartonaggio | 23 |
| Cartoncini bianchi, neri, avana | 24 - 27 - 29 |
| Cartoncini/cartoni colorati e stampati | 4-5 - 24-35 |
| Cartoncino a specchio | 33 |
| Cartoncino bicolore | 28 |
| Cartoncino Bristol | 25 |
| Cartoncino fantasia | 30-33 |
| Cartoncino in striscioline | 26 |
| Cartoncino lavagna | 33 |
| Cartoncino Metalgraf | 215 |
| Cartoncino metallizzato | 32-33 |
| Cartoncino perlescente | 32 |
| Cartoncino satinato | 32 |
| Cartoncino telato | 27 |
| Cartoncino trasparente | 27 |
| Cartoncino vellutato | 31 |
| Cartone cuoio | 29 |
| Cartone ondulato | 34-35 - 177 |
| Cartone pesante | 28-2 |
| Cartone vegetale | 28 |
| Cartoni telati | 93 |
| Casa dei giochi | 381 |
| Casa delle bambole | 379-380 |
| Casacche | 86 - 166 |
| Caserna pompieri | 364 - 377 |
| Cassa per negozi | 501 |
| Cassetta degli attrezzi | 355 |
| Cassette contenitore | 645 - 652-653 |
| Cassette portavalori | 291 |
| Castelli | 383 - 682 |
| Catene didattiche | 349 |
| Catenella per ciuccio | 328 |
| Cavalcabili | 546 - 599 |
| Cavalletti per pittura | 85 - 94 - 114 671-672 |
| Cavallo a dondolo | 613 |
| Cavallo snodabile | 115 |
| Cellophane | 230 - 248 - 318 |
| Cellulosa | 145 |
| Cembali | 520 |
| Cemento | 126 |
| Ceppo per cerchi | 581 |
| Ceppo per forbici | 280 |
| Cera | 230 |
| Ceralacca | 111 |
| Ceramica | 121 - 127 |
| Cerchi cromatici | 347 |
| Cerchi didattici | 578 |
| Cerchi per insiemistica | 454 |
| Cerchiometri | 308 |
| Cerotti | 325 |
| Ceste portatutto | 645 |
| Cestini da decorare | 155 |
| Cestini per raccolta differenziata | 511 |
| Cestini per rifiuti | 297 |
| Chiavi dentizione | 328 |
| China | 112 |
| Chiodini e chiodoni | 322 - 440-442 |
| Chiusure di sicurezza | 692 |

| | |
|---------------------------------------|----------------------------|
| Chiusure per gioielli | 234 |
| Cibi gioco | 494-499 |
| Ciclo della vita | 405 - 486 |
| Cielo stellato | 256-258 |
| Cilindretti per abaco e insiemistica | 455 - 462 |
| Cilindri sensoriali | 601 |
| Cilindri sonori | 345 |
| Cilindro delle forme | 330 |
| Ciniglia | 189 |
| Cintura campanelli | 521 |
| Cintura degli attrezzi | 355 |
| Ciotole e bacinelle | 97 - 99 - 101 - 260 |
| Ciotole per seriazioni | 453 |
| Circuiti curve e onde | 434 |
| Circuiti per auto e trenini | 363-367 370-372 |
| Città dei trasporti | 370 |
| Classificatori | 291 |
| Clave e clavette | 592 |
| Clave musicali | 521 |
| Clessidre | 450 |
| Clip fermacarte | 293 - 317 |
| Cocodrillo dei numeri | 416 |
| Colla glitter | 200-203 |
| Colla per piastrelle e pavimentazioni | 126 - 688 |
| Colla spray | 224 |
| Collana dei numeri | 463 |
| Colle | 272-276 |
| Colle per découpage | 224 |
| Colle specifiche | 276 |
| Colle stick | 274 |
| Colle viniliche | 275 |
| Colorcrom | 16 |
| Colori a dita | 65-66 |
| Colori a olio | 110 |
| Colori a tempera | 62-64 - 67 87 - 104-105 |
| Colori acrilici | 90 - 106-109 |
| Colori della pelle | 64 |
| Colori per ceramica e vetro | 90-91 |
| Colori per contorni | 91 |
| Colori per tessuti | 92 |
| Colori per viso | 255 - 514-515 |
| Coltellini | 283 |
| Combina 4 | 425 |
| Compassi | 303 - 317 |
| Compensato di betulla | 149 |
| Coni per percorsi | 580 - 582 |
| Contentore per pannolini | 624 |
| Contentori archivio | 321 |
| Contentori per seriazioni | 453-454 |
| Contentori portatutto | 645 - 652-653 |
| Contrassegni | 623 - 660 |
| Coperte | 659 |
| Copertine per libri | 300 |
| Copricolonne | 555 |
| Coprilibri | 300 |
| Copriscarpe | 326 - 698 |
| Coprispigoli | 692 |
| Copritutto | 323 |
| Corde per saltare | 597 |
| Corde | 210 - 591 |
| Cordonatrice | 44 |
| Cordoncino elastico | 198 - 235 |
| Coriandoli | 255 |
| Comici per foto | 151 - 153 - 162 |
| Corone | 158 |
| Corpi per pupazzi | 148 |
| Corpo umano | 427-428 |
| Correttori | 271 |
| Corrimano | 681 |
| Corsa nei sacchi | 594 |
| Costruzioni | 348-360 - 383 |
| Cotone | 193 |
| Cotone da decorare | 166 |
| Country painting | 227 |
| Covid - prevenzione | 696-700 |
| Craft set | 190 |
| Cravatte e papillon | 158 |
| Creta | 121 |
| Cromatica | 347 |
| Cubetti multincastro | 353 |

| | |
|--------------------------------|---------------|
| Cubetti per infillature | 437 |
| Cubi impilabili | 335 |
| Cubi per insiemistica | 462 |
| Cucchiaini di legno | 151 - 153 |
| Cucina gioco | 493-499 |
| Cucito | 245 |
| Cucitrici | 286 |
| Culla per bambole | 505 |
| Curve e onde | 434 |
| Curvilinee | 306 |
| Cuscineti per timbri e tempere | 77 - 81 - 290 |
| Cuscini e cuscinoni | 547-548 - 660 |
| Cutter | 283 |

D

| | |
|-------------------------------|----------------------------------|
| Dadi | 462 |
| Dardi | 607 |
| Datari | 290 |
| Découpage | 221-224 |
| Decubox | 225 |
| Denaro gioco | 502 |
| Detersivi | 326 |
| Diabolo | 593 |
| Dischetti e telai per pompons | 189 |
| Dischetti per alberi | 511 |
| Dischi tattili | 338 |
| Disco oscillante | 577 |
| Disegnare con la sabbia | 346 |
| Disegni da dipingere | 93 - 164 |
| Distanziamento | 697-700 |
| Distributori nastro adesivo | 279 |
| Distuggidocumenti | 292 |
| Divanetti | 543 - 545 |
| Divisori per ambienti | 693-694 |
| Domino | 340 - 344 - 391 444-446 - 586 |
| Dondoli | 613 |
| Doratura | 220 |
| Dorsini legafogli | 299 |

E

| | |
|---------------------------|--------------------------|
| Ecopelle | 176 |
| Educazione stradale | 586-588 |
| Effetti | 205 - 347 |
| Elastici | 292 |
| Embossing | 218 |
| Equilibrio della frutta | 336 |
| Erba sintetica | 689 |
| Erbetta | 258 |
| Espanse | 228 - 238 - 304 |
| Esperimenti | 477-479 - 484-486 |
| Esplora la natura | 482-486 |
| Etichette autoadesive | 249-253 |
| Euro | 502 |
| Europoli | 425 |
| Evidenziatori | 266 |
| Famiglia/personaggi | 378-379 - 382 386-387 |
| Fantasmmini | 148 - 259 |
| Farfalle | 255 |
| Fasciatoi e accessori | 621-624 |
| Fattoria | 365 - 378 |
| Federe | 660 |
| Feltro | 172-173 |
| Feltro alta densità | 213 - 216 |
| Fermacampioni | 207 - 293 |
| Fermagli per carta | 294 |
| Fermagli per gioielli | 234 |
| Fermagli postali | 319 |
| Fermatovaglie | 262 |
| Ferro da stiro | 504 |
| Ferrovia | 363-368 - 372 |
| Fette di albero | 184 |
| Fettucce elastiche | 292 |
| Fiabe - personaggi | 382 - 387 |
| Figure cromatiche | 347 |
| Filati | 193 - 209 |
| Fili | 208-209 - 234-235 |
| Fili bigiotteria | 234-235 |
| Film plastico da decorare | 164 |

| | |
|------------------|-------------------------|
| Film trasparenti | 298-300 |
| Filo animato | 137 - 207-208 - 234-235 |

F

| | |
|----------------------------------|---|
| Filo fiori plastificato | 19 |
| Finestra per ritratti | 489 |
| Finestre 3D | 245 |
| Finto muschio | 258 |
| Finto piombo | 91 |
| Fiocchi di neve | 204 |
| Fiocchi per pacchi dono | 244 |
| Fiorincastrì | 351 |
| Fischietto | 597 |
| Fisioterapia | 599-603 |
| Fissativi spray | 113 |
| Flaconi e barattoli | 65 - 476-479 |
| Flashcards | 400-401 - 460 |
| Flauto | 519 |
| Flessometri | 309 |
| Fogli adesivi trasparenti | 165 - 301 |
| Fogli cromatici | 347 |
| Fogli magnetici | 279 |
| Fogli metallizzati | 220 |
| Fogli trasparenti per proiezioni | 298-299 |
| Foglia oro | 220 |
| Foglietti per appunti | 289 |
| Fondali stellati | 256-258 |
| Forbici | 280-283 |
| Forbicine | 224 |
| Forme apribili | 139-145 |
| Forme e colori | 395 |
| Forme geometriche | 468-472 |
| Forme in cellulosa | 145 |
| Forme in polistirolo | 142-145 |
| Forme pretagliate | 80 - 170-171 173-174 - 177-180 - 227 |
| Forme tattili/sensoriali | 340 - 347 - 589 |
| Formicaio | 486 |
| Formine per paste da modellare | 124 |
| Formine per sabbia | 610 |
| Fornelli gioco | 493 - 495 |
| Fornello | 230 |
| Forno per ceramica | 136 |
| Foulard | 594 |
| Frammenti di doratura | 220 |
| Frazioni | 466-467 |
| Frigorifero | 493 |
| Frisbee | 596 |
| Frottage | 157 |
| Fungheggi manipolativi | 441 |
| Funghi per costruzioni | 350 |
| Fustellatrice | 43 |
| Fustelle | 39-43 |
| Futon | 552 |

G

| | |
|----------------------------|-------------------------|
| Gambe rialzanti | 660 |
| Ganci per bastoni e cerchi | 581 |
| Gancini per quadri | 207 - 322 |
| Gancini per sfere e uova | 146 |
| Garage delle auto | 369-370 |
| Garze gessate | 137 |
| Gavettoni | 597 |
| Gel igienizzante | 696 |
| Gemme | 187 |
| Geografia | 528-530 |
| Geo-magnetica | 353 |
| Geometria | 468-472 |
| Geopiano | 471 |
| Gessi | 59-61 |
| Gesso alabastrino | 126 |
| Gesso liquido e stick | 49 |
| Gesso primer | 113 |
| Gesso spray | 59 |
| Ghiaccio per decorazioni | 204 |
| Ghiaccio secco | 325 |
| Ghiaia | 258 |
| Giardinaggio | 480-483 |
| Giochi degli specchi | 488-489 |
| Giochi delle forme | 330 - 333 |
| Giochi di equilibrio | 336-337 - 451 - 569-577 |

| | |
|-------------------------------|----------------------------------|
| Giochi di società e da tavolo | 391-398 - 425 490-491 |
| Giochi magnetici | 353 - 381 - 407 412-414 - 422 |
| Giochi matematici | 454-467 |
| Giochi sensoriali | 338-345 - 404 - 471 |
| Gioco degli anelli | 597 |
| Gioco del martello | 470 |
| Gioco dell'oca | 425 |
| Gioco delle biglie | 577 |
| Gioco delle carezze | 342 |
| Giocoleria | 592-593 |
| Giraffa trainabile | 329 |
| Girello | 329 - 643 |
| Glass deco | 91 |
| Glisso | 352 |
| Glitter | 200-203 |
| Globi geografici | 528 |
| Go Go | 373-376 |
| Golf | 607 |
| Gomitoli | 193 - 211-212 |
| Gomma Crepp (EVA) | 167-171 |
| Gomme per cancellare | 271 |
| Gommini adesivi | 272 |
| Gommoni | 375 |
| Gommy | 80 |
| Gonfiabili | 599 |
| Gonfiatore per palloncini | 597 |
| Goniometri | 305-306 - 316-317 |
| Graffiti | 286 |
| Graffette | 294 |
| Graffiti | 87 |
| Grembiuli | 86 - 166 |
| Grilli salterini | 424 |
| Grip per matite | 54 |
| Gru | 369 |
| Gufo | 521 |

H-I

| | |
|--------------------------|-----------------|
| Heat gun | 218 |
| Hula hoop | 596 |
| Identiquiz | 425 |
| Igrometro | 473 |
| Imballaggio | 318-323 |
| Imbuti | 477 |
| Impara l'inglese | 391 - 393 |
| Impariamo a contare | 463 |
| Impilabili | 333-337 |
| Impugnatura campanelli | 521 |
| Impugnatura per matita | 54 - 267 |
| Incastri | 350-354 |
| Inchiostri | 112 - 214 - 217 |
| Incisori per legno | 232-233 |
| Indiani | 386 |
| Infillature e allacciate | 436-440 - 442 |
| Insalata | 497 |
| Insetti | 385 |
| Insiemistica | 452 - 462 - 468 |
| Isola dei dinosauri | 386 |

J-K

| | |
|--------------------|-----------|
| Jeep | 373 |
| Juta | 175 - 210 |
| Kazoo | 519 |
| Kit primo soccorso | 325 |
| Kiwido | 593 |
| Kokiriko | 521 |
| Kubus | 469 |

L

| | |
|----------------------------------|-----------|
| Labirinti | 433 |
| Lacca per capelli | 255 - 515 |
| Lacci in tessuto | 208 |
| Lame per cutter | 283 |
| Lame per taglierine/cordonatrici | 44 |
| Laminato | 16 - 33 |
| Lana | 193 |
| Lastre per calcografia | 216 |
| Lastre per sbalzo | 212-213 |
| Lavagna magica | 415 |
| Lavagna mosaico | 441 |

| | |
|------------------------|-----------------------------------|
| Lavagne | 310-314 |
| Lavagne cartoncino | 33 |
| Lavagne cavalletto | 671 |
| Lavandino | 493 |
| Lavapennelli | 103 |
| Lavatrice | 493 |
| Legafogli | 299 |
| Legno da decorare | 149-153 - 181-186 - 226-227 - 260 |
| Lenti di ingrandimento | 291 - 484 - 487 |
| Lenzuola | 659 - 661 |
| Lenzuolo medico | 326 - 622 |
| Lettere e numeri | 159 - 414-417 |
| Lettoni e accessori | 658-664 |
| Lettoni per bambole | 505 |
| Levapunti | 286 |
| Librerie | 674-675 - 677-678 |
| Libri | 524-527 |
| Libro magnetico | 423 |
| Linoleografia | 214-215 |
| Locomotive | 363-368 - 372 - 375 |
| Lotto | 344 - 448 |
| Luna park | 596 |
| Lunch box | 394 |

M

| | |
|----------------------------|---|
| Macchina del caffè | 494 |
| Macchina per la pasta | 137 |
| Macchinine | 371 - 373-376 |
| Magneti | 317 - 487 |
| Make up | 255 - 514-515 |
| Mamma chiocchia | 328 |
| Mancorrenti | 681 |
| Manga set | 111 |
| Mani e piedi | 590 |
| Mani snodabili | 115 |
| Manichini | 115 |
| Manico portapennini | 229 |
| Manine per infilature | 439 |
| Manuali creativi | 526-527 |
| Mappamondo | 528 |
| Maracas | 520 |
| Marcamento del suolo | 588 |
| Marionette | 517 |
| Marker | 46-50 - 111 - 160-161 - 264-265 |
| Maschere e mascherine | 157-159 - 255 - 512-513 |
| Maschere normografiche | 308 |
| Maschere per embossing | 218 |
| Masking tape | 277 |
| Mastice | 276 |
| Matassine | 193 |
| Matematica | 454-467 |
| Materassi e materassini | 546-554 - 556 - 613 - 623-624 - 659 - 663 |
| Materiali da imballaggio | 318-323 |
| Matite | 51-54 - 267 |
| Matrioska | 406 - 470 |
| Mattarelli | 123 |
| Mattoncini per costruzioni | 348-360 - 383 |
| Mattonelle puzzle | 554 - 563-566 |
| Mattoni maxi | 358-362 - 583 |
| Mattoni per percorsi | 583 |
| Meccanismo per orologi | 183 |
| Meccano | 355 |
| Medium per pittura | 88 |
| Memo Board | 151 - 300 |
| Memory | 341 - 345 - 390 - 392-393 - 395 - 419 - 449 |
| Mensole | 627-628 - 630 |
| Mercatini | 500 |
| Metalgraf | 215 |
| Metallofoni | 523 |
| Metri | 309 |
| Metro cubo e quadro | 472 |
| Mezze mollette | 186 |
| Mezzi da lavoro | 369 - 374 |
| Mezzi di trasporto maxi | 614-615 |
| Mi vesto | 381 |
| Microonde | 493 |

| | |
|-------------------------------|-----------------------------|
| Mine | 268 |
| Mirette per modellare | 135 |
| Mobili | 646-651 - 667-670 - 675-677 |
| Mobili cucina gioco | 493-494 |
| Mobili per brandine | 661 - 664 |
| Mobili per carta e cartoncini | 36-38 |
| Mobili per materassi | 551-552 - 663 |
| Modulix | 352 |
| Molle fermacarte | 293 - 317 |
| Mollette | 186 |
| Mondo | 426-427 |
| Monete e banconote | 502 |
| Monopattino | 617 |
| Moquette | 558-559 |
| Morsetti | 229 |
| Mosaico | 239-242 |
| Motrigioco | 351 |
| Mulino | 611 |
| Musica | 519-523 |

N

| | |
|----------------------------|-------------------|
| Nacchere | 520 |
| Nasi clown | 255 |
| Nastri adesivi strade | 372 |
| Nastri in carta e raso | 192 |
| Nastri per pacchi dono | 244 |
| Nastro adesivo e biadesivo | 277-279 - 324 |
| Nastro di carta | 277 |
| Nastro magnetico | 279 |
| Nastro ritmico | 594 |
| Nastro segnaletico | 697 |
| Natura | 480-486 |
| Nave dei pirati | 334 - 384 |
| Navi | 375 |
| Neve polistirolo | 204 |
| Normografi | 308 |
| Notes adesivi | 289 |
| Numeri e lettere | 414-417 - 429-432 |
| Numeri in colore | 459 |
| Nuvola arredi | 532-548 |
| Nylon | 235 |

O

| | |
|------------------------|-----------|
| Occhi mobili adesivi | 191 |
| Oceano degli incastri | 350 |
| OHP | 264 |
| Olio di lino | 113 |
| Ombrello del meteo | 336 |
| Omini acrobatici | 350 |
| Ondulatori per carta | 42 |
| Operazioni aritmetiche | 454-467 |
| Orchard | 389-399 |
| Origami | 17 |
| Orme motorie | 590 |
| Oro e argento spray | 259 |
| Orologi | 450 - 461 |
| Orsetti didattici | 452 |
| Ospedale | 377 |
| Osservare gli insetti | 484-486 |
| Ostacoli | 582 |
| Ovatta | 238 |

P

| | |
|------------------------|---------------|
| Pacco set | 319 |
| Paglietta | 248 - 318 |
| Paillettes | 236 |
| Pale e palette | 610-611 |
| Palestra | 567-574 |
| Palestrina | 329 |
| Palette cromatiche | 347 |
| Pallacanestro | 606-607 |
| Pallavolo | 605 |
| Palle e palloni | 598-609 - 612 |
| Palle per piscine | 547 |
| Palline da decorare | 139-142 - 145 |
| Palline per abaco | 455-456 |
| Palline per giocoleria | 593 |
| Palloncini | 254 - 597 |

| | |
|------------------------|---------------------------------|
| Pallottolieri | 454-458 |
| Panche e panchine | 640 |
| Pannelli manipolativi | 434-435 |
| Pannello multiattività | 332 |
| Pannello multifasce | 663 |
| Panno lana | 176 |
| Pantografo | 310 |
| Paperotti | 147 |
| Paracadute | 595 |
| Paraffina | 230 |
| Paraspigoli | 692 |
| Pareti morbide | 555 |
| Pareti per palestra | 567-571 |
| Party set | 157-159 |
| Passaggio | 643 |
| Passaggio per bambole | 505 |
| Passapartout | 162 |
| Pasta a rilievo | 83 |
| Pasta adesiva | 276 |
| Pasta di sale | 126 |
| Pasta neve | 204 |
| Paste da modellare | 118-122 - 133-134 |
| Pastelli | 55-58 |
| Pastiglie acquerelli | 67-69 |
| Patchwork | 238 |
| Pavimentazioni | 554 - 563-566 |
| Pecette | 289 |
| Pedana basculante | 577 |
| Pedane ginniche | 573 |
| Pelle ecologica | 176 |
| Pennarelli | 46-50 - 111 - 160-161 - 264-265 |

| | |
|-----------------------------|---|
| Penne | 266 |
| Pennelli e pennellesse | 70-72 - 74-75 - 111 - 116 |
| Pennini per incisione | 229 |
| Pentole e pentolini | 494-496 |
| Percorsi sensoriali | 338-340 |
| Percorso a rulli | 536 |
| Perforatori | 285 |
| Perforatori sagomati | 39-43 |
| Pergamene | 7 |
| Perle e perline | 181-182 - 184 - 194-198 - 236-237 - 436-437 - 440 |
| Personaggi | 377-379 - 382 - 384-387 |
| Pescapesci | 422 |
| Pesi per bilance | 475 |
| Pettine per tessitura | 193 |
| Piani di lavoro | 125 - 214-215 - 225 - 287 |
| Piano geometrico | 471 |
| Piano luminoso | 219 - 346 |
| Piano per stampi a rilievo | 127 |
| Piantana per gel | 696 |
| Piastra riscaldante | 216 |
| Piastrelle tattili | 338-340 |
| Piatti cinesi | 592 |
| Piatti e piattelli musicali | 522 |
| Piatti per alimenti | 261 |
| Piatti per pittura | 98 - 161 |
| Piatti per seriazioni | 453 |
| Piattine animate | 208-209 |
| Piano geometrico | 471 |
| Piano luminoso | 219 - 346 |
| Piano per stampi a rilievo | 127 |
| Piantana per gel | 696 |
| Piastra riscaldante | 216 |
| Piastrelle tattili | 338-340 |
| Piatti cinesi | 592 |
| Piatti e piattelli musicali | 522 |
| Piatti per alimenti | 261 |
| Piatti per pittura | 98 - 161 |
| Piatti per seriazioni | 453 |
| Piattine animate | 208-209 |
| Piedi e mani | 590 |
| Piedi per pupazzi | 181 |
| Piedistalli | 137 - 181 - 207 |
| Piegafili | 235 |
| Pieghe per carta | 44 |
| Pietra silicio | 217 |
| Pietre del fiume | 575 |
| Pietre per mosaico | 239 |
| Pigne | 184 |
| Pile | 296 |
| Ping pong | 609 |

| | |
|--------------------------------|-----------------------------------|
| Pinze | 235 |
| Pinzette | 194 - 239 |
| Pipette dosacolori | 112 - 476 |
| Piramidi | 335-337 - 451 - 613 |
| Pirati | 159 - 334 - 384 |
| Pirografi | 232-233 |
| Piscine | 547 |
| Piste per auto e trenini | 363-367 - 370-372 |
| Pistole per colla a caldo | 273 |
| Piume | 190 |
| Pive | 198 |
| Pivilex tappeti | 556 |
| Pizza - gioco | 394 - 423 - 466 |
| Plastica a bolle | 323 |
| Plastica ondulata | 35 |
| Plastica trasparente | 230 - 248 - 298-300 - 318 |
| Plasticatrici | 296 |
| Plastilina | 118-120 - 133 |
| Plasto Smalt | 205 |
| Plastomosaico | 240-241 |
| Plastovetro | 163 - 165 |
| Pluritunnel | 544 |
| Pluviometro | 473 |
| Polistirolo | 142-145 - 204 |
| Politex | 174 |
| Poli-vinyl pannelli | 214 |
| Poltroncine | 543 |
| Polvere di ceramica | 127 |
| Polveri per embossing | 218 |
| Pomelli manipolativi | 440 |
| Pompa per palloncini/palloni | 597 - 605 |
| Pompette per colori | 65 |
| Pompieri | 364 - 377 |
| Pompons | 188-189 |
| Ponte equilibrio | 572 |
| Ponte per circuiti | 367 |
| Porporina | 200-203 |
| Porta dell'Elfo | 159 |
| Portabadge | 291 |
| Portabrandine | 661 - 664 |
| Portacarte | 36-38 |
| Portaceri | 230 |
| Portachiavi | 209 - 291 |
| Portaciuccio | 328 |
| Portacorrispondenza e riviste | 288 - 321 |
| Portaetichette | 324 |
| Portafoto | 151 - 153 - 162 - 207 - 623 - 660 |
| Portagessi | 60 |
| Portamatite da decorare | 155 |
| Portamatite e foglietti | 288-289 |
| Portamine | 268 |
| Portapalloni | 598 |
| Portapennelli | 102-103 |
| Portaposter | 302 |
| Portarotoli | 38 - 85 - 671 |
| Portastampi | 127 - 230 |
| Portauova | 146 - 183 |
| Portavalori | 291 |
| Porte da calcio | 604 |
| Posate | 151 - 262 |
| Posate gioco | 494-496 |
| Poster da colorare | 156 |
| Prato artificiale | 258 - 689 |
| Predisegni | 93 - 164 - 228 - 239 |
| Pregrafismi | 429-433 |
| Presepe | 256-259 - 381 |
| Pressa per fiori | 154 |
| Pressa per timbri | 44 |
| Prima infanzia | 328-337 - 402-404 |
| Primer | 113 - 224 |
| Primi passi | 680-681 |
| Primo soccorso | 325 |
| Professionisti | 407 |
| Proiettori | 313 |
| Protezioni | 555 - 690-692 |
| Puntasecca | 217 |
| Punteruoli | 215 - 217 - 245 |
| Punti per cucitrici/sparapunti | 285-286 |
| Puntine da disegno | 295 |
| Punzecchio | 245 |
| Pupazzi per acqua | 328 |

| | |
|--------------------|--|
| Puzzle | 389 - 394~398 - 402~413 416~421 - 426~428 - 446~447 - 467 |
| Puzzle da colorare | 156 |

Q

| | |
|--------------------|-----------|
| Quadrati matrioska | 470 |
| Quadretti click | 352 |
| Quadriciclo | 329 - 617 |
| Quarzo | 205 |
| Quilling | 26 |

R

| | |
|--------------------------|-------------------|
| Racchette | 605 - 608~609 |
| Raccoglitori archivio | 321 |
| Raccolta differenziata | 511 |
| Rafia | 211 |
| Ragnatele | 259 |
| Rame per sbalzo | 212~213 |
| Ramino | 226 |
| Rane salterine | 424 |
| Rastrello | 610 |
| Recinzioni | 688 - 693~694 |
| Recipienti | 476~479 |
| Reflect view | 488 |
| Reggilibri | 288 |
| Reggimensole | 627 |
| Registratore di cassa | 501 |
| Registri | 298 |
| Regoli | 459 |
| Resina acrilica | 88 |
| Rete da pingpong | 609 |
| Rete ombreggiante | 688 |
| Retini adesivi | 302 |
| Riabilitazione | 599~603 |
| Righe e righelli | 305~309 - 316~317 |
| Righelli aritmetici | 465 |
| Rilegatura | 298~299 |
| Ripiani portacarte | 36~37 |
| Rivestimenti per libri | 300 |
| Rocchetti per infilature | 437 |
| Rocchettini | 244 |
| Rosaspina | 216 |
| Rotelle metriche | 309 |
| Rotoganci | 581 |
| Rotoli carta disegno | 2 - 85 |
| Rotor spin | 607 |
| Rugby | 605 |
| Rulli per pittura | 74~76 |
| Ruota gigante | 575 |
| Ruota metrica | 472 |
| Ruote con freno | 660 |
| Ruspe | 374 |

S

| | |
|--------------------------------|---|
| Sabbia da gioco | 121 - 346 - 433 - 612 |
| Sabbia decorativa | 205 |
| Sabbie | 612 - 669 |
| Sacche | 166 - 297 |
| Sacchetti di carta | 246 - 318 |
| Sacchi e sacchetti per rifiuti | 297 - 326 |
| Sacchi per corsa | 594 |
| Sacco a pelo | 659 |
| Sacco psicomotorio | 594 |
| Sagome logiche | 468 |
| Sagome pretagliate | 80 - 168~171 173~174 - 177~180 - 227 |
| Salvacolore | 100 |
| Salvadanajo | 501 |
| Salvalettino | 659 |
| Sassolini | 239 - 258 |
| Sbalzo | 212~213 |
| Scaglie | 204~205 |
| Scagliola | 126 |
| Scala spalliera | 567 - 570~571 |
| Scarpiera | 631 |
| Scatola dei sogni | 544 |
| Scatola delle forme | 330 |
| Scatole | 225 - 247 - 320 - 653 |
| in cartone e metallo | |
| Scatolette fiammiferi | 190 |

| | |
|------------------------|--------------------------------------|
| Scatolette in legno | 150 |
| Scavini | 215 - 229 |
| Schede pregrafismi | 430 - 432 |
| Schema corporeo | 428 |
| Schemi di proiezione | 313 |
| Schiuma spray | 255 |
| Scodellini per pittura | 95 |
| Scopa e paletta | 504 |
| Scopina scacciaguai | 192 |
| Scoubidou | 209 |
| Scovolini | 189 |
| Scrapbooking | 22~23 - 43~44 192 - 221 - 249~253 |

| | |
|----------------------------------|---|
| Scratch Art | 87 - 215 |
| Sdraietta | 643 |
| Secchielli | 611 |
| Sedie | 639~643 - 655 |
| Sedute | 543 - 545 - 639~643 - 655 |
| Seggiolini e seggioloni | 643~644 |
| Seggiolone per bambole | 505 |
| Segnaletica Covid | 696 |
| Segnali stradali | 586~587 |
| Semafori | 587 |
| Semisfere | 576 - 601 |
| Separatori per forme apribili | 141 |
| Serpente dei numeri | 416 |
| Serre | 481~482 |
| Setacci | 611 |
| Setaccio per pittura | 76 |
| Sfere kristall | 139 |
| Sfumini | 268 |
| Sgorbie | 215 - 229 |
| Shopping bag | 246 - 318 |
| Sigillapannolini | 624 |
| Sigillo per ceramica | 111 |
| Silicone spray | 126 |
| Sistema metrico decimale | 465 |
| Sistemi di misurazione | 473 |
| Soffietti | 244 |
| Soggetti in legno per arredo | 510 |
| Soggetti magnetici | 412~413 |
| Soggetti per alberi | 511 |
| Solidi geometrici | 469~470 - 479 |
| Sonagli | 187 |
| Sonaglietti | 328 |
| Sottopentola | 179 |
| Sottovasi | 480 |
| Sovrascarpe | 326 - 698 |
| Spago | 210 - 319 |
| Spalliera | 567 |
| Sparapunti | 285 |
| Spatole | 73~74 - 116 - 346 |
| Specchi | 683~686 |
| Specchi deformanti e giochi | 488 |
| Specchi e specchietti decorativi | 206 |
| Spille da balia | 294 |
| Spilli | 238 - 294 |
| Spirale per bracciali e collane | 234 |
| Spogliatoi | 630~633 - 656 |
| Sponde per brandine | 658 |
| Spray | 59 - 88~89 - 113 - 126 - 201 224 - 255 - 259 - 276 |
| Spruzzatore | 76 |
| Spugne per pittura | 77~78 - 80 |
| Spugne per pulizie | 326 |
| Spugnette biadesive | 225 - 272 |
| Spugnette per trucco | 515 |
| Squadre | 305~306 - 309 - 316~317 |
| Staccionate | 688 - 693~694 |
| Stagioni della quercia | 508 |
| Stamperelli | 48 |
| Stampi a rilievo | 128~132 - 231 - 242 |
| Stampi in acciaio | 80 - 124 |
| Stampini | 78~81 - 290 |
| Stazione | 365 |
| Stearina | 230 |
| Stecche a incastro | 350 |
| Stecche per legatoria | 23 |
| Stecche per modellare | 135 |
| Stecche personaggi | 153 |
| Stelle autoadesive | 244 |
| Stelle filanti | 255 |
| Stelline | 201 |
| Stencil | 82~83 - 218 |

| | |
|----------------------------|-------------------|
| Stendibiancheria | 504 |
| Stick colla a caldo | 273 |
| Stick legno | 184~185 - 207 |
| Stickers | 249~253 |
| Stoffe | 92 - 192 - 238 |
| Stoppini | 230 |
| Stoviglie gioco | 494~496 |
| Strade adesive | 372 |
| Stringhe | 208 |
| Strofinacci | 326 |
| Strumenti musicali | 519~523 |
| Stucco | 126 |
| Stuoie | 556 |
| Sughero | 177~180 |
| Suncatcher | 165 |
| Supporti | 149~166 - 178~186 |
| da decorare | 226~227 - 246~247 |
| Supporti per dispenser gel | 696 |

T

| | |
|----------------------------|---------------------------|
| Tabelline | 459 |
| Tabellone ABC | 432 |
| Tagliacampioni | 282 |
| Tagliacarte | 290 |
| Taglieri | 150 |
| Taglierine | 44 - 284 |
| Tamburi e tamburelli | 520 |
| Tamponi per carteggiatura | 233 |
| Tamponi per pittura | 77 - 81 |
| Tane | 680~681 |
| Tangram | 451 |
| Tappeti | 554 - 556~566 - 689 - 698 |
| Tappeti gioco | 328 - 560~566 |
| Tappeti protettivi | 125 |
| Tappeto a pioli | 591 |
| Tappi per mattoni | 360 |
| Tappi sughero | 180 |
| Targhette portachiavi | 291 |
| Tatami | 554 |
| Tavola del tempo | 450 |
| Tavole forate per chiodini | 441~442 |
| Tavole in legno | 149 - 151~152 - 226 |
| Tavole magnetiche | 412 |
| Tavole per numerazione | 461 |
| Tavole per pregrafismi | 429~432 |
| Tavole predisegnate | 228 - 239 |
| Tavole sensoriali | 339 - 342~343 |
| Tavole smerigliate | 431 |
| Tavolette dei colori | 449 |
| Tavolette linoleum | 214 |
| Tavoli e tavolini | 635~639 |
| Tavoli luminosi | 219 |
| Tavoli multiuso | 666 |
| Tavoli pittura | 84 |
| Tavolo da gioco | 366 |
| Tavolo per coltivazioni | 481 |
| Tavolozze | 95~99 |
| Tazzine gioco | 494~496 |
| Teatrino | 435 - 500 - 517~518 |
| Tegole | 160 |
| Tekel adesivo | 220 |
| Teknitak | 302 |
| Tela juta | 175 |
| Telai | 92 - 189 - 193 - 237 |
| Tele per pittura | 93~94 |
| Teli isolanti | 323 |
| Teli per brandine | 658 - 661 |
| Teli ritmici | 594 |
| Tempera per incisioni | 87 |
| Temperamatite | 269~270 |
| Tempere | 62~64 - 67 - 87 - 104~105 |
| Tenaglia | 229 |
| Tennis | 608 |
| Termometri | 473 |
| Termotrafo | 228 |
| Terra | 258 |
| Terracotta da decorare | 160 |
| Tessere mosaico | 239~242 |
| Tessuti | 92 - 192 - 238 |
| Tessuto non tessuto | 174 |
| Test dello specchio | 489 |
| Teste per pupazzi | 148 - 181 - 184 |
| Texture domino | 340 |

| | |
|----------------|--|
| Timbri ufficio | 290 |
| Timbrini | 78~81 - 290 |
| Tombola | 340 - 391 - 393 - 395~396 425 - 448~449 |

| | |
|-------------------------|----------------------|
| Tondini legno | 226 |
| Torba | 481 |
| Torchio | 216 |
| Tornio | 136 |
| Torri impilabili | 333~337 - 451 |
| Torta di compleanno | 497 |
| Tovaglie e tovagliette | 262 |
| Tovaglioli | 222~223 - 262 |
| Trafile | 123 - 135 |
| Trafo | 228~229 |
| Trainabili | 329 - 331 |
| Trametti | 354 |
| Trampoli | 575~576 |
| Trapanetto | 229 |
| Trattore | 334 - 616 |
| Treccia in filato | 209 |
| Trenini e accessori | 363~368 - 372 - 375 |
| Trespoli per rifiuti | 297 |
| Trespoli scultura | 136 |
| Triangoli musicali | 522 |
| Triangolo multiattività | 332 |
| Tricicli | 617 |
| Tronchesino | 235 |
| Trottola | 329 |
| Trucchi | 255 - 514~515 |
| Truciolo | 248 - 318 |
| Tubetti | 19 - 209 - 354 - 477 |
| Tube portadisegni | 38 - 304 |
| Tubolari per uova | 147 |
| Tunnel motori | 595 - 613 |
| Tunnel per trenini | 367 |
| Turbopannello | 228 - 238 - 304 |

U

| | |
|--------------------|-------------------|
| Umehatrici | 290 |
| Uova da decorare | 140~142 - 146~147 |
| Uova musicali | 520 |
| Utensili da cucina | 494~496 |

V-W

| | |
|---------------------------|---|
| Vagoni | 368 - 375 |
| Valigetta dei giochi | 394 |
| Valigetta del dottore | 503 |
| Valigetta scrapbooking | 44 |
| Valigette portadisegni | 38 |
| Valigette primo soccorso | 325 |
| Vaschette | 199 - 260 - 453 |
| Vasetti | 150~151 - 160~161 - 480~483 |
| Vassoi | 150 - 199 - 260 |
| Veicoli | 371 - 373~376 |
| Velcro | 272 |
| Vernice magnetica lavagna | 87 |
| Vernici e spray | 59 - 88~89 - 113 126 - 201 - 224 - 255 - 259 - 276 |
| Vernideco e Verniacqua | 88 - 126 |
| Vetrini plastici | 141- 163 - 165 |
| Villaggio degli indiani | 386 |
| Vita nell'acqua | 485 |
| Viti e bulloni | 349 |
| Viti sepolte | 293 |
| Volano | 605 |
| Volley | 605 |
| Washi tape | 192 |
| Window foil | 164 |
| Wire-wire | 234 |

Z

| | |
|--------------|-----------|
| Zainetti | 166 - 297 |
| Zampette | 187 |
| Zanzariere | 662 |
| Zanzibar set | 433 |
| Zucche | 139 |

Indice per codice

| | | | | | | | | | | | | | | | |
|-----------|---------|----------|---------|----------|---------|---------|---------|-------|---------|----------|---------|---------|---------|----------|---------|
| 00510 | 230 | 04180 | 49 | 04402 | 218 | 04718 | 410 | 04918 | 247-321 | 05121 | 18 | 05385 | 270 | 05571 | 222 |
| 01040X48 | 160 | 04181 | 49 | 04404 | 235 | 04721 | 410 | 04919 | 247-321 | 05122 | 18 | 05386 | 291 | 05573 | 222 |
| 01050X48 | 160 | 04182 | 49 | 04405 | 220 | 04723 | 410 | 04922 | 109 | 05123 | 18 | 05387 | 291 | 05580 | 235 |
| 01090X36 | 160 | 04183 | 49 | 04406 | 220 | 04724 | 410 | 04925 | 28 | 05124 | 18 | 05388 | 291 | 05581 | 235 |
| 02001 | 105 | 04184 | 49 | 04407 | 220 | 04725 | 410 | 04926 | 28 | 05125 | 18 | 05389 | 291 | 05582 | 235 |
| 03567 | 127 | 04185 | 49 | 04410 | 83 | 04728 | 448 | 04928 | 231 | 05126 | 18 | 05395 | 285 | 05583 | 235 |
| 03578 | 284 | 04190 | 30 | 04411 | 83 | 04729 | 448 | 04929 | 231 | 05166X20 | 141 | 05396 | 28 | 05584 | 236 |
| 03579 | 284 | 04191 | 140 | 04413 | 83 | 04730 | 340 | 04930 | 231 | 05169 | 295 | 05397 | 203 | 05585 | 201 |
| 03583 | 218 | 04193X3 | 140 | 04414 | 83 | 04731 | 444 | 04931 | 231 | 05173X8 | 139 | 05398 | 203 | 05586 | 201 |
| 03589 | 300 | 04194X3 | 140 | 04415 | 83 | 04732 | 445 | 04933 | 231 | 05174X5 | 139 | 05399 | 203 | 05587 | 198 |
| 03597 | 253 | 04195X20 | 140 | 04416 | 83 | 04733 | 445 | 04934 | 231 | 05175 | 563 | 05400 | 203 | 05588 | 268 |
| 03598 | 253 | 04196X20 | 140 | 04417 | 83 | 04738 | 438 | 04935 | 231 | 05177 | 274 | 05401 | 203 | 05589 | 268 |
| 03599 | 253 | 04197X12 | 141 | 04429 | 230 | 04741 | 344 | 04936 | 231 | 05178 | 274 | 05402 | 203 | 05590 | 268 |
| 03600 | 253 | 04198X12 | 141 | 04430 | 230 | 04742 | 344 | 04937 | 231 | 05179 | 274 | 05403 | 203 | 05592 | 80 |
| 03602 | 253 | 04199X12 | 141 | 04431 | 230 | 04744 | 344 | 04941 | 247-321 | 05188 | 498 | 05404 | 203 | 05599 | 80 |
| 03604 | 253 | 04200X12 | 141 | 04432 | 230 | 04745 | 15 | 04942 | 659 | 05189 | 498 | 05406 | 11 | 05600 | 80 |
| 03606 | 253 | 04201X3 | 140 | 04435 | 131 | 04747 | 344-444 | 04944 | 219 | 05214 | 146 | 05407 | 14 | 05601 | 80 |
| 03607 | 253 | 04202X3 | 140 | 04436 | 231 | 04754 | 167 | 04948 | 230 | 05216 | 31 | 05408 | 177 | 05610 | 692 |
| 03608 | 253 | 04217 | 105 | 04438 | 231 | 04755 | 167 | 04949 | 230 | 05220 | 21 | 05409 | 177 | 05611 | 225 |
| 03609 | 253 | 04218 | 110 | 04439 | 231 | 04756 | 585 | 04954 | 587 | 05224 | 116 | 05410 | 150 | 05613 | 282 |
| 03610 | 253 | 04234 | 218 | 04444 | 230 | 04757 | 585 | 04956 | 96 | 05245 | 146 | 05411 | 150 | 05614 | 291 |
| 03617 | 488 | 04235 | 218 | 04445 | 230 | 04758 | 584 | 04958 | 86 | 05246 | 146 | 05413 | 150 | 05615 | 131-512 |
| 03618 | 177 | 04236 | 218 | 04490X50 | 266 | 04759 | 572 | 04960 | 572 | 05247 | 147 | 05414 | 150 | 05616 | 512 |
| 03620 | 81 | 04238 | 218 | 04491X50 | 266 | 04760 | 573 | 04961 | 360-583 | 05248 | 146 | 05415 | 114-151 | 05617 | 131-512 |
| 03621 | 81 | 04255 | 83 | 04492X50 | 266 | 04761 | 573 | 04962 | 109 | 05249 | 207 | 05418 | 283 | 05618 | 131-512 |
| 03622 | 81 | 04262 | 32 | 04493X24 | 269 | 04762 | 567 | 04965 | 23 | 05251X12 | 141 | 05419 | 283 | 05619 | 131-512 |
| 03623 | 81 | 04266 | 124 | 04527 | 131 | 04763 | 573 | 04966 | 23 | 05252X10 | 141 | 05433 | 30 | 05623 | 7 |
| 03624 | 81 | 04267 | 80 | 04528 | 131 | 04764 | 573 | 04967 | 23 | 05253 | 547-548 | 05434 | 15 | 05624 | 7 |
| 03625 | 81 | 04268 | 80 | 04542 | 115 | 04768 | 13 | 04968 | 23 | 05254 | 547 | 05437 | 78 | 05625 | 7 |
| 03626 | 81 | 04269 | 80 | 04543 | 115 | 04772 | 222 | 04969 | 23 | 05257 | 550 | 05438 | 78 | 05626 | 7 |
| 03628 | 81 | 04271 | 231 | 04544 | 115 | 04775 | 211 | 04970 | 23 | 05259 | 550 | 05439 | 78 | 05627 | 7 |
| 03629 | 169 | 04272 | 231 | 04547 | 95 | 04779 | 342 | 04972 | 35 | 05260 | 541 | 05441 | 109 | 05628 | 7 |
| 03631 | 171 | 04273 | 231 | 04548 | 95 | 04782 | 351 | 04974 | 33 | 05261 | 541 | 05443 | 242 | 05629 | 7 |
| 03634 | 467 | 04274 | 231 | 04550 | 268 | 04783 | 439 | 04986 | 132 | 05262 | 541 | 05447 | 623 | 05630 | 7 |
| 03635 | 347 | 04275 | 231 | 04551 | 229 | 04785 | 360-583 | 04989 | 132 | 05263 | 541 | 05448 | 70 | 05632 | 80 |
| 03643 | 213-218 | 04276 | 231 | 04552 | 215-229 | 04786 | 586 | 04990 | 132 | 05265 | 537-541 | 05449 | 218 | 05633X4 | 80 |
| 03644 | 213-218 | 04277 | 231 | 04553X12 | 77 | 04788 | 360-583 | 04991 | 132 | 05266 | 541 | 05456 | 218 | 05634 | 80 |
| 03645 | 213-218 | 04278 | 231 | 04554X12 | 77 | 04799 | 260 | 04992 | 132 | 05267 | 541 | 05458 | 218 | 05635 | 80 |
| 03646 | 135 | 04287 | 230 | 04555 | 76 | 04800 | 261 | 04996 | 132 | 05269 | 541 | 05459 | 218 | 05636 | 231 |
| 03647 | 135 | 04288 | 230 | 04556 | 76 | 04801 | 260 | 04998 | 132 | 05271 | 543 | 05460 | 218 | 05637X12 | 139 |
| 03652 | 242 | 04291 | 230 | 04557 | 268 | 04802 | 260-453 | 05000 | 132 | 05272 | 543 | 05461 | 218 | 05638X6 | 139 |
| 03655 | 247-321 | 04292 | 230 | 04571 | 231 | 04808 | 23 | 05003 | 177 | 05274 | 537 | 05462 | 479 | 05639X5 | 140 |
| 03656 | 247-321 | 04293 | 230 | 04572 | 231 | 04812 | 223 | 05012 | 123 | 05275 | 537 | 05465 | 475 | 05640X4 | 140 |
| 03657 | 247-321 | 04294 | 230 | 04591 | 230 | 04815 | 224 | 05016 | 76 | 05276 | 541 | 05466 | 474 | 05641X4 | 140 |
| 03658 | 247-321 | 04295 | 230 | 04598 | 164 | 04816 | 224 | 05019 | 81 | 05277 | 537 | 05467 | 475 | 05642X5 | 140 |
| 03659 | 247-321 | 04307 | 123 | 04612 | 228 | 04820 | 224-276 | 05020 | 81 | 05278 | 537 | 05468 | 475 | 05643X3 | 140 |
| 03660 | 247-321 | 04309 | 124 | 04613 | 228 | 04821 | 224-276 | 05021 | 80-171 | 05279 | 537 | 05470 | 355 | 05644X3 | 140 |
| 03661 | 247-321 | 04319 | 282 | 04616 | 215-229 | 04826 | 40 | 05023 | 80-171 | 05280 | 537 | 05473 | 103 | 05645X5 | 140 |
| 03662 | 247-321 | 04320 | 282 | 04620 | 83 | 04827 | 40 | 05024 | 80-171 | 05281 | 537 | 05474X5 | 206 | 05648X4 | 141 |
| 03663 | 247-321 | 04321 | 282 | 04621 | 83 | 04829 | 40 | 05025 | 80-171 | 05282 | 541 | 05475X5 | 206 | 05649X3 | 140 |
| 03664 | 247-321 | 04322X4 | 169 | 04647X12 | 164 | 04830 | 40 | 05026 | 80-171 | 05289 | 591 | 05476X5 | 206 | 05650X4 | 140 |
| 03691 | 71 | 04323X4 | 169 | 04648X12 | 164 | 04831 | 40 | 05027 | 80-171 | 05302 | 231 | 05477X5 | 206 | 05651X10 | 140 |
| 03692 | 71 | 04324X4 | 169 | 04649X12 | 164 | 04832 | 40 | 05028 | 80-171 | 05306 | 270 | 05478X5 | 206 | 05652 | 215-229 |
| 03693 | 71 | 04325X4 | 169 | 04650X12 | 164 | 04833 | 40 | 05029 | 80-171 | 05307X4 | 611 | 05479 | 241 | 05656 | 242 |
| 03694 | 71 | 04326X4 | 169 | 04656 | 164 | 04834 | 40 | 05030 | 80-171 | 05310 | 10 | 05494 | 157-512 | 05657 | 156 |
| 03738 | 78 | 04327X4 | 169 | 04657 | 164 | 04840 | 15 | 05031 | 201 | 05311 | 10 | 05496 | 224-283 | 05658 | 132 |
| 03742 | 169 | 04328X4 | 169 | 04658 | 211 | 04841 | 31 | 05034 | 201 | 05312 | 10 | 05497 | 157-517 | 05662 | 132 |
| 03782 | 300 | 04329X4 | 169 | 04659 | 211 | 04842 | 14 | 05041 | 502 | 05313 | 10 | 05498 | 283 | 05663 | 132 |
| 03804 | 135 | 04330X4 | 169 | 04660 | 211 | 04843 | 15 | 05050 | 502 | 05314 | 10 | 05499 | 103 | 05664 | 132 |
| 03816 | 219 | 04331X4 | 169 | 04661 | 211 | 04844 | 658 | 05051 | 502 | 05315 | 10 | 05507 | 645 | 05665 | 132 |
| 03861/1 | 218 | 04332 | 73 | 04662 | 211 | 04845 | 235 | 05052 | 502 | 05316 | 10 | 05508 | 645 | 05666 | 132 |
| 03861/2 | 218 | 04333 | 73 | 04663 | 211 | 04849 | 221 | 05054 | 512 | 05317 | 10 | 05509 | 297 | 05667 | 132 |
| 03861/4 | 218 | 04334 | 217 | 04664 | 211 | 04851 | 221 | 05060 | 75 | 05318 | 10 | 05510 | 645 | 05668 | 132 |
| 03861/5 | 218 | 04335 | 217 | 04665 | 211 | 04862 | 221 | 05065 | 80 | 05319 | 10 | 05511 | 612-645 | 05670 | 132 |
| 03861/6 | 218 | 04336 | 164 | 04666 | 211 | 04864 | 221 | 05075 | 123 | 05320 | 10 | 05512 | 477 | 05673 | 132 |
| 03871/1 | 218 | 04337 | 76 | 04667 | 211 | 04866 | 221 | 05076 | 123 | 05321 | 10 | 05513 | 478 | 05674 | 132 |
| 03871/2 | 218 | 04339 | 230 | 04668 | 164 | 04867 | 221 | 05085 | 658 | 05322 | 10 | 05514 | 297 | 05678 | 132 |
| 03871/3 | 218 | 04340 | 230 | 04669 | 99 | 04869 | 221 | 05086 | 42 | 05323 | 10 | 05515 | 297 | 05679 | 132 |
| 03871/4 | 218 | 04341 | 238-294 | 04670 | 99 | 04880 | 224-283 | 05088 | 42 | 05329 | 96 | 05517 | 488 | 05680 | 2-243 |
| 03871/5 | 218 | 04342 | 294 | 04671 | 99 | 04884 | 225 | 05093 | 286 | 05330 | 202 | 05518 | 155 | 05690 | 260-496 |
| 03871/6 | 218 | 04343 | 238-294 | 04673 | 487 | 04885 | 225 | 05097 | 586 | 05336 | 290 | 05528 | 253 | 05695 | 127 |
| 03881/ASS | 82 | 04344 | 294 | 04679 | 337 | 04886 | 225 | 05098 | 659 | 05337 | 290 | 05529 | 253 | 05696 | 127 |
| 03919x12 | 146 | 04369 | 28 | 04680 | 337 | 04887x5 | 179 | 05099 | 660 | 05338 | 290 | 05534/6 | 80 | 05697 | 127 |
| 03921 | 127 | 04370 | 28 | 04683 | 337 | 04888x5 | 179 | 05100 | 18 | 05340 | 290 | 05537 | 450 | 05698 | 127 |
| 03965 | 162 | 04371 | 28 | 04687 | 428 | 04889x5 | 179 | 05101 | 18 | 05341 | 290 | 05538 | 437 | 05699x9 | 180 |
| 03966 | 162 | 04372 | 28 | 04688 | 428 | 04890x5 | 179 | 05102 | 18 | 05345 | 146 | 05541 | 175 | 05700x6 | 180 |
| 03967 | 162 | 04373 | 28 | 04689 | 324-428 | 04891x5 | 179 | 05103 | 18 | 05346 | 288 | 05547 | 251 | 05702 | 612 |
| 03968 | 162 | 04374 | 154 | 04691 | 340 | 04892x5 | 179 | 05104 | 18 | 05347 | 268 | 05548 | 252 | 05703 | 6-243 |
| 03969X6 | 163 | 04390 | 233 | 04694 | 406 | 04893x5 | 179 | 05105 | 18 | 05348X6 | 165 | 05550 | 250 | 05705 | 221 |
| 03970X6 | 163 | 04391 | 233 | 04697 | 447 | 04894x5 | 179 | 05106 | 18 | 05349X6 | 165 | 05552 | 251 | 05722 | 221 |
| 04140 | 71 | 04392 | 233 | 04698 | 447 | 04895 | 151 | 05107 | 18 | 05350 | 165 | 05554 | 155 | 05734 | |

| | | | | | | | | | | | | | | | |
|---------|-----|-----------|---------|------------|---------|-----------|---------|----------|---------|---------|---------|----------|---------|----------|-----|
| 05752 | 122 | 05926 | 239 | 06120 | 239 | 06305 | 234 | 06571 | 205 | 06853 | 237 | 07067 | 198 | 07321 | 513 |
| 05755 | 190 | 05927 | 239 | 06121X6 | 23 | 06306 | 234 | 06587 | 148 | 06854 | 237 | 07068 | 198 | 07322 | 513 |
| 05756 | 190 | 05928 | 239 | 06125 | 300 | 06307 | 181 | 06588 | 148 | 06861 | 221 | 07069 | 198 | 07323 | 513 |
| 05757 | 464 | 05929 | 239 | 06127 | 58 | 06308 | 32 | 06589 | 148 | 06863 | 221 | 07070 | 198 | 07324 | 513 |
| 05758 | 345 | 05930 | 239 | 06128 | 60 | 06309 | 234 | 06590 | 146 | 06865 | 221 | 07071 | 198 | 07325 | 513 |
| 05759 | 469 | 05931 | 239 | 06129 | 264 | 06310 | 658 | 06596 | 692 | 06876 | 223 | 07072 | 198 | 07337x6 | 147 |
| 05762 | 162 | 05932 | 239 | 06130 | 264 | 06311 | 659 | 06597 | 114 | 06877 | 223 | 07073 | 198 | 07338 | 252 |
| 05769 | 321 | 05934 | 239 | 06131 | 264 | 06312 | 659 | 06598 | 114 | 06878 | 223 | 07074 | 198 | 07340 | 252 |
| 05770 | 321 | 05935 | 239 | 06135 | 50-265 | 06313 | 659 | 06600 | 692 | 06880 | 152 | 07075 | 198 | 07345 | 245 |
| 05771 | 321 | 05936 | 239 | 06136 | 50-265 | 06315 | 660 | 06605 | 658 | 06881 | 152 | 07076 | 198 | 07346 | 245 |
| 05773 | 323 | 05937 | 239 | 06137 | 50-265 | 06316 | 235 | 06606 | 658 | 06882 | 284 | 07077 | 182 | 07347 | 245 |
| 05776 | 380 | 05938 | 239 | 06138 | 50-265 | 06317 | 235 | 06608 | 566 | 06885 | 284 | 07078 | 182 | 07348 | 245 |
| 05777 | 380 | 05939 | 239 | 06141 | 300 | 06318 | 235 | 06617 | 223 | 06886 | 284 | 07079 | 182 | 07350 | 245 |
| 05778 | 380 | 05940 | 239 | 06142 | 300 | 06335 | 151 | 06624 | 223 | 06890 | 221 | 07084 | 688 | 07351 | 245 |
| 05779 | 380 | 05941 | 239 | 06145 | 137 | 06336 | 151 | 06640 | 75 | 06893 | 221 | 07086 | 641 | 07352 | 245 |
| 05780 | 380 | 05942 | 239 | 06152 | 31 | 06337 | 151 | 06642 | 111 | 06894 | 221 | 07097 | 151 | 07354 | 245 |
| 05786 | 276 | 05943 | 239 | 06153 | 70 | 0634/O4 | 226 | 06643 | 111 | 06895 | 221 | 07099 | 234 | 07361 | 610 |
| 05787 | 276 | 05944 | 239 | 06155X10 | 125 | 0634/2 | 226 | 06644 | 111 | 06904 | 151 | 07100 | 180 | 07362 | 610 |
| 05788 | 276 | 05945 | 239 | 06156X10 | 125 | 0634/4 | 226 | 06646 | 73 | 06916 | 415 | 07101 | 169 | 07366 | 613 |
| 05790 | 276 | 05947 | 32 | 06164 | 273 | 06340 | 150 | 06649 | 73 | 06917 | 353 | 07103x6 | 247 | 07371 | 595 |
| 05797 | 175 | 05948 | 32 | 06165 | 273 | 06341 | 150 | 06650 | 73 | 06926 | 237 | 07104 | 526 | 07372 | 595 |
| 05804 | 14 | 05949 | 32 | 06165/1000 | 273 | 06342x4 | 150 | 06652 | 206 | 06927 | 237 | 07106 | 2-243 | 07373 | 526 |
| 05811 | 479 | 05950 | 32 | 06169 | 297 | 06343x2 | 150 | 06653 | 111 | 06930X5 | 442 | 07107 | 2-243 | 07374 | 526 |
| 05812 | 478 | 05951 | 31 | 06171 | 526 | 06344 | 198-235 | 06654 | 73 | 06933 | 422 | 07108 | 2-243 | 07375 | 201 |
| 05813 | 475 | 05952 | 31 | 06172 | 526 | 06345 | 220 | 06655/1 | 202 | 06934 | 341 | 07109 | 178 | 07376 | 201 |
| 05814 | 474 | 05953 | 15 | 06174 | 526 | 0635/2X12 | 226 | 06656/1 | 202 | 06935 | 469 | 07110 | 178 | 07377 | 201 |
| 05815 | 475 | 05954 | 15 | 06175 | 526 | 0635/4X6 | 226 | 06657/1 | 202 | 06938 | 458 | 07111 | 180 | 07384 | 59 |
| 05816 | 439 | 05955 | 15 | 06180 | 526 | 0635/6X6 | 226 | 06658 | 282 | 06939 | 457 | 07115 | 195 | 07385 | 59 |
| 05818 | 350 | 05956 | 15 | 06185 | 262 | 06370 | 151 | 06659 | 282 | 06950 | 454 | 07119 | 209 | 07386 | 59 |
| 05819 | 205 | 05957 | 150 | 06186 | 262 | 06371 | 151 | 06700 | 7 | 06955 | 414 | 07120 | 209 | 07387 | 432 |
| 05820 | 205 | 05958 | 150 | 06187 | 262 | 06372 | 150 | 06701 | 7 | 06956 | 414 | 07121 | 209 | 07388 | 244 |
| 05821 | 205 | 05959 | 150 | 06202 | 239 | 06377 | 446 | 06702 | 7 | 06960 | 560 | 07122 | 208 | 07389 | 244 |
| 05822 | 205 | 05960 | 150 | 06203 | 239 | 06378 | 406 | 06703 | 7 | 06962 | 86 | 07123 | 225-320 | 07390 | 244 |
| 05823 | 205 | 05961 | 150 | 06204 | 239 | 06383X6 | 182 | 06704 | 7 | 06963 | 237 | 07126 | 125-287 | 07391 | 244 |
| 05824 | 205 | 05962 | 151 | 06205 | 239 | 06384X6 | 182 | 06705 | 7 | 06966 | 465 | 07128 | 125-287 | 07392 | 244 |
| 05825 | 205 | 05963 | 150 | 06217 | 526 | 06385X6 | 182 | 06706 | 7 | 06967 | 465 | 07129 | 125 | 07393 | 244 |
| 05826 | 205 | 05964 | 151 | 06218 | 526 | 06386 | 182 | 06707 | 7 | 06968 | 341 | 07130 | 125 | 07394 | 244 |
| 05827 | 205 | 05972x50 | 291 | 06219 | 215-217 | 06387X6 | 182 | 06708 | 23 | 06969 | 338 | 07143 | 30 | 07395 | 244 |
| 05828 | 205 | 05973x50 | 291 | 06220 | 101-260 | 06389X6 | 182 | 06710 | 260 | 06970 | 49-160 | 07145 | 178 | 07396 | 244 |
| 05829 | 205 | 05974x100 | 291 | 06226 | 71 | 06390X6 | 182 | 06714 | 88 | 06971 | 49-160 | 07147 | 224 | 07397 | 244 |
| 05830 | 205 | 05977x25 | 291 | 06227 | 71 | 06391X6 | 182 | 06723 | 203 | 06972 | 49-160 | 07150 | 81 | 07398 | 244 |
| 05831 | 205 | 05978 | 279 | 06228 | 71 | 06392 | 521 | 06726/N | 415 | 06973 | 49-160 | 07151 | 148-259 | 07399 | 244 |
| 05832 | 205 | 05981 | 303 | 06229 | 71 | 06393 | 521 | 06729 | 177 | 06974 | 49-160 | 07152 | 488 | 07400 | 244 |
| 05833 | 205 | 06004 | 93 | 06230 | 71 | 06394 | 521 | 06731 | 152 | 06975 | 49-160 | 07153x6 | 178 | 07402 | 244 |
| 05835 | 205 | 06005 | 93 | 06231 | 71 | 06395 | 521 | 06736 | 242 | 06978 | 124 | 07154x6 | 178 | 07403 | 244 |
| 05836 | 205 | 06006 | 93 | 06232 | 71 | 06396 | 520 | 06738 | 242 | 06980 | 49-161 | 07155x6 | 178 | 07404 | 244 |
| 05837 | 205 | 06007 | 93 | 06234X6 | 141 | 06397 | 520 | 06739 | 242 | 06981 | 49-161 | 07156x10 | 178 | 07405 | 244 |
| 05838 | 205 | 06008 | 93 | 06235X10 | 141 | 06400 | 521 | 06742 | 242 | 06982 | 49-161 | 07157 | 178 | 07406 | 244 |
| 05839 | 205 | 06009 | 93 | 06239 | 239 | 06401 | 521 | 06743 | 242 | 06983 | 49-161 | 07158 | 178 | 07407 | 244 |
| 05840 | 205 | 0601/1X10 | 226 | 06240 | 239 | 06402 | 521 | 06752 | 220 | 06984 | 49-161 | 07159 | 489 | 07408 | 244 |
| 05841 | 205 | 0601/2X10 | 226 | 06242 | 222 | 06403 | 521 | 06753 | 220 | 06985 | 49-161 | 07161x6 | 181 | 07409 | 244 |
| 05842 | 205 | 0601/4X4 | 226 | 06244X3 | 222 | 06405 | 522 | 06755 | 220 | 06986 | 653 | 07162x6 | 148 | 07410 | 244 |
| 05844 | 205 | 0601/6X4 | 226 | 06245 | 222 | 06406 | 522 | 06756 | 220 | 06987 | 152 | 07163 | 684 | 07411 | 244 |
| 05845 | 205 | 06010 | 93 | 06246 | 222 | 06408 | 520 | 06757 | 220 | 06989 | 528 | 07164 | 684 | 07412 | 244 |
| 05846 | 205 | 06017 | 68 | 06247 | 222 | 06409 | 520 | 06758 | 220 | 06990 | 530 | 07165 | 488 | 07413 | 244 |
| 05847 | 205 | 06018 | 82 | 06248 | 222 | 06410 | 522 | 06760 | 178 | 06991 | 530 | 07166 | 431 | 07414 | 244 |
| 05849 | 205 | 06019 | 82 | 06253 | 526 | 06411 | 522 | 06761 | 178 | 06992 | 530 | 07168 | 431 | 07415 | 244 |
| 05850 | 205 | 06020 | 82 | 06254 | 526 | 06412 | 520 | 06762 | 178 | 06993 | 530 | 07169 | 177 | 07420 | 19 |
| 05851 | 205 | 06021 | 82 | 06255 | 526 | 06414 | 520 | 06765 | 73 | 06994 | 530 | 07184 | 9 | 07421 | 19 |
| 05852 | 205 | 06022 | 100 | 06258 | 526 | 06415 | 520 | 06767 | 204 | 06995 | 530 | 07185 | 9 | 07422 | 19 |
| 05853 | 205 | 06023 | 69 | 06259 | 526 | 06416 | 523 | 06769 | 276 | 06996 | 530 | 07186 | 9 | 07423 | 19 |
| 05855 | 242 | 06024 | 100 | 06260 | 164 | 06421 | 260 | 06770 | 561 | 06997 | 530 | 07187 | 9 | 07424 | 19 |
| 05858X6 | 141 | 06026 | 283 | 06262 | 3 | 06422 | 235 | 06771 | 561 | 07007 | 126-224 | 07188 | 9 | 07425 | 19 |
| 05859 | 181 | 06027 | 283 | 06263 | 3 | 06423 | 235 | 06772 | 561 | 07018 | 507 | 07190 | 9 | 07426 | 19 |
| 05860 | 181 | 06028 | 77 | 06264 | 3 | 06424 | 235 | 06773 | 689 | 07019 | 507 | 07191 | 9 | 07427 | 19 |
| 05861 | 181 | 06029 | 77 | 06266 | 30 | 06425 | 484 | 06774 | 689 | 07020 | 119 | 07192 | 9 | 07428 | 19 |
| 05862 | 181 | 06030 | 77 | 06267 | 30 | 06429 | 361 | 06778 | 220 | 07021 | 119 | 07193 | 9 | 07429 | 19 |
| 05863 | 181 | 06039 | 27 | 06274 | 24 | 06430 | 361 | 06787 | 233 | 07022 | 119 | 07195 | 262 | 07430 | 19 |
| 05864 | 181 | 0605/2 | 226 | 06275 | 24 | 06444 | 328 | 06788 | 233 | 07023 | 119 | 07196 | 6 | 07431 | 19 |
| 05865 | 181 | 0605/3 | 226 | 06276 | 35 | 06447 | 234 | 06809 | 422 | 07024 | 119 | 07197 | 6 | 07432 | 19 |
| 05866 | 181 | 06051 | 100 | 06277 | 35 | 06452 | 6 | 06811 | 222 | 07025 | 119 | 07200 | 221 | 07433 | 34 |
| 05867 | 181 | 06056 | 15 | 06278 | 35 | 06454 | 224 | 06812 | 222 | 07026 | 119 | 07201 | 165 | 07440 | 124 |
| 05868 | 182 | 06057X6 | 141 | 06279 | 35 | 06456 | 93 | 06813 | 222 | 07027 | 119 | 07214 | 165 | 07442 | 124 |
| 05869 | 182 | 06058X10 | 141 | 06280 | 35 | 06457 | 93 | 06814 | 500 | 07028 | 119 | 07215 | 165 | 07443 | 124 |
| 05870 | 182 | 06068 | 248-318 | 06458 | 234 | 06458 | 93 | 06815 | 518 | 07029 | 119 | 07216X4 | 451 | 07444 | 124 |
| 05871 | 182 | 06069 | 16 | 06282X10 | 31 | 06460 | 526 | 06816 | 674 | 07030 | 119 | 07232 | 205 | 07445 | 124 |
| 05872 | 182 | 06080 | 260 | 06283X10 | 31 | 06467 | 454 | 06817 | 245 | 07031 | 119 | 07233 | 205 | 07447 | 124 |
| 05873 | 182 | 06088 | 285 | 06284X10 | 31 | 06468 | 272 | 06818 | 195 | 07032 | 119 | 07234 | 205 | 07450x10 | 247 |
| 05879 | 272 | 06089 | 13 | 06285X10 | 31 | 06497 | 207-322 | 06819 | 195 | 07033 | 119 | 07235 | 205 | 07451x10 | 247 |
| 05882 | 200 | 06094X8 | 144 | 06286X10 | 31 | 06500 | 235 | 06820 | 346-433 | 07040 | 120 | 07240 | 234 | 07452x10 | 247 |
| 05883 | 200 | 06095X5 | 144 | 06287X10 | 31 | 06504 | 235 | 06821 | 346-433 | 07043 | 120 | 07243X4 | 451 | 07453x10 | 247 |
| 05884 | 200 | 06096X5 | 143 | 06288 | 151-15 | 06505 | 235 | 06824 | 73 | 07049 | 604 | 07244 | 233 | 07454 | 245 |
| 05885 | 200 | 06097X8 | 143 | 06290 | 24 | 06506 | 235 | 06828X25 | 29 | | | | | | |

| | | | | | | | | | | | | | | | |
|----------|-----|---------|---------|----------|---------|-------|---------|-------|---------|-----------|---------|----------|---------|-----------|---------|
| 07481 | 126 | 07709 | 473 | 07879X11 | 143 | 08072 | 638 | 08194 | 623 | 08405X12 | 476 | 08667 | 173 | 08794/443 | 108 |
| 07482x5 | 149 | 07711 | 612 | 07880X6 | 143 | 08073 | 638 | 08195 | 623 | 08406X12 | 477 | 08668 | 173 | 08794/453 | 108 |
| 07483 | 149 | 07713 | 152-209 | 07887 | 40 | 08074 | 638 | 08196 | 272 | 08407X12 | 477 | 08669 | 173 | 08794/509 | 108 |
| 07484 | 149 | 07714 | 152 | 07888 | 40 | 08075 | 638 | 08197 | 272 | 08408X12 | 477 | 08670 | 173 | 08794/538 | 108 |
| 07485 | 149 | 07715x5 | 149 | 07891 | 649 | 08076 | 638 | 08198 | 208-235 | 08409X12 | 477 | 08671 | 206 | 08794/684 | 108 |
| 07486 | 149 | 07716X6 | 141 | 07892 | 649 | 08077 | 638 | 08199 | 477 | 08410X12 | 476 | 08672 | 206 | 08794/793 | 108 |
| 07487 | 149 | 07717X6 | 141 | 07893 | 489 | 08078 | 638 | 08201 | 477 | 08411X12 | 476 | 08673 | 206 | 08808/01 | 63 |
| 07488 | 546 | 07718x5 | 149 | 07894 | 42 | 08079 | 638 | 08202 | 32 | 08412X12 | 476 | 08674 | 206 | 08808/02 | 63 |
| 07490 | 586 | 07720 | 652 | 07895 | 42 | 08080 | 638 | 08203 | 32 | 08415X12 | 477 | 08675 | 93 | 08808/06 | 63 |
| 07491 | 232 | 07721 | 652 | 07896 | 42 | 08081 | 638 | 08209 | 527 | 08416X12 | 476 | 08676 | 93 | 08808/07 | 63 |
| 07492 | 232 | 07722 | 652 | 07905 | 649-651 | 08082 | 207 | 08210 | 527 | 08417 | 165 | 08677 | 38 | 08808/08 | 63 |
| 07493 | 232 | 07729 | 652 | 07908 | 455 | 08083 | 207 | 08211 | 527 | 08428 | 449 | 08678 | 38-598 | 08808/10 | 63 |
| 07494 | 232 | 07730 | 323 | 07919 | 433 | 08084 | 628 | 08212 | 527 | 08429X10 | 477 | 08679 | 630 | 08808/11 | 63 |
| 07495 | 232 | 07734 | 468 | 07920 | 241-433 | 08085 | 628 | 08213 | 527 | 08430 | 682 | 08680 | 590 | 08808/12 | 63 |
| 07496 | 494 | 07735 | 653 | 07921 | 655 | 08086 | 628 | 08215 | 527 | 08431 | 682 | 08681 | 590 | 08808/14 | 63 |
| 07515 | 508 | 07736 | 653 | 07926 | 652 | 08087 | 628 | 08217 | 527 | 08436 | 621 | 08686 | 340-589 | 08808/17 | 63 |
| 07519 | 508 | 07737 | 455 | 07932 | 7 | 08089 | 179 | 08218 | 527 | 08438 | 623 | 08687 | 340-589 | 08808/21 | 63 |
| 07529X10 | 320 | 07761 | 60 | 07933 | 7 | 08090 | 179 | 08219 | 527 | 08441 | 628 | 08688 | 340-589 | 08808/25 | 63 |
| 07530 | 68 | 07762 | 60 | 07934 | 7 | 08091 | 179 | 08221 | 238-527 | 08443 | 623 | 08689 | 340-589 | 08808/26 | 63 |
| 07531 | 68 | 07763 | 50-265 | 07969X5 | 142 | 08092 | 179 | 08223 | 527 | 08444 | 623 | 08691 | 340-589 | 08808/28 | 63 |
| 07532 | 68 | 07764 | 200 | 07970X2 | 142 | 08093 | 274 | 08224 | 527 | 08445 | 131-512 | 08693 | 588 | 08808/40 | 63 |
| 07533 | 68 | 07765 | 200 | 07971 | 37-650 | 08094 | 88 | 08228 | 527 | 08446 | 131-512 | 08694 | 588 | 08808/41 | 63 |
| 07534 | 68 | 07766 | 648 | 07972 | 18 | 08095 | 88 | 08229 | 527 | 08447 | 131-512 | 08695 | 588 | 08824 | 558 |
| 07535 | 68 | 07767 | 640-648 | 07973 | 18 | 08100 | 101-199 | 08231 | 527 | 08454 | 666 | 08696 | 588 | 08825 | 659 |
| 07536 | 101 | 07770 | 504 | 07974 | 18 | 08101 | 100-453 | 08232 | 527 | 08455 | 666 | 08697 | 588 | 08827 | 659 |
| 07543 | 430 | 07776 | 410 | 07975 | 18 | 08102 | 261-453 | 08235 | 227 | 08460 | 299 | 08698 | 340-589 | 08831X5 | 139 |
| 07560 | 463 | 07784 | 505 | 07976 | 304-671 | 08103 | 668 | 08236 | 227 | 08528 | 211 | 08699 | 340-589 | 08833 | 656 |
| 07561 | 149 | 07786 | 18 | 07977 | 304 | 08104 | 598-669 | 08237 | 227 | 08529 | 211 | 08701 | 630 | 08836 | 324 |
| 07562 | 149 | 07787 | 19 | 07978 | 304 | 08105 | 669 | 08238 | 227 | 08530 | 211 | 08703 | 630 | 08840 | 645 |
| 07563 | 149 | 07788 | 594 | 07979 | 304 | 08109 | 669 | 08239 | 227 | 08531 | 211 | 08704 | 590 | 08842 | 656 |
| 07564 | 149 | 07789 | 37-650 | 07980 | 304 | 08110 | 85-672 | 08240 | 227 | 08532 | 211 | 08707 | 37 | 08843 | 656 |
| 07565 | 149 | 07790 | 640 | 07984 | 282 | 08112 | 677 | 08241 | 227 | 08535 | 216 | 08708 | 37 | 08844 | 656 |
| 07566 | 149 | 07791 | 639 | 07990 | 6 | 08113 | 84-668 | 08242 | 227 | 08536 | 216 | 08709 | 37 | 08845 | 656 |
| 07567 | 149 | 07794 | 636 | 07991x4 | 700 | 08115 | 640 | 08243 | 227 | 08537 | 216 | 08710 | 37 | 08846 | 656 |
| 07568 | 149 | 07795 | 636 | 07992x4 | 578 | 08117 | 161 | 08244 | 227 | 08538 | 216 | 08711 | 557 | 08847 | 656 |
| 07569 | 149 | 07796 | 636 | 07993x4 | 578-700 | 08118 | 161 | 08245 | 227 | 08539 | 216 | 08712 | 557 | 08848 | 656 |
| 07570 | 149 | 07797 | 636 | 07994x4 | 578 | 08121 | 641 | 08246 | 227 | 08540 | 216 | 08713 | 557 | 08851 | 19 |
| 07571 | 149 | 07798 | 637 | 07996 | 283 | 08122 | 641 | 08247 | 227 | 08541 | 216 | 08714 | 557 | 08852 | 19 |
| 07572 | 149 | 07799 | 637 | 07997 | 226 | 08123 | 641 | 08251 | 692 | 08542 | 216 | 08715 | 625 | 08853 | 19 |
| 07573x5 | 149 | 07800 | 636 | 07998 | 226 | 08124 | 655 | 08252 | 692 | 08543 | 189 | 08719 | 173 | 08854 | 19 |
| 07574x5 | 149 | 07801 | 636 | 07999 | 226 | 08126 | 655 | 08253 | 692 | 08544 | 432 | 08721 | 338 | 08855 | 19 |
| 07575x5 | 149 | 07802 | 636 | 08000 | 126 | 08128 | 162 | 08257 | 328 | 08545 | 432 | 08724 | 232 | 08856 | 19 |
| 07577 | 320 | 07803 | 636 | 08002 | 126 | 08129 | 162 | 08288 | 479 | 08549 | 136 | 08727 | 581 | 08857 | 19 |
| 07582 | 314 | 07804 | 637 | 08003 | 126 | 08130 | 162 | 08299 | 8 | 08563 | 217 | 08728x2 | 581 | 08858 | 19 |
| 07584 | 315 | 07805 | 637 | 08004 | 126 | 08131 | 162 | 08300 | 8 | 08564 | 217 | 08729 | 558 | 08876 | 348 |
| 07587X12 | 141 | 07806 | 637 | 08005 | 126 | 08132 | 162 | 08301 | 8 | 08565 | 217 | 08730 | 558 | 08886 | 472 |
| 07588X12 | 141 | 07807 | 637 | 08006 | 126 | 08133 | 520 | 08302 | 8 | 08566x5 | 149 | 08731 | 558 | 08887 | 345-519 |
| 07590 | 196 | 07809 | 648 | 08007 | 126 | 08134 | 520 | 08303 | 8 | 08567x5 | 149 | 08732 | 558 | 08888 | 611 |
| 07592 | 196 | 07810 | 649 | 08009 | 312 | 08135 | 521 | 08304 | 8 | 08568x5 | 149 | 08738 | 567 | 08890X3 | 610 |
| 07593 | 196 | 07811 | 649 | 08010 | 312 | 08136 | 521 | 08305 | 8 | 08569x5 | 149 | 08739 | 567 | 08891 | 596 |
| 07594 | 196 | 07813 | 640 | 08011 | 315 | 08137 | 520 | 08306 | 8 | 08570 | 149 | 08744 | 511 | 08892/1x6 | 597 |
| 07595 | 196 | 07815 | 639 | 08012 | 315 | 08138 | 520 | 08307 | 8 | 08571 | 149 | 08746 | 589 | 08893 | 608 |
| 07599X10 | 207 | 07816 | 639 | 08013 | 315 | 08140 | 522 | 08308 | 8 | 08572 | 149 | 08747 | 589 | 08894 | 609 |
| 07600X10 | 155 | 07817 | 639 | 08014 | 315 | 08141 | 326-622 | 08309 | 8 | 08573 | 149 | 08748 | 593 | 08895 | 596 |
| 07601X10 | 155 | 07818 | 577 | 08015 | 125-287 | 08142 | 325 | 08310 | 8 | 08574 | 149 | 08749 | 593 | 08896 | 596 |
| 07602X5 | 155 | 07819 | 489 | 08016 | 125-287 | 08143 | 325 | 08311 | 8 | 08575 | 149 | 08750 | 593 | 08897 | 596 |
| 07603X10 | 321 | 07820 | 572 | 08019 | 527 | 08144 | 325 | 08312 | 8 | 08576 | 149 | 08751 | 593 | 08898 | 254-597 |
| 07604 | 233 | 07821 | 313 | 08020 | 527 | 08145 | 325 | 08314 | 278 | 08607/104 | 108 | 08752 | 593 | 08900 | 254-597 |
| 07607 | 462 | 07822 | 312 | 08021 | 527 | 08146 | 325 | 08315 | 278 | 08607/200 | 108 | 08753 | 592 | 08901 | 254-597 |
| 07608 | 275 | 07823 | 312 | 08023 | 2-243 | 08147 | 325 | 08319 | 278-558 | 08607/215 | 108 | 08754 | 592 | 08902 | 254-597 |
| 07609 | 275 | 07824 | 312 | 08024 | 581 | 08151 | 325 | 08321 | 172 | 08607/227 | 108 | 08755 | 593 | 08903 | 604 |
| 07610 | 275 | 07828 | 642 | 08025 | 581 | 08153 | 325 | 08322 | 172 | 08607/302 | 108 | 08756 | 594 | 08904 | 604 |
| 07615X6 | 160 | 07829 | 642 | 08026 | 72 | 08154 | 152 | 08323 | 172 | 08607/304 | 108 | 08758 | 593 | 08905 | 612 |
| 07616X6 | 160 | 07830 | 642 | 08031 | 626 | 08155 | 152-594 | 08325 | 172 | 08607/315 | 108 | 08759 | 592 | 08907 | 567 |
| 07617X4 | 160 | 07831 | 642 | 08032x8 | 580 | 08156 | 152 | 08326 | 172 | 08607/324 | 108 | 08761 | 339 | 08908 | 567 |
| 07622 | 276 | 07832 | 642 | 08033 | 100 | 08158 | 655 | 08327 | 172 | 08607/326 | 108 | 08765 | 172 | 08917 | 511 |
| 07627 | 275 | 07833 | 642 | 08034 | 685 | 08159 | 2-84 | 08328 | 172 | 08607/336 | 108 | 08769X10 | 623 | 08918 | 511 |
| 07631X6 | 160 | 07834 | 642 | 08035 | 685 | 08161 | 326 | 08329 | 172 | 08607/400 | 108 | 08770X10 | 623 | 08921 | 165-347 |
| 07632X4 | 160 | 07835 | 642 | 08036 | 685 | 08162 | 326 | 08330 | 172 | 08607/408 | 108 | 08771X10 | 623-660 | 08922 | 147 |
| 07633X6 | 160 | 07836 | 661 | 08037 | 685 | 08164 | 326 | 08332 | 172 | 08607/443 | 108 | 08772 | 623-660 | 08923 | 257 |
| 07634X3 | 160 | 07837 | 613 | 08039 | 685 | 08168 | 84-667 | 08333 | 172 | 08607/453 | 108 | 08773 | 659 | 08925 | 501 |
| 07635X4 | 160 | 07842 | 649 | 08040 | 685 | 08169 | 84-666 | 08336 | 172 | 08607/455 | 108 | 08774 | 659 | 08931 | 256 |
| 07636 | 30 | 07843 | 649 | 08041 | 684 | 08171 | 19 | 08337 | 172 | 08607/509 | 108 | 08775 | 659 | 08934 | 387 |
| 07637 | 30 | 07844 | 649 | 08042 | 684 | 08172 | 19 | 08353 | 341 | 08607/559 | 108 | 08776 | 659 | 08935 | 387 |
| 07644X10 | 320 | 07846 | 648 | 08043 | 684 | 08173 | 19 | 08354 | 520 | 08607/568 | 108 | 08777 | 2-243 | 08936 | 387 |
| 07645X10 | 320 | 07847 | 648 | 08044 | 684 | 08174 | 19 | 08355 | 522 | 08607/676 | 108 | 08778 | 6-243 | 08937 | 441 |
| 07651 | 439 | 07848 | 648 | 08045 | 514 | 08175 | 19 | 08357 | 36-678 | 08607/690 | 108 | 08780 | 191 | 08938 | 441 |
| 07652 | 172 | 07852 | 681 | 08051 | 21 | 08176 | 19 | 08358 | 36-678 | 08607/793 | 108 | 08781 | 191 | 08939 | 441 |
| 07653 | 172 | 07854 | 681 | 08052 | 177 | 08177 | 19 | 08359 | 561 | 08607/899 | 108 | 08782 | 191 | 08940 | 441 |
| 07654 | 526 | 07857 | 631 | 08053 | 179 | 08178 | 19 | 08360 | 561 | 08607/902 | 108 | 08783 | 191 | 08941 | 693 |
| 07657 | 526 | 07858 | 631 | 08054 | 179 | 08179 | 19 | 08361 | 561 | 08642 | 661 | 08784 | 173 | 08942</ | |

| | | | | | | | | | | | | | | | |
|----------|---------|----------|---------|----------|---------|---------|---------|---------|---------|-----------|---------|-------|--------|----------|---------|
| 08961X10 | 29 | 09219 | 33 | 09387/02 | 641 | 09545 | 132 | 09735 | 529 | 09914 | 440 | 10026 | 533 | 10157 | 546 |
| 08962X10 | 29 | 09222 | 635 | 09387/03 | 641 | 09547 | 132 | 09736 | 529 | 09915 | 625 | 10028 | 547 | 10161 | 595 |
| 08963X10 | 29 | 09223 | 635 | 09387/04 | 641 | 09549 | 624 | 09737 | 529 | 09916 | 221 | 10029 | 547 | 10162 | 539 |
| 08964X18 | 29 | 09223/53 | 635 | 09400 | 206 | 09550 | 662 | 09738 | 529 | 09924 | 628 | 10030 | 535 | 10163 | 539 |
| 08965X10 | 29 | 09224 | 635 | 09404 | 199 | 09551 | 662 | 09739 | 529 | 09926 | 628 | 10031 | 534 | 10164 | 539 |
| 08966X18 | 29 | 09224/53 | 635 | 09405 | 199 | 09553 | 662 | 09740 | 529 | 09927 | 677 | 10032 | 534 | 10165 | 539 |
| 08967X10 | 29 | 09225 | 635 | 09406 | 317 | 09555 | 643 | 09741 | 529 | 09928 | 493 | 10033 | 534 | 10166 | 541 |
| 08968 | 29 | 09225/53 | 635 | 09412 | 206 | 09556 | 643 | 09742 | 529 | 09930 | 677 | 10034 | 534 | 10167 | 541 |
| 08979x4 | 181 | 09226 | 613 | 09413 | 206 | 09557 | 644 | 09743 | 529 | 09931 | 574 | 10035 | 535 | 10168 | 542 |
| 08981 | 33 | 09240 | 588 | 09414 | 563 | 09559 | 644 | 09744 | 148 | 09932 | 574 | 10036 | 535 | 10169 | 542 |
| 08982 | 33 | 09241 | 577 | 09415 | 563 | 09560 | 643 | 09745 | 148 | 09933 | 574 | 10037 | 535 | 10170 | 542 |
| 08983 | 32 | 09242 | 577 | 09417 | 625 | 09566 | 624 | 09746 | 664 | 09934 | 574 | 10039 | 690 | 10171 | 542 |
| 08984 | 32 | 09243 | 577 | 09418 | 683 | 09568 | 624 | 09749 | 32 | 09935 | 574 | 10040 | 690 | 10172 | 544 |
| 08985 | 32 | 09244 | 577 | 09420 | 640-677 | 09571 | 257 | 09750 | 557 | 09936 | 574 | 10041 | 690 | 10173 | 536 |
| 08986 | 32 | 09246x4 | 579 | 09422 | 612 | 09572 | 452 | 09751 | 557 | 09937 | 574 | 10042 | 690 | 10175 | 544 |
| 08987 | 98 | 09247x4 | 579 | 09423 | 63 | 09573 | 624 | 09756 | 262 | 09938 | 574 | 10043 | 690 | 10176 | 544 |
| 08988 | 98 | 09248x4 | 579 | 09425 | 122 | 09576 | 477 | 09758 | 225-272 | 09939 | 349 | 10044 | 690 | 10177 | 535 |
| 08990 | 14 | 09250 | 592 | 09426 | 122 | 09579 | 576 | 09762 | 328 | 09940 | 677 | 10049 | 690 | 10179 | 535 |
| 08992/1 | 63 | 09251 | 592 | 09427 | 122 | 09583 | 109 | 09768 | 358 | 09943 | 648 | 1005 | 6 | 10181 | 546 |
| 08992/2 | 63 | 09252 | 592 | 09428 | 122 | 09584 | 109 | 09772 | 660 | 09944 | 651 | 10050 | 534 | 10182 | 546 |
| 08992/5 | 63 | 09253 | 316 | 09429 | 122 | 09585 | 109 | 09774 | 2 | 09945 | 651 | 10051 | 534 | 10183 | 546 |
| 08998/1 | 63 | 09257 | 509 | 09430 | 133 | 09587 | 110 | 09775 | 2 | 09946 | 651 | 10053 | 556 | 10184 | 546 |
| 08998/2 | 63 | 09258 | 509 | 09431 | 133 | 09588 | 110 | 09776 | 203 | 09951 | 78 | 10054 | 556 | 10185 | 546 |
| 09000 | 373 | 09261 | 662 | 09432 | 243 | 09589 | 113 | 09777 | 203 | 09952 | 78 | 10055 | 555 | 10186 | 546 |
| 09001 | 376 | 09263 | 624 | 09433 | 243 | 09591 | 104 | 09778 | 203 | 09953 | 78 | 10056 | 550 | 10187 | 559 |
| 09002 | 376 | 09265 | 510 | 09434 | 576 | 09592 | 104 | 09779 | 203 | 09954 | 78 | 10058 | 551 | 10188 | 559 |
| 09050 | 375 | 09266 | 510 | 09442 | 586 | 09593 | 104 | 09780 | 203 | 09955 | 78 | 10059 | 551 | 10189 | 536 |
| 09101 | 68 | 09268 | 692 | 09443 | 596 | 09595 | 653 | 09781 | 203 | 09956 | 78 | 10060 | 551 | 10193 | 683 |
| 09102 | 68 | 09269 | 692 | 09445 | 599 | 09597X4 | 471 | 09782 | 203 | 09957 | 440 | 10061 | 551 | 10194 | 683 |
| 09106X12 | 472 | 09270 | 692 | 09446 | 599 | 09598X4 | 471 | 09784 | 641 | 09958X6 | 139 | 10062 | 556 | 10195 | 549 |
| 09107X12 | 472 | 09271 | 89 | 09447 | 600 | 09599 | 471 | 09793 | 105 | 09960 | 38-304 | 10064 | 549 | 10196 | 549 |
| 09108X12 | 472 | 09272 | 89 | 09448 | 599 | 09600 | 694 | 09794 | 109 | 09962 | 660 | 10070 | 374 | 10199 | 555 |
| 09109X6 | 472 | 09273 | 89 | 09449 | 599 | 09601 | 694 | 09795 | 110 | 09963 | 548 | 10073 | 548 | 1020 | 2-243 |
| 09110X12 | 472 | 09274 | 89 | 09450 | 599 | 09602 | 694 | 09800 | 269 | 09968 | 621 | 10074 | 548 | 10200 | 359 |
| 09111X12 | 472 | 09275 | 89 | 09451 | 599 | 09603 | 694 | 09803 | 266 | 09969 | 547 | 10075 | 548 | 10201 | 594 |
| 09113X6 | 472 | 09276 | 89 | 09452 | 599 | 09604 | 680 | 09804 | 639 | 09970 | 381 | 10076 | 548 | 10203 | 621 |
| 09114 | 11 | 09277 | 89 | 09453 | 600 | 09606 | 694 | 09805 | 639 | 09972 | 374 | 10078 | 545 | 10204 | 533 |
| 09119 | 26 | 09279 | 89 | 09454 | 600 | 09607 | 694 | 09818 | 51 | 09974 | 591 | 10082 | 536 | 10209X24 | 145 |
| 09120 | 26 | 09280 | 89 | 09455 | 600 | 09616 | 576 | 09819 | 51 | 09975 | 591 | 10083 | 536 | 1021 | 2-243 |
| 09121 | 26 | 09281 | 692 | 09456 | 600 | 09617 | 516-686 | 09825 | 55 | 09976 | 591 | 10084 | 536 | 10215 | 683 |
| 09122 | 26 | 09283 | 692 | 09457 | 601 | 09620 | 516-686 | 09826 | 55 | 09977 | 662 | 10085 | 536 | 10217 | 360-583 |
| 09124/3 | 299 | 09284 | 258 | 09458 | 601 | 09621 | 577 | 09827 | 514 | 09978 | 662 | 10086 | 550 | 10218X48 | 160 |
| 09124/4 | 299 | 09285 | 257 | 09459 | 601 | 09622 | 577 | 09828 | 514 | 09979 | 662 | 10087 | 550 | 10219 | 439 |
| 09124/5 | 299 | 09286 | 510 | 09460 | 601 | 09623 | 576 | 09829 | 514 | 09980 | 550-661 | 10088 | 551 | 1022 | 6-243 |
| 09124/6 | 299 | 09287 | 510 | 09461 | 601 | 09624 | 516-686 | 09831 | 515 | 09982 | 661-662 | 10089 | 551 | 10220 | 498 |
| 09132X4 | 299 | 09288 | 510 | 09462 | 604 | 09625 | 516-686 | 09832 | 255-514 | 09983 | 661-662 | 10090 | 551 | 10221 | 498 |
| 09133 | 298 | 09289 | 510 | 09464 | 604 | 09626 | 516-686 | 09833 | 514 | 09984 | 374 | 10091 | 551 | 10222 | 459 |
| 09134 | 298 | 09290 | 692 | 09465 | 606 | 09627 | 652 | 09834 | 515 | 09985x5 | 149 | 10092 | 551 | 10225 | 552-663 |
| 09136 | 298 | 09291 | 692 | 09466 | 606 | 09629 | 649 | 09835 | 515 | 09986 | 374 | 10093 | 551 | 10226 | 552-663 |
| 09142 | 284 | 09292 | 511 | 09467 | 606 | 09640 | 382 | 09839 | 228 | 09987 | 645 | 10094 | 594 | 10227 | 552-663 |
| 09144 | 2-243 | 09299 | 26 | 09468 | 606 | 09641 | 382 | 09840 | 641 | 09988 | 645 | 10095 | 533 | 10228 | 552-663 |
| 09145 | 638 | 09318 | 490 | 09469 | 606 | 09642 | 382 | 09841 | 513 | 09990 | 546 | 10096 | 539 | 10229 | 552-663 |
| 09146 | 638 | 09319 | 490 | 09470 | 606 | 09643 | 382 | 09842 | 513 | 09991 | 375 | 10097 | 537 | 1023 | 6-243 |
| 09147 | 453 | 09320 | 491 | 09471 | 606 | 09644 | 382 | 09843 | 513 | 09992 | 374 | 10098 | 537 | 10231 | 551 |
| 09148 | 292 | 09321 | 491 | 09472 | 606 | 09646 | 382 | 09844 | 513 | 09996 | 375 | 10099 | 548 | 10232 | 563 |
| 09149 | 631 | 09322 | 490 | 09473 | 605 | 09647 | 382 | 09845 | 513 | 09997 | 375 | 1010 | 6 | 10233 | 563 |
| 09150 | 298 | 09328 | 491 | 09474 | 605 | 09648 | 382 | 09846 | 664 | 09998 | 375 | 10100 | 537 | 10234 | 594 |
| 09151 | 298 | 09329 | 284 | 09475 | 605 | 09649 | 382 | 09847 | 632 | 09999 | 375 | 10101 | 538 | 10235 | 626 |
| 09152 | 298 | 09330 | 284 | 09477 | 605 | 09653 | 510 | 09848 | 632 | 1/20 | 310 | 10102 | 538 | 10236 | 626 |
| 09153 | 153 | 09331 | 284 | 09478 | 605 | 09654 | 145 | 09849 | 632 | 1/250 | 308 | 10103 | 538 | 10237 | 626 |
| 09154 | 153 | 09332 | 284 | 09479 | 608 | 09656 | 145 | 09850 | 632 | 1/251/10 | 308 | 10104 | 538 | 10239 | 65 |
| 09158 | 582 | 09343X10 | 528 | 09480 | 605 | 09657 | 145 | 09851 | 632 | 1/251/14 | 308 | 10105 | 538 | 1024 | 2-243 |
| 09159 | 582-700 | 09344X10 | 528 | 09481 | 608 | 09659 | 145 | 09852 | 632 | 1/251/2.5 | 308 | 10106 | 538 | 10240 | 275-476 |
| 09160 | 582 | 09345X10 | 528 | 09482X3 | 605 | 09663 | 145 | 09853 | 631 | 1/251/20 | 308 | 10107 | 538 | 10241 | 65 |
| 09161 | 582 | 09346X10 | 528 | 09483 | 609 | 09664 | 145 | 09856 | 157 | 1/251/3.5 | 308 | 10108 | 538 | 10242 | 65 |
| 09164 | 582 | 09347 | 683 | 09484 | 609 | 09665 | 145 | 09857 | 157 | 1/251/5 | 308 | 10109 | 537 | 10243 | 65 |
| 09165 | 73 | 09348 | 683 | 09485 | 609 | 09666 | 145 | 09859 | 6 | 1/251/7 | 308 | 10110 | 559 | 10244 | 65 |
| 09166 | 250 | 09350X10 | 528 | 09486 | 609 | 09667 | 145 | 09861 | 109 | 1/252 | 308 | 10111 | 559 | 10245 | 65 |
| 09167 | 193 | 09351 | 528 | 09488 | 609 | 09668 | 145 | 09862 | 105 | 1/253 | 308 | 10112 | 559 | 10246 | 65 |
| 09169 | 157 | 09352 | 528 | 09489 | 609 | 09669 | 145 | 09865 | 108 | 1/254 | 308 | 10113 | 559 | 10247 | 65 |
| 09171 | 607 | 09353 | 270 | 09490 | 609 | 09670 | 145 | 09868 | 502 | 1/255 | 308 | 10114 | 559 | 1025 | 6 |
| 09172 | 608 | 09354 | 425 | 09499 | 650 | 09671 | 145 | 09869 | 213 | 1000 | 6 | 10115 | 559 | 10250 | 510 |
| 09173 | 608 | 09356 | 425 | 09500 | 650 | 09672 | 145 | 09876 | 688 | 10002 | 239 | 10116 | 376 | 10251 | 556 |
| 09174 | 608 | 09357 | 425-597 | 09501 | 650 | 09673 | 145 | 09877 | 688 | 10003 | 533 | 10117 | 376 | 10252 | 556 |
| 09175 | 607 | 09358 | 425 | 09505 | 650 | 09674 | 214 | 09878 | 688 | 10004 | 533 | 10118 | 85-671 | 10253 | 554 |
| 09176 | 607 | 09359 | 425 | 09507 | 651 | 09675 | 214 | 09879 | 688 | 10005 | 533 | 10119 | 85-671 | 10254 | 549 |
| 09177 | 607 | 09362 | 596 | 09508 | 651 | 09676 | 201 | 09880 | 688 | 10006 | 533 | 10120 | 535 | 10255 | 640 |
| 09178 | 607 | 09368 | 680 | 09510 | 651 | 09681 | 262 | 09881X6 | 688 | 10007 | 533 | 10121 | 534 | 10256 | 577 |
| 09179 | 604 | 09369 | 669 | 09511 | 651 | 09682 | 51 | 09882 | 105 | 10008 | 533 | 10122 | 545 | 10258 | 572 |
| 09181 | 582 | 09370 | 453 | 09513 | 651 | 09683 | 51 | 09883 | 102 | 10009 | 533 | 10130 | 594 | 10259 | 572 |
| 09182 | 472 | 09371 | 452 | 09514 | 651 | 09685 | 511 | 09884 | 102 | 10010 | 533 | 10134 | 174 | 10260 | 554 |
| 09183 | 114 | 09372 | 693 | 09516 | 651 | 09686 | 289 | 09885 | 280 | 10011 | 611 | 10135 | 550</ | | |

| | | | | | | | | | | | | | | | |
|------------|---------|----------|---------|----------|-----|-----------|-----|----------|---------|----------|---------|----------|---------|------------|-----|
| 10275 | 506 | 1039 | 210-319 | 10582 | 119 | 10762X13 | 143 | 10969 | 27 | 11200 | 570 | 11384 | 558 | 11524/3 | 221 |
| 10276 | 506 | 10390 | 572 | 10583X6 | 119 | 10763X22 | 143 | 10974 | 40 | 11201 | 570 | 11385 | 562 | 11524/4 | 221 |
| 10282 | 506 | 10391 | 572 | 1060/10 | 301 | 10764X7 | 143 | 10975 | 40 | 11202 | 570 | 11386 | 562 | 11524/5 | 221 |
| 10283 | 507 | 10392 | 646 | 1060/200 | 301 | 10765X19 | 144 | 10976 | 40 | 11205 | 455 | 11387 | 320 | 11524/6 | 221 |
| 10284 | 507 | 10393 | 674 | 1060/50 | 301 | 10766X14 | 144 | 10977 | 40 | 1122 | 457 | 11388 | 562 | 11530 | 668 |
| 10285 | 507 | 10394 | 435 | 10606 | 134 | 10767X16 | 143 | 10978 | 40 | 11225 | 113 | 11393X10 | 320 | 11532 | 276 |
| 10286 | 507 | 10395 | 435 | 10607 | 134 | 10768X30 | 142 | 10979 | 40 | 11226 | 28 | 11394 | 340 | 11533 | 456 |
| 10287 | 507 | 10396 | 429 | 10608 | 134 | 10769 | 142 | 10980/1 | 40 | 11227 | 28 | 11395 | 340 | 11535/103 | 107 |
| 10288 | 507 | 10397 | 429 | 10609 | 134 | 10770X3 | 143 | 10980/10 | 40 | 11228 | 28 | 11396 | 193 | 11535/104 | 107 |
| 1029 | 323 | 10398 | 429 | 10610 | 134 | 10771X16 | 142 | 10980/11 | 40 | 11229 | 200 | 11397 | 210 | 11535/151 | 107 |
| 10291 | 652 | 10399 | 671 | 10611 | 134 | 10772X25 | 142 | 10980/12 | 40 | 11230X10 | 28 | 11398 | 461 | 11535/152 | 107 |
| 10292 | 652 | 1040 | 301 | 10612 | 134 | 10773X10 | 142 | 10980/13 | 40 | 11231 | 547-612 | 11399 | 461 | 11535/157 | 107 |
| 10293 | 652 | 10400 | 518 | 10613 | 134 | 10774 | 504 | 10980/2 | 40 | 11232 | 547-612 | 114 | 214 | 11535/161 | 107 |
| 10298 | 573 | 10401 | 167 | 10614 | 134 | 10821 | 125 | 10980/3 | 40 | 11233 | 294 | 11400 | 461 | 11535/201 | 107 |
| 10299 | 573 | 10402 | 500-518 | 10615 | 134 | 10823 | 125 | 10980/4 | 40 | 11234 | 575 | 11401 | 464 | 11535/210 | 107 |
| 10300 | 573 | 10403X10 | 21 | 10616 | 134 | 10824 | 151 | 10980/5 | 40 | 11238 | 135 | 11402 | 456 | 11535/213 | 107 |
| 10301 | 573 | 10404X10 | 21 | 10617 | 134 | 10825 | 219 | 10980/6 | 40 | 11239 | 135 | 11403 | 463 | 11535/215 | 107 |
| 10302 | 573 | 10405X10 | 21 | 10618 | 134 | 10826 | 219 | 10980/7 | 40 | 11244 | 519 | 11404 | 463 | 11535/227 | 107 |
| 10303 | 285 | 10406X10 | 21 | 10619 | 134 | 10827 | 248 | 10980/8 | 40 | 1125 | 456 | 11405 | 461 | 11535/301 | 107 |
| 10304 | 435 | 10407X10 | 21 | 1062/10 | 301 | 10828 | 248 | 10980/9 | 40 | 11254 | 116 | 11406 | 461 | 11535/302 | 107 |
| 1031 | 243-319 | 10408X10 | 21 | 1062/50 | 301 | 10829 | 248 | 10995/1 | 41 | 11258 | 317 | 11407 | 121 | 11535/304 | 107 |
| 10310 | 434 | 10409X10 | 21 | 10620 | 134 | 10830 | 248 | 10995/2 | 41 | 11259/1 | 315 | 11408 | 121 | 11535/315 | 107 |
| 10311 | 435 | 1041 | 301 | 10621 | 134 | 10831 | 248 | 10995/3 | 41 | 11259/2 | 315 | 11409 | 612 | 11535/324 | 107 |
| 10312 | 662 | 10410X10 | 21 | 10622 | 134 | 10832 | 160 | 10995/4 | 41 | 11259/3 | 315 | 11410 | 462 | 11535/326 | 107 |
| 10314 | 636 | 10411X10 | 21 | 10623 | 134 | 10833 | 160 | 10995/5 | 41 | 11265/1 | 311 | 11411 | 462 | 11535/336 | 107 |
| 10316 | 434 | 10412X10 | 21 | 10624 | 134 | 10834 | 173 | 1100 | 468 | 11265/2 | 311 | 11412X5 | 166 | 11535/400 | 107 |
| 10317 | 434 | 10413 | 21 | 10625 | 134 | 10835 | 173 | 11000/0 | 116 | 11273/3 | 315 | 11414 | 166 | 11535/408 | 107 |
| 10318 | 434 | 10414 | 21 | 10626 | 134 | 10836 | 173 | 11000/10 | 116 | 11276/2 | 315 | 11415X5 | 166 | 11535/443 | 107 |
| 1032/1 | 210-319 | 10421 | 40 | 10627 | 134 | 10837 | 174 | 11000/12 | 116 | 11277/1 | 312 | 11416X5 | 166 | 11535/445 | 107 |
| 1032/1/500 | 210-319 | 10422 | 40 | 1063/10 | 301 | 10839 | 156 | 11000/14 | 116 | 11277/2 | 312 | 11417X5 | 166 | 11535/450 | 107 |
| 1032/2 | 210-319 | 10423 | 40 | 1063/200 | 301 | 10841X12 | 145 | 11000/16 | 116 | 11279/1 | 311 | 11418X10 | 166 | 11535/453 | 107 |
| 1032/2/500 | 210-319 | 10424 | 40 | 10634 | 213 | 10845X12 | 145 | 11000/2 | 116 | 11279/2 | 311 | 11419 | 670 | 11535/455 | 107 |
| 1032/24 | 210-319 | 10425 | 40 | 10635 | 213 | 10847X12 | 145 | 11000/20 | 116 | 11281/1 | 312 | 11421 | 569 | 11535/509 | 107 |
| 1032/3 | 210-319 | 10426 | 40 | 10639 | 214 | 10849 | 121 | 11000/4 | 116 | 11281/2 | 312 | 11425X12 | 476 | 11535/538 | 107 |
| 1032/3/500 | 210-319 | 10427 | 40 | 1064/10 | 301 | 10850 | 553 | 11000/6 | 116 | 11281/3 | 312 | 11426 | 210 | 11535/559 | 107 |
| 10320 | 374 | 10429 | 201 | 1064/50 | 301 | 10851 | 553 | 11000/8 | 116 | 11284 | 246-318 | 11427 | 210 | 11535/568 | 107 |
| 10328x6 | 149 | 10430 | 201 | 10640 | 77 | 10852 | 341 | 1102 | 468 | 11285 | 246-318 | 11428 | 210 | 11535/601 | 107 |
| 10329x6 | 149 | 10431 | 201 | 10642 | 40 | 10853 | 341 | 11020/10 | 116 | 11286 | 246-318 | 11429 | 210 | 11535/676 | 107 |
| 1033 | 6 | 10432 | 201 | 1065/10 | 301 | 10854 | 639 | 11020/12 | 116 | 11287 | 246-318 | 11430 | 54-267 | 11535/684 | 107 |
| 10330 | 149 | 10433 | 201 | 1065/50 | 301 | 10855 | 639 | 11020/14 | 116 | 11288 | 246-318 | 11432 | 427 | 11535/687 | 107 |
| 10331 | 149 | 10434 | 201 | 10655 | 217 | 10856 | 543 | 11020/16 | 116 | 11289 | 246-318 | 11433 | 426 | 11535/688 | 107 |
| 10332 | 149 | 10443 | 209 | 10678 | 217 | 10857 | 543 | 11020/2 | 116 | 11290 | 246-318 | 11434 | 426 | 11535/690 | 107 |
| 10333 | 453 | 10444 | 254-597 | 10679 | 216 | 10858 | 543 | 11020/20 | 116 | 11291 | 246-318 | 11436 | 421 | 11535/791 | 107 |
| 10334 | 424 | 10445 | 254-597 | 10696 | 301 | 10859 | 543 | 11020/4 | 116 | 11298 | 246-318 | 11437 | 421 | 11535/793 | 107 |
| 10335x5 | 257 | 10446 | 254-597 | 10697 | 301 | 1086 | 289 | 11020/6 | 116 | 11299 | 246-318 | 11439 | 420 | 11535/797 | 107 |
| 10336 | 258 | 10447 | 254-597 | 1070/10 | 301 | 10860 | 35 | 11020/8 | 116 | 113/1 | 212 | 1144 | 451 | 11535/901 | 107 |
| 10337 | 258 | 10448 | 254-597 | 1070/50 | 301 | 10861 | 35 | 1104 | 468 | 113/2 | 212 | 11441 | 335 | 11535/902 | 107 |
| 10338 | 258 | 10449 | 254-597 | 10700 | 217 | 10862 | 35 | 1105 | 468 | 113/3 | 212 | 11442 | 525 | 11535/975 | 107 |
| 10339 | 258 | 1045 | 301 | 10701 | 217 | 10863 | 35 | 1108 | 468 | 113/4 | 212 | 11444 | 525 | 11535/A5 | 107 |
| 1034 | 6 | 10450 | 77 | 10702 | 217 | 10864 | 35 | 111/01 | 213 | 113/5 | 212 | 11445 | 525 | 1153x10 | 180 |
| 10340 | 248 | 10451 | 77 | 10703 | 217 | 10865 | 35 | 111/02 | 213 | 113/7 | 212 | 11446 | 525 | 1154x12 | 179 |
| 10342 | 651 | 10452 | 274 | 10704 | 217 | 10866 | 642 | 111/03 | 213 | 11300 | 246-318 | 11448 | 54 | 1155x5 | 179 |
| 10345 | 690 | 10453 | 553 | 10705 | 217 | 10867 | 642 | 111/04 | 213 | 11302 | 318 | 11449 | 594 | 11577 | 110 |
| 10346 | 689 | 10454 | 553 | 10706 | 217 | 10868 | 642 | 111/05 | 213 | 11305 | 246 | 1145 | 467 | 11578 | 110 |
| 10348 | 339 | 1046 | 301 | 10707 | 217 | 10869 | 642 | 111/06 | 213 | 11306 | 246 | 1145/96 | 452 | 11580 | 208 |
| 10349 | 650-667 | 10463X6 | 143 | 10710 | 112 | 10870 | 635 | 111/07 | 213 | 11307 | 246 | 11450X6 | 125 | 11581 | 208 |
| 1035 | 6 | 10460 | 301 | 10711 | 18 | 10871 | 635 | 111/08 | 213 | 11308 | 246 | 11451 | 202 | 11582 | 431 |
| 10350 | 650-669 | 1050/10 | 301 | 10712 | 18 | 10872 | 635 | 111/09 | 213 | 1131 | 459 | 11452 | 201 | 11586 | 292 |
| 10351 | 661 | 10506 | 112 | 10713/01 | 18 | 10873 | 635 | 111/1 | 213 | 11312 | 160 | 11453 | 112-476 | 1159 | 180 |
| 10353 | 661 | 10507 | 112 | 10713/02 | 18 | 10874 | 641 | 111/10 | 213 | 11313 | 160 | 11454 | 57 | 11591 | 202 |
| 10354 | 663 | 10508 | 112 | 10713/03 | 18 | 10876 | 11 | 111/11 | 213 | 11316 | 188 | 11455 | 57 | 11592 | 202 |
| 10355X5 | 140 | 10509 | 112 | 10713/04 | 18 | 10880 | 69 | 111/12 | 213 | 11319 | 254-597 | 11456 | 123 | 11593 | 202 |
| 10356 | 650 | 10511 | 632 | 10713/05 | 18 | 10885 | 151 | 1115/16 | 440 | 11326 | 167 | 11458 | 168 | 11595 | 580 |
| 10357 | 640-677 | 10531 | 16 | 10713/06 | 18 | 10886 | 151 | 1115/96 | 440 | 11327 | 552-624 | 11459 | 170 | 11596 | 580 |
| 10358 | 628 | 10532 | 16 | 10713/07 | 18 | 10887 | 200 | 1115/V | 440 | 11328 | 668 | 11460 | 170 | 11597 | 637 |
| 1036/2 | 319 | 10534 | 113 | 10713/08 | 18 | 10888 | 200 | 1116 | 455 | 11329 | 98 | 11462 | 432 | 11598 | 580 |
| 10360 | 644 | 10536 | 113 | 10713/10 | 18 | 10889 | 200 | 11162/1 | 40 | 11330 | 102 | 11471 | 298 | 11599 | 431 |
| 10361 | 636 | 10546 | 114 | 10713/11 | 18 | 10890 | 200 | 11162/2 | 40 | 11331 | 206 | 11472 | 298 | 1160/12 | 260 |
| 10362 | 636 | 10547 | 114 | 10713/12 | 18 | 10891 | 200 | 11162/3 | 40 | 11332 | 206 | 11473 | 81-98 | 11600 | 431 |
| 10363 | 636 | 10548 | 114 | 10713/13 | 18 | 10892 | 216 | 11162/4 | 40 | 11333 | 206 | 11475 | 110 | 11601/01 | 193 |
| 10364 | 636 | 10549 | 114 | 10713/14 | 18 | 10920/100 | 72 | 11162/5 | 40 | 11334 | 206 | 11479 | 141 | 11602 | 677 |
| 10365 | 36 | 10550 | 114 | 10713/15 | 18 | 10920/15 | 72 | 11162/6 | 40 | 11335 | 206 | 1148 | 267-474 | 11605 | 172 |
| 10366 | 36 | 10551 | 75 | 10713/16 | 18 | 10920/20 | 72 | 11162/7 | 40 | 11336 | 174 | 11480 | 40 | 11606 | 172 |
| 10367 | 692 | 10552 | 75 | 10713/17 | 18 | 10920/25 | 72 | 11168/1 | 41 | 11337 | 174 | 11481 | 40 | 11607 | 471 |
| 10369 | 18 | 10553 | 75 | 10713/18 | 18 | 10920/30 | 72 | 11168/2 | 41 | 11338 | 174 | 11482 | 40 | 1161/6 | 260 |
| 1037 | 319 | 10554 | 74 | 10713/19 | 18 | 10920/40 | 72 | 1117 | 436-456 | 11339 | 174 | 11483 | 40 | 11610/1318 | 162 |
| 10370 | 611 | 10555 | 75 | 10713/20 | 18 | 10920/50 | 72 | 1117/V | 436 | 11340 | 174 | 11484 | 40 | 11610/1824 | 162 |
| 10371 | 429 | 10557 | 111 | 10713/21 | 18 | 10920/70 | 72 | 11170/1 | 41 | 11341 | 87 | 11490 | 187 | 11610/2030 | 162 |
| 10372 | 429 | 10558 | 268 | 10732 | 11 | 10935/15 | 72 | 11170/2 | 41 | 11342 | 87 | 11491 | 187 | | |

| | | | | | | | | | | | | | | | |
|------------|--------|------------|---------|-----------|---------|------------|-----|----------|---------|-----------|--------|------------|---------|---------|---------|
| 11635 | 313 | 11751/07 | 196 | 11857/14 | 240 | 1202 | 294 | 12128/07 | 43 | 12299/104 | 4 | 12434/052 | 564 | 12571 | 322 |
| 11636 | 315 | 11751/10 | 197 | 11857/15 | 240 | 12020 | 347 | 12128/08 | 43 | 12299/105 | 4 | 12434/053 | 564 | 12573 | 68 |
| 11637 | 312 | 11751/11 | 197 | 11857/16 | 240 | 12022 | 106 | 12128/09 | 43 | 12299/121 | 4-27 | 12434/054 | 564 | 12574 | 68 |
| 11649 | 72 | 11751/12 | 197 | 11857/17 | 240 | 12023 | 186 | 12128/10 | 43 | 12299/250 | 5 | 12434/101 | 564 | 12575x4 | 68 |
| 11650 | 72 | 11751/13 | 197 | 11857/18 | 240 | 12024 | 186 | 12128/11 | 43 | 123/100 | 275 | 12434/102 | 564 | 12576x4 | 68 |
| 11651 | 72 | 11751/14 | 197 | 11857/19 | 240 | 12025 | 186 | 12128/12 | 43 | 123/1000 | 275 | 12434/103 | 564 | 12577x4 | 68 |
| 11657 | 137 | 11751/15 | 197 | 11857/20 | 240 | 12026 | 186 | 12128/13 | 43 | 123/250 | 275 | 12434/104 | 564 | 12578x4 | 68 |
| 11658 | 137 | 11751/16 | 197 | 1187/100 | 298 | 12027 | 186 | 12128/14 | 43 | 123/500 | 275 | 12442/051 | 564 | 12579x4 | 68 |
| 11659 | 137 | 11751/17 | 197 | 11877 | 274 | 12028 | 186 | 12128/15 | 43 | 1230 | 295 | 12442/052 | 564 | 12580x4 | 68 |
| 11660 | 137 | 11751/18 | 197 | 11878 | 463 | 12029 | 186 | 12128/16 | 43 | 12301/250 | 5 | 12442/053 | 564 | 12581x4 | 68 |
| 11661 | 137 | 11751/19 | 197 | 11879 | 555 | 12030 | 274 | 12128/17 | 43 | 12302/50 | 5 | 12442/054 | 564 | 12582x4 | 68 |
| 11662 | 137 | 11751/20 | 197 | 11880 | 555 | 12031 | 274 | 12128/18 | 43 | 12303/50 | 5 | 12442/101 | 564 | 12583 | 146 |
| 11665 | 457 | 11751/21 | 197 | 11882 | 523 | 12033 | 274 | 12128/19 | 43 | 12304/100 | 5-26 | 12442/102 | 564 | 12584 | 77 |
| 11666 | 457 | 11751/22 | 197 | 11883 | 523 | 12035 | 509 | 12128/20 | 43 | 12304/101 | 4 | 12442/103 | 564 | 12585x4 | 314 |
| 11668 | 266 | 11751/23 | 197 | 11884 | 294 | 12037/1 | 265 | 12128/21 | 43 | 12305/100 | 5 | 12442/104 | 564 | 12586 | 314 |
| 11669/1 | 266 | 11751/24 | 197 | 11885 | 521 | 12037/2 | 265 | 12128/22 | 43 | 12306/100 | 5-26 | 12442/4 | 565 | 12588 | 136 |
| 11669/2 | 266 | 11751/25 | 197 | 11888 | 521 | 12040/1 | 265 | 12128/23 | 43 | 12306/101 | 4 | 12450/051 | 564 | 12591 | 22 |
| 11672/1 | 266 | 11774 | 458 | 11890 | 521 | 12040/1x10 | 50 | 12151/1 | 35 | 12306/102 | 4 | 12450/052 | 564 | 12592 | 22 |
| 11674 | 266 | 11775/01 | 196 | 11891 | 520 | 12040/2 | 265 | 12151/2 | 35 | 12306/103 | 4 | 12450/101 | 564 | 12593 | 22 |
| 11675/1x10 | 266 | 11775/02 | 196 | 11892 | 520 | 12040/2x10 | 50 | 12153 | 296 | 12306/104 | 4 | 12450/102 | 564 | 12594 | 22 |
| 11675/2x10 | 266 | 11775/03 | 196 | 11893 | 522 | 12040/3 | 265 | 12154 | 296 | 12306/105 | 4 | 12455/1 | 10 | 12595 | 249 |
| 11675/3x10 | 266 | 11775/04 | 196 | 11894 | 123 | 12040/3x10 | 50 | 12155 | 296 | 12306/120 | 4 | 12455/2 | 10 | 12596 | 249 |
| 11675/4x10 | 266 | 11775/05 | 196 | 11895 | 292 | 12040/4 | 265 | 12156 | 296 | 12306/121 | 4-27 | 12457/1 | 214 | 12597 | 249 |
| 11675/5x10 | 266 | 11775/06 | 196 | 11896 | 292 | 12040/4x10 | 50 | 12157 | 296 | 12307/100 | 5 | 12457/2 | 214 | 12598 | 249 |
| 11679/1 | 265 | 11775/07 | 196 | 11897 | 296 | 12045 | 152 | 12158 | 296 | 12308/100 | 5-26 | 12457/3 | 214 | 12599/1 | 250 |
| 11679/1x12 | 50 | 11775/10 | 197 | 11898 | 296 | 12047 | 195 | 12159 | 296 | 12308/101 | 4 | 12457/4 | 214 | 12599/2 | 250 |
| 11679/2 | 265 | 11775/11 | 197 | 11899 | 296 | 12048 | 96 | 12160 | 296 | 12309/100 | 5 | 12457/5 | 214 | 12601/1 | 250 |
| 11679/2x12 | 50 | 11775/12 | 197 | 11900 | 295 | 12049 | 96 | 121x6 | 214 | 12310/100 | 5-26 | 12457/6 | 214 | 12601/2 | 250 |
| 1168/12 | 260 | 11775/13 | 197 | 11901 | 295 | 12052 | 511 | 122 | 214 | 12310/101 | 4 | 12472 | 167 | 12603/1 | 249 |
| 11682/1 | 265 | 11775/14 | 197 | 11902 | 295 | 12053 | 560 | 1220 | 294 | 12310/102 | 4 | 12473 | 167 | 12603/2 | 249 |
| 11682/1x10 | 50 | 11775/15 | 197 | 11903 | 295 | 12054 | 560 | 12224 | 493 | 12310/103 | 4 | 12474 | 167 | 12603/3 | 249 |
| 11682/2 | 265 | 11775/16 | 197 | 11905 | 296 | 12055 | 560 | 12225 | 493 | 12310/104 | 4 | 12476x24 | 77 | 12603/4 | 249 |
| 11682/2x10 | 50 | 11775/17 | 197 | 11906 | 296 | 12056 | 643 | 12226 | 493 | 12310/105 | 4 | 12477x12 | 77 | 12607 | 170 |
| 11682/3 | 265 | 11775/18 | 197 | 11908 | 137 | 12057 | 643 | 12227 | 493 | 12310/120 | 4 | 12478 | 77 | 12608 | 187 |
| 11682/3x10 | 50 | 11775/19 | 197 | 11909 | 86 | 12058 | 643 | 12228 | 493 | 12310/121 | 4-27 | 1248/00x12 | 71 | 12609 | 190 |
| 11682/4 | 265 | 11775/20 | 197 | 11910 | 86 | 12059 | 59 | 12229x10 | 321 | 12311/100 | 5 | 1248/01x12 | 71 | 12610 | 187 |
| 11682/4x10 | 50 | 11775/21 | 197 | 11915 | 326 | 12060 | 111 | 12231x16 | 139 | 12314 | 548 | 1248/02x12 | 71 | 12611 | 187 |
| 11687 | 186 | 11775/22 | 197 | 11917 | 326 | 12060/1 | 111 | 12233 | 161 | 12317 | 65-275 | 1248/03x12 | 71 | 12612 | 188 |
| 11688 | 186 | 11775/23 | 197 | 11918 | 326 | 12060/2 | 111 | 12234 | 161-480 | 12318 | 693 | 1248/04x12 | 71 | 12613 | 188 |
| 11689 | 186 | 11775/24 | 197 | 11919 | 326 | 12060/3 | 111 | 12235 | 161 | 12319 | 540 | 1248/05x12 | 71 | 12614 | 191 |
| 11690 | 185 | 11775/25 | 197 | 11920 | 326 | 12061 | 275 | 12239 | 550 | 12320 | 540 | 1248/06x12 | 71 | 12615 | 170-191 |
| 11691/01 | 63 | 11797 | 196 | 11921 | 326 | 12062 | 42 | 12240 | 322 | 12321 | 540 | 1248/07x12 | 71 | 12616 | 190 |
| 11691/02 | 63 | 11798 | 196 | 11922 | 326 | 12063/1 | 42 | 12241 | 322 | 12322 | 540 | 1248/08x12 | 71 | 12617 | 190 |
| 11691/08 | 63 | 1175P/7 | 76 | 11924 | 326 | 12063/2 | 42 | 12242 | 322 | 12326 | 350 | 1248/09x12 | 71 | 12618 | 190 |
| 11691/14 | 63 | 1180/100 | 298 | 11927 | 326 | 12063/3 | 42 | 12243 | 322 | 12327 | 351 | 1248/10x12 | 71 | 12619 | 187 |
| 11691/21 | 63 | 11800 | 82 | 11931/2 | 297-326 | 12066 | 42 | 12244 | 322 | 12328/1 | 351 | 1248/11x12 | 71 | 12620 | 187 |
| 11691/26 | 63 | 11801 | 82 | 11931/3 | 297-326 | 12068 | 87 | 12245 | 322 | 12328/2 | 351 | 1248/12x12 | 71 | 12621 | 187 |
| 11691/A | 63 | 11802 | 82 | 11931/4 | 297-326 | 12069 | 123 | 12246 | 161 | 12330/1 | 352 | 12480 | 84-346 | 12622/1 | 193 |
| 117/10 | 76-214 | 11803 | 82 | 11940 | 6-243 | 12070 | 273 | 12247 | 175 | 12330/2 | 352 | 12481 | 101 | 12622/2 | 193 |
| 117/6 | 76-214 | 11804 | 82 | 11941 | 6-243 | 12071 | 273 | 12251 | 571 | 12332 | 349 | 125 | 215-229 | 12622/3 | 193 |
| 11700/01 | 64 | 11805 | 82 | 11942 | 240 | 12075 | 385 | 12253 | 122 | 12333 | 350 | 12506 | 4 | 12622/4 | 193 |
| 11700/02 | 64 | 11807 | 658 | 11943 | 644 | 12076 | 385 | 12254 | 122 | 12334/1 | 356 | 12507 | 4 | 12626 | 193 |
| 11700/06 | 64 | 11811 | 653 | 11944 | 106 | 12077 | 385 | 12255 | 133 | 12334/2 | 356 | 12508 | 60 | 12627 | 193 |
| 11700/07 | 64 | 11812 | 453-653 | 11945 | 107 | 12078 | 385 | 12256 | 133 | 12334/3 | 356 | 12509 | 60 | 12628 | 193 |
| 11700/08 | 64 | 11813 | 653 | 11946 | 107 | 12079 | 385 | 12257 | 440 | 12337 | 356 | 12510 | 298 | 12629 | 192 |
| 11700/10 | 64 | 11814 | 653 | 11947/104 | 106 | 12087 | 10 | 12259 | 92 | 12338 | 354 | 12511 | 155 | 12630 | 193 |
| 11700/11 | 64 | 11815 | 476 | 11947/201 | 106 | 12088 | 10 | 12260 | 92 | 12339 | 436 | 12512x4 | 102 | 12631 | 184 |
| 11700/12 | 64 | 11816 | 476 | 11947/210 | 106 | 12089 | 10 | 12261 | 92 | 12340 | 436 | 12513 | 102 | 12632 | 184 |
| 11700/14 | 64 | 11823 | 653 | 11947/215 | 106 | 12090 | 10 | 12262 | 92 | 12341 | 354 | 12518 | 347 | 12633 | 184 |
| 11700/17 | 64 | 11834 | 196 | 11947/227 | 106 | 12091 | 10 | 12263 | 92 | 12342 | 352 | 12520 | 696 | 12634 | 184 |
| 11700/21 | 64 | 11835 | 196 | 11947/302 | 106 | 12092 | 10 | 12264 | 92 | 12343 | 349 | 12521/1000 | 696 | 12635 | 184 |
| 11700/25 | 64 | 11836 | 197 | 11947/304 | 106 | 12093 | 432 | 12265 | 617 | 12344 | 351 | 12524 | 699 | 12636 | 184 |
| 11700/26 | 64 | 11837 | 197 | 11947/315 | 106 | 12094 | 432 | 12266 | 617 | 12345 | 351 | 12534 | 696 | 12637 | 184 |
| 11700/28 | 64 | 11838 | 197 | 11947/324 | 106 | 12095 | 432 | 12267 | 617 | 12346 | 350 | 12536 | 59 | 12638 | 183 |
| 11700/40 | 64 | 11839 | 197 | 11947/326 | 106 | 12096 | 432 | 12268 | 617 | 12347 | 353 | 1254/4B | 261 | 12639 | 183 |
| 11700/41 | 64 | 11840 | 196 | 11947/336 | 106 | 12097 | 432 | 12269 | 617 | 12348/1 | 442 | 1254/4G | 261 | 12640 | 183 |
| 11700/42 | 64 | 11841 | 196 | 11947/400 | 106 | 12098 | 432 | 12270 | 616 | 12348/2 | 442 | 12541 | 697 | 12641 | 183 |
| 11700/43 | 64 | 11842 | 196 | 11947/408 | 106 | 12099 | 38 | 12271 | 616 | 12348/3 | 442 | 12542 | 697 | 12642 | 183 |
| 11700/A | 64 | 11843 | 196 | 11947/443 | 106 | 120X6 | 214 | 12272 | 480 | 12348/4 | 442 | 12543 | 697 | 12643 | 183 |
| 1171/1x6 | 100 | 11844 | 476 | 11947/453 | 106 | 12100 | 38 | 12273 | 480 | 12352 | 442 | 12544 | 697 | 12644/1 | 183 |
| 1171/K | 103 | 11845 | 476 | 11947/455 | 106 | 12101 | 38 | 12274 | 322 | 12353/1 | 357 | 12545 | 697 | 12644/2 | 183 |
| 11724 | 289 | 11846/1x12 | 266 | 11947/509 | 106 | 12102 | 38 | 12275 | 322 | 12353/2 | 357 | 12546 | 697 | 12646 | 192 |
| 11725 | 289 | 11846/2x12 | 266 | 11947/559 | 106 | 12103 | 38 | 12276 | 480 | 12353/3 | 357 | 12547 | 697 | 12647/1 | 192 |
| 11726 | 289 | 11846/3x12 | 266 | 11947/568 | 106 | 12104 | 38 | 12277 | 322 | 12356 | 357 | 12548 | 699 | 12647/2 | 192 |
| 11727 | 289 | 11849 | 454 | 11947/676 | 106 | 12106 | 271 | 12282 | 309 | 12357 | 353 | 12549 | 699 | 12647/3 | 192 |
| 11728 | 289 | 11850 | 176 | 11947/684 | 106 | 12107 | 271 | 12283/01 | 10 | 12358/1 | 652 | 12551 | 697 | 12650 | 192 |
| 11729 | 289 | 11851 | 176 | 11947/690 | 106 | 12110 | 154 | 12283/02 | 10 | 12358/2 | 652 | 12552 | 697 | 12651 | 183 |
| 11737 | 289 | 11852 | 176 | 11947/793 | 106 | 12111 | 43 | 12283/04 | 10 | 1 | | | | | |

| | | | | | | | | | | | | | | | |
|----------|-----|------------|---------|----------|---------|------------|---------|----------|---------|------------|-----|------------|---------|------------|---------|
| 12711/04 | 120 | 12917 | 172 | 1330/C46 | 241 | 1632/U12X3 | 91 | 1761 | 20 | 2120/7X10 | 12 | 2406x12 | 580-700 | 2780/29 | 129 |
| 12711/06 | 120 | 12918 | 159 | 1330/C47 | 241 | 1632/U17X3 | 91 | 1764/25 | 248-318 | 2120/8X10 | 12 | 2408 | 580 | 2780/3 | 129 |
| 12711/09 | 120 | 12919 | 194-437 | 1330/C48 | 241 | 1632/U26X3 | 91 | 1765/25 | 248-318 | 2120/9X10 | 12 | 241 | 314 | 2780/30 | 129 |
| 12711/A6 | 120 | 12920 | 34-159 | 1330/C49 | 241 | 1632/U28X3 | 91 | 1765/3 | 248-318 | 2131 | 82 | 2412 | 282 | 2780/31 | 129 |
| 12717 | 120 | 12921 | 158 | 1330/C50 | 241 | 1633 | 92 | 1766/3 | 248-318 | 2132 | 82 | 2414 | 282 | 2780/43 | 129 |
| 12719 | 694 | 12922 | 158 | 1330/T01 | 241 | 1633/5 | 92 | 1767/1 | 248-318 | 2134/10 | 83 | 245 | 314 | 2780/5 | 129 |
| 12720 | 694 | 12923 | 158 | 1330/T02 | 241 | 1633/U01X3 | 92 | 1767/2 | 248-318 | 2134/11 | 83 | 247 | 314 | 2780/6 | 129-512 |
| 12721 | 694 | 12924 | 159 | 1330/T03 | 241 | 1633/U02X3 | 92 | 1767/3 | 248-318 | 2134/6 | 83 | 249 | 314 | 2780/7 | 129 |
| 12727 | 523 | 12925 | 251 | 1330/T04 | 241 | 1633/U06X3 | 92 | 1767/5 | 248-318 | 2134/7 | 83 | 2490/20 | 324 | 2780/8 | 129 |
| 12728 | 523 | 12926 | 251 | 1330/T09 | 241 | 1633/U07X3 | 92 | 1768 | 248-318 | 2134/8 | 83 | 2490/40 | 324 | 2780/9 | 129 |
| 12730 | 266 | 12927 | 171-251 | 1330/T10 | 241 | 1633/U10X3 | 92 | 1768/5 | 248-318 | 2135/2 | 83 | 2495/20X24 | 317 | 2780/ASS | 129 |
| 12732/12 | 46 | 12928 | 481 | 1330/T11 | 241 | 1633/U12X3 | 92 | 177 | 101 | 2135/3 | 83 | 2495/30X24 | 317 | 2782/1 | 130-512 |
| 12732/24 | 46 | 12929 | 481 | 1330/T12 | 241 | 1633/U21X3 | 92 | 1770/25 | 248-318 | 2135/4 | 83 | 2495/40X24 | 317 | 2782/10 | 130 |
| 12732/96 | 46 | 12930 | 481 | 1330/T17 | 241 | 1633/U25X3 | 92 | 178X10 | 101 | 2135/6 | 83 | 25/2 | 309 | 2782/11 | 130 |
| 12740/12 | 46 | 12931 | 67 | 1330/T18 | 241 | 1633/U26X3 | 92 | 179 | 101 | 2137 | 256 | 254/10 | 135 | 2782/12 | 130 |
| 12740/24 | 46 | 12932 | 473 | 1330/T24 | 241 | 1633/U28X3 | 92 | 1794 | 247-321 | 2138/2 | 257 | 255/24 | 135 | 2782/13 | 130 |
| 12740/48 | 46 | 12933 | 188 | 1330/T25 | 241 | 1634 | 90 | 1795 | 247-321 | 2140 | 258 | 255/BL | 135 | 2782/14 | 130 |
| 12750 | 50 | 12934 | 605 | 1330/T31 | 241 | 1634/5 | 90 | 180/1824 | 95 | 2142 | 257 | 256/35 | 135 | 2782/15 | 130 |
| 12751 | 50 | 12935 | 605 | 1330/T32 | 241 | 1634/U01X3 | 90 | 180/2030 | 95 | 2143 | 258 | 257 | 136 | 2782/16 | 130 |
| 12757/1 | 49 | 12936/1 | 602 | 1330/T33 | 241 | 1634/U02X3 | 90 | 1800 | 247-321 | 2146 | 13 | 258 | 136 | 2782/17 | 130 |
| 12757/2 | 49 | 12936/2 | 602 | 1330/T39 | 241 | 1634/U06X3 | 90 | 1801 | 247-321 | 2148 | 256 | 259 | 136 | 2782/19 | 130 |
| 12757/3 | 49 | 12936/3 | 602 | 1340 | 131-512 | 1634/U10X3 | 90 | 1802 | 247-321 | 2149 | 256 | 262 | 136 | 2782/2 | 130 |
| 12757/A3 | 49 | 12939 | 603 | 1340/1 | 131-512 | 1634/U12X3 | 90 | 183 | 97 | 2150/10 | 31 | 266/120 | 92 | 2782/20 | 130 |
| 12768 | 265 | 12940 | 602 | 1340/2 | 131-512 | 1634/U17X3 | 90 | 184 | 95 | 2151 | 15 | 266/3 | 92 | 2782/3 | 130 |
| 1280 | 262 | 12941 | 603 | 14059 | 616 | 1634/U21X3 | 90 | 185 | 95 | 2154/10/03 | 9 | 266/5 | 92 | 2782/4 | 130 |
| 1281 | 262 | 12942 | 603 | 14060 | 616 | 1634/U25X3 | 90 | 19 | 309 | 2154/10/04 | 9 | 266/7 | 92 | 2782/5 | 130 |
| 1282 | 262 | 12943 | 603 | 14148 | 616 | 1634/U26X3 | 90 | 190 | 97-199 | 2154/10/06 | 9 | 268 | 92 | 2782/8 | 130 |
| 12829 | 273 | 12944 | 624 | 15 | 76 | 1634/U28X3 | 90 | 196 | 96 | 2154/10/08 | 9 | 269 | 126 | 2782/9 | 130 |
| 12830 | 495 | 12945 | 64-107 | 1500 | 228 | 1636/1X5 | 163 | 2001 | 93 | 2154/10/09 | 9 | 270 | 133 | 2782/ASS | 130 |
| 12831 | 495 | 12946 | 362-583 | 1506X6 | 228 | 1636/2X5 | 163 | 201 | 115 | 2154/24 | 9 | 271 | 133 | 2785/1 | 131 |
| 12832 | 496 | 12947 | 362-583 | 1530 | 471 | 1636/3X5 | 163 | 201/1 | 115 | 2155 | 16 | 272 | 121 | 2785/2 | 131 |
| 12833 | 496 | 12948 | 423 | 15310 | 487 | 1637/01 | 65 | 2011 | 93 | 2156 | 16 | 272/25 | 121 | 2785/3 | 131-260 |
| 12834 | 496 | 13/10 | 290 | 15344 | 79 | 1637/02 | 65 | 2020 | 6 | 2157 | 16 | 273 | 124 | 286 | 310 |
| 12835 | 496 | 13/11 | 290 | 15349 | 504 | 1637/06 | 65 | 2022 | 612 | 2160 | 175 | 275 | 121 | 2PK/1 | 288 |
| 12836 | 495 | 13/8 | 290 | 1535 | 469 | 1637/10 | 65 | 203 | 97 | 2161 | 175 | 275/25 | 121 | 2PK/2 | 288 |
| 12837 | 495 | 13/9 | 290 | 1540 | 238 | 1637/12 | 65 | 2034 | 21 | 2162 | 175 | 276 | 126 | 2PK/3 | 288 |
| 12838 | 496 | 130/1/A | 202 | 1550 | 238 | 1637/26 | 65 | 205 | 115 | 2165 | 16 | 276/1000 | 126 | 2PK/ASSX12 | 288 |
| 12839 | 694 | 130/1/B | 202 | 1552 | 238 | 1637/A | 65 | 205/1 | 115 | 2172 | 16 | 278/1 | 128 | 2S/1 | 288 |
| 12840 | 279 | 130/1/F | 202 | 1570 | 176 | 1638 | 86 | 206 | 115 | 2180 | 11 | 278/10 | 128 | 2S/2 | 288 |
| 12859 | 42 | 130/1/I | 202 | 1571 | 176 | 164 | 97 | 206/1 | 115 | 2196/1 | 20 | 278/11 | 128 | 2S/3 | 288 |
| 1286/AZ | 261 | 130/1/O | 202 | 1572/01 | 176 | 1640 | 233 | 2070 | 14 | 2196/2 | 20 | 278/12 | 128 | 2S/ASSX20 | 288 |
| 1286/B | 261 | 130/1/R | 202 | 1572/02 | 176 | 1641 | 164 | 2071 | 14 | 2196/3 | 20 | 278/13 | 128 | 2S/V4X6 | 288 |
| 1286/BL | 261 | 130/1/RA | 202 | 1572/03 | 176 | 1642/1 | 91 | 2073/18 | 127 | 2196/4 | 20 | 278/14 | 128 | 3004x4 | 579-700 |
| 1286/G | 261 | 130/1/T | 202 | 1572/04 | 176 | 1642/2 | 91 | 2081 | 11 | 2196/5 | 20 | 278/15 | 128 | 3005x4 | 579-700 |
| 1286/R | 261 | 130/1/V | 202 | 1572/05 | 176 | 1642/3 | 91 | 210 | 115 | 22 | 309 | 278/16 | 128 | 3006x4 | 579-700 |
| 1286/RS | 261 | 130/1/VE | 202 | 1572/06 | 176 | 1642/4 | 91 | 210051 | 223 | 2200 | 34 | 278/17 | 128 | 3008x4 | 579-700 |
| 1286/V | 261 | 130/1/VI | 202 | 1572/07 | 176 | 165 | 95 | 210221 | 223 | 2205 | 34 | 278/18 | 128 | 3010x4 | 579-700 |
| 12863 | 77 | 130/100/1 | 203 | 1572/08 | 176 | 166 | 95 | 210250 | 223 | 2206/1 | 34 | 278/19 | 128 | 3015x4 | 579-700 |
| 12866 | 652 | 130/100/10 | 203 | 1572/09 | 176 | 1662 | 167 | 210322 | 223 | 2206/10 | 34 | 278/2 | 128 | 3024x4 | 578-700 |
| 12867 | 674 | 130/100/2 | 203 | 1572/10 | 176 | 169 | 96 | 210330 | 223 | 2206/11 | 34 | 278/20 | 128 | 3025x4 | 578-700 |
| 12868 | 676 | 130/100/3 | 203 | 1575/01 | 176 | 1700 | 210 | 210331 | 223 | 2206/12 | 34 | 278/22 | 128 | 3026x4 | 578 |
| 12869 | 676 | 130/100/4 | 203 | 1575/02 | 176 | 17001 | 575 | 210405 | 223 | 2206/13 | 34 | 278/23 | 128 | 3030X4 | 611 |
| 12870 | 676 | 130/100/5 | 203 | 1575/03 | 176 | 1705/E | 189 | 210409 | 223 | 2206/14 | 34 | 278/24 | 128 | 3035X4 | 611 |
| 12871 | 675 | 130/100/6 | 203 | 1575/04 | 176 | 1705/F | 189 | 210445 | 223 | 2206/15 | 34 | 278/25 | 128 | 3040 | 598 |
| 12872 | 675 | 130/100/7 | 203 | 1575/05 | 176 | 1705/G | 189 | 210462 | 223 | 2206/16 | 34 | 278/26 | 128 | 3041 | 598 |
| 12873 | 675 | 130/100/8 | 203 | 1575/06 | 176 | 1705/N | 189 | 210545 | 223 | 2206/2 | 34 | 278/27 | 128 | 3042 | 598 |
| 12874 | 675 | 130/100/9 | 203 | 1575/07 | 176 | 171 | 97 | 210608 | 223 | 2206/3 | 34 | 278/28 | 128 | 3045 | 598 |
| 12875 | 431 | 130/50 | 202 | 1575/08 | 176 | 1712/20 | 439 | 210709 | 223 | 2206/4 | 34 | 278/29 | 128 | 3046 | 598 |
| 12876 | 431 | 130/GL5 | 202 | 1575/09 | 176 | 1715 | 208-591 | 210748 | 223 | 2206/5 | 34 | 278/3 | 128 | 3047 | 598 |
| 12877 | 342 | 1304 | 103 | 1575/10 | 176 | 1716X6 | 192 | 210770 | 223 | 2206/6 | 34 | 278/30 | 128 | 31 | 472 |
| 12878 | 449 | 1306 | 103 | 1581/2 | 290 | 1717/25 | 185 | 2110/1 | 12 | 2206/7 | 34 | 278/31 | 128 | 32 | 472 |
| 12879 | 479 | 13118 | 328 | 1581/3 | 290 | 1718x12 | 185 | 2110/10 | 12 | 2206/8 | 34 | 278/32 | 128 | 32103 | 615 |
| 12880 | 575 | 1312 | 226 | 1582/1X5 | 213 | 1719 | 186 | 2110/11 | 12 | 2206/9 | 34 | 278/33 | 128 | 32121 | 615 |
| 12882 | 87 | 1312/1 | 226 | 1582/2X5 | 213 | 172 | 101 | 2110/12 | 12 | 2208/1 | 34 | 278/34 | 128 | 32122 | 615 |
| 12883 | 77 | 1314X10 | 228-304 | 1582/3X5 | 213 | 172/5 | 101 | 2110/2 | 12 | 2208/2 | 34 | 278/35 | 128 | 32124 | 615 |
| 12884 | 79 | 1315 | 228 | 1583 | 215 | 17200 | 437 | 2110/3 | 12 | 2208/3 | 34 | 278/36 | 128 | 33007 | 401 |
| 12885 | 587 | 1330/C05 | 241 | 1584 | 225-239 | 173/3X5 | 101 | 2110/4 | 12 | 2208/4 | 34 | 278/37 | 128 | 33009 | 504 |
| 12886 | 587 | 1330/C06 | 241 | 1585 | 215 | 1730/01 | 211 | 2110/5 | 12 | 2208/5 | 34 | 278/38 | 128 | 33012 | 400 |
| 12887 | 487 | 1330/C07 | 241 | 1593 | 229 | 1730/02 | 211 | 2110/6 | 12 | 2210 | 34 | 278/39 | 128 | 33015 | 401-460 |
| 12888 | 485 | 1330/C08 | 241 | 1594X6 | 229 | 1730/03 | 211 | 2110/7 | 12 | 2212 | 14 | 278/4 | 128 | 33016 | 401-460 |
| 12889 | 484 | 1330/C13 | 241 | 1595 | 229 | 1730/04 | 211 | 2110/8 | 12 | 2214 | 14 | 278/5 | 128 | 33017 | 401-460 |
| 12890 | 485 | 1330/C14 | 241 | 1596 | 229 | 1730/05 | 211 | 2110/9 | 12 | 2220 | 20 | 278/6 | 128 | 33018 | 401-460 |
| 12891 | 486 | 1330/C15 | 241 | 1597 | 229 | 1730/06 | 211 | 211235 | 223 | 2221 | 20 | 278/7 | 128 | 33022 | 401 |
| 12892 | 482 | 1330/C16 | 241 | 1598 | 228 | 1730/07 | 211 | 211435 | 223 | 2225/1 | 34 | 278/8 | 128 | 33023 | 401-460 |
| 12893 | 478 | 1330/C19 | 241 | 1599/1 | 228 | 1730/08 | 211 | 2115/1 | 13 | 2225/2 | 34 | 278/9 | 128 | 33029 | 405 |
| 12894 | 610 | 1330/C20 | 241 | 1599/2 | 228 | 1730/09 | 211 | 2115/10 | 13 | 2225/3 | 34 | 278/ASS | 128 | 33030 | 405 |
| 12895 | 610 | 1330/C21 | 241 | 1599/3 | 228 | 1730/10 | 211 | 2115/2 | 13 | 2225/4 | 34 | 2780/1 | 129 | 33031 | 405 |
| 12896 | 610 | 1330/C22 | 241 | 1599/4 | 228 | 1730/11 | 211 | 2115/3 | 13 | 2225/A | 34 | 2780/10 | 129 | 33032 | 405 |
| 12897 | 486 | 1330/C23 | 241 | 1599/5 | 228 | 1730/ASS | 211 | 2115/4 | 13 | 2242 | 30 | 2780/11 | 129 | 33033 | 347 |
| 12898 | 486 | 1330/C26 | 241 | 1599/6 | 228 | 1731 | 211 | 2115/5 | | | | | | | |

| | | | | | | | | | | | | | | | |
|-----------|-----|------------|-----|------------|--------|-----------|---------|-----------|---------|------------|---------|------------|---------|---------|---------|
| 354/2535 | 93 | 53/06/3 | 299 | 61/4 | 292 | 706/24 | 11 | 76/5050 | 278 | 816/90X16 | 142 | 932/1 | 236 | BJ376 | 333 |
| 354/3040 | 93 | 53/06/4 | 299 | 61/6 | 292 | 707/K10 | 11 | 762 | 282 | 817 | 148-609 | 932/2 | 236 | BJ377 | 504 |
| 354/3050 | 93 | 53/06/5 | 299 | 61/8 | 292 | 710/10 | 12 | 763 | 282 | 82/5066/1 | 278 | 932/3 | 236 | BJ420 | 85-672 |
| 354/3550 | 93 | 53/06/6 | 299 | 61/9 | 292 | 710/6 | 12 | 763770 | 329 | 82/5066/2 | 278 | 932/4 | 236 | BJ421 | 85-672 |
| 354/4050 | 93 | 53/10/3X30 | 299 | 610/12 | 223 | 713/24/11 | 12 | 767 | 283 | 82/5066/3 | 278 | 940/12 | 191 | BJ422 | 372 |
| 354/5060 | 93 | 53/10/4X30 | 299 | 610/17 | 223 | 713/24/12 | 12 | 768 | 283 | 82/5066/4 | 278 | 940/20 | 191 | BJ423 | 372 |
| 354/5070 | 93 | 53/10/5X30 | 299 | 610/25 | 223 | 713/24/2 | 12 | 77/5066 | 278-324 | 823 | 300 | 940/5 | 191 | BJ424 | 372 |
| 355/1318 | 94 | 53/10/6X30 | 299 | 610/47 | 223 | 713/24/7 | 12 | 770/S | 282 | 823/10 | 300 | 940/7 | 191 | BJ431 | 400 |
| 355/1824 | 94 | 53/15/3X25 | 299 | 610534 | 223 | 713/24/9 | 12 | 772/S | 281 | 823/5 | 300 | 945 | 195 | BJ432 | 400 |
| 355/2020 | 94 | 53/15/4X25 | 299 | 610618 | 223 | 713/30 | 12 | 773 | 283 | 831/1 | 20 | 946 | 195 | BJ433 | 400 |
| 355/2430 | 94 | 53/15/5X25 | 299 | 611829 | 223 | 713/50 | 12 | 775 | 280 | 831/2 | 20 | 947/1 | 195 | BJ434 | 400 |
| 355/2535 | 94 | 53/15/6X25 | 299 | 613 | 296 | 714/24 | 8 | 775/SF | 280 | 831/4 | 20 | 947/10 | 195 | BJ435 | 400 |
| 355/3040 | 94 | 53034 | 384 | 614/1 | 259 | 715/10 | 25 | 777/T1 | 282 | 83102 | 270 | 947/11 | 195 | BJ437 | 497 |
| 355/3070 | 94 | 53942 | 384 | 614/3 | 255 | 715/15 | 25 | 777/T2 | 282 | 840/100 | 304 | 947/12 | 195 | BJ457 | 423-466 |
| 355/3550 | 94 | 54 | 302 | 615/1 | 89-259 | 716/15 | 25 | 777/T3 | 282 | 840/40 | 304 | 947/13 | 195 | BJ459 | 467 |
| 355/4050 | 94 | 54977 | 331 | 615/2 | 89-259 | 716/60 | 25 | 777/T4 | 282 | 840/50 | 304 | 947/14 | 195 | BJ464 | 494 |
| 355/5070 | 94 | 54988 | 331 | 62/2 | 292 | 717/1/01 | 25 | 777/T5 | 282 | 840/60 | 304 | 947/2 | 195 | BJ466 | 501 |
| 355/70100 | 94 | 55/10 | 299 | 62/5 | 292 | 717/1/02 | 25 | 779/1 | 280 | 840/70 | 304 | 947/3 | 195 | BJ467 | 501 |
| 356/1530 | 94 | 550 | 306 | 62/6 | 292 | 717/1/03 | 25 | 78/5066 | 277-278 | 841/50X24 | 304 | 947/4 | 195 | BJ474 | 499 |
| 356/2030 | 94 | 550/1 | 306 | 620 | 310 | 717/1/04 | 25 | 781 | 30 | 841/70X18 | 304 | 947/5 | 195 | BJ475 | 499 |
| 356/2040 | 94 | 551 | 306 | 6203 | 566 | 717/1/05 | 25 | 790/001 | 302 | 842T/100 | 38-304 | 947/6 | 195 | BJ476 | 499 |
| 356/2050 | 94 | 55978 | 368 | 6204 | 566 | 717/1/06 | 25 | 790/002 | 302 | 844X6 | 38-304 | 947/7 | 195 | BJ477 | 499 |
| 356/3040 | 94 | 560 | 306 | 621/300 | 88-126 | 717/1/07 | 25 | 790/003 | 302 | 85 | 279 | 947/8 | 195 | BJ490 | 503-516 |
| 356/3070 | 94 | 561 | 306 | 622 | 88-126 | 717/1/08 | 25 | 790/032 | 302 | 871408 | 3 | 947/9 | 195 | BJ505 | 438 |
| 356/3080 | 94 | 562 | 306 | 6230 | 590 | 717/1/09 | 25 | 790/050 | 302 | 875 | 519 | 948 | 195 | BJ508 | 430 |
| 356/3090 | 94 | 563 | 306 | 6232 | 590 | 717/1/10 | 25 | 790/072 | 302 | 880/120X10 | 139 | 950/2 | 291 | BJ509 | 406 |
| 356/3550 | 94 | 564 | 306 | 6240 | 188 | 717/1/11 | 25 | 790/102 | 302 | 880/60X12 | 139 | 950/3 | 291 | BJ511 | 459 |
| 356/4050 | 94 | 565 | 306 | 6241 | 188 | 717/1/12 | 25 | 790/103 | 302 | 880/80X12 | 139 | 950/4 | 291 | BJ517 | 416 |
| 356/4080 | 94 | 566 | 306 | 625 | 113 | 717/1/13 | 25 | 790/116 | 302 | 881/100X5 | 140 | 9600 | 156 | BJ519 | 409 |
| 356/5060 | 94 | 56683 | 345 | 626 | 113 | 717/1/14 | 25 | 790/120 | 302 | 881/60X5 | 140 | 9605 | 24 | BJ520 | 409 |
| 356/5070 | 94 | 567 | 306 | 627 | 113 | 717/1/15 | 25 | 790/1235 | 302 | 881/80X5 | 140 | 98/MP331/M | 295 | BJ526 | 450 |
| 356/6080 | 94 | 56705 | 449 | 628 | 113 | 717/1/16 | 25 | 790/151 | 302 | 882/110X5 | 140 | B22 | 279 | BJ531 | 454 |
| 356/70100 | 94 | 56716 | 444 | 63 | 292 | 717/15 | 25 | 790/163 | 302 | 882/140X5 | 140 | BA12/1 | 99 | BJ535 | 417 |
| 370/P | 308 | 568 | 306 | 64/1510 | 277 | 717/24 | 25 | 790/172 | 302 | 9/1 | 297 | BA12/2 | 99 | BJ538 | 459 |
| 384/1824 | 93 | 56828 | 342 | 64/1533 | 277 | 717/60 | 25 | 790/182 | 302 | 9/2 | 297 | BB014 | 403 | BJ588 | 420 |
| 384/2030 | 93 | 56869 | 419 | 64/1533/BL | 277 | 718/01 | 25 | 790/193 | 302 | 9/4 | 297 | BB015 | 403 | BJ592 | 450 |
| 384/2535 | 93 | 569 | 306 | 64/1933 | 277 | 718/02 | 25 | 790/206 | 302 | 9/ASSX14 | 297 | BB016 | 403 | BJ601 | 329 |
| 384/3040 | 93 | 56904 | 419 | 64001 | 514 | 718/03 | 25 | 790/246 | 302 | 910 | 250 | BB017 | 403 | BJ617 | 494 |
| 384/4050 | 93 | 570 | 307 | 64002 | 514 | 718/04 | 25 | 790/250 | 302 | 912 | 250 | BB032 | 411 | BJ620 | 494 |
| 385/1824 | 94 | 571 | 307 | 64008 | 514 | 718/05 | 25 | 790/264 | 302 | 913 | 250 | BB037 | 331 | BJ623 | 497 |
| 385/2535 | 94 | 572/15 | 307 | 64019 | 515 | 718/06 | 25 | 790/266 | 302 | 914 | 250 | BB040 | 333 | BJ624 | 497 |
| 385/3040 | 94 | 573 | 307 | 64024 | 515 | 718/07 | 25 | 790/277 | 302 | 915 | 250 | BB054 | 332 | BJ628 | 497 |
| 385/4050 | 94 | 575/24 | 307 | 64025 | 515 | 718/08 | 25 | 790/293 | 302 | 916 | 252 | BB055 | 411 | BJ662 | 437 |
| 385/5070 | 94 | 57546 | 408 | 64027 | 515 | 718/09 | 25 | 790/294 | 302 | 917 | 252 | BB069 | 329 | BJ682 | 377 |
| 387/2 | 250 | 57547 | 408 | 65/100 | 292 | 718/10 | 25 | 790/298 | 302 | 918 | 252 | BB083 | 458 | BJ684 | 378 |
| 387/3 | 250 | 57550 | 409 | 650 | 309 | 718/11 | 25 | 790/324 | 302 | 920 | 252 | BB094 | 333 | BJ688 | 355 |
| 390/4 | 250 | 57593 | 409 | 65000 | 614 | 718/12 | 25 | 790/3282 | 302 | 927/02 | 237 | BB095 | 348 | BJ693 | 504 |
| 390/5 | 250 | 576 | 306 | 651 | 309 | 718/13 | 25 | 790/340 | 302 | 927/03 | 237 | BB096 | 330 | BJ696 | 335 |
| 390/6 | 250 | 57684 | 418 | 65100 | 328 | 718/14 | 25 | 790/344 | 302 | 927/05 | 237 | BB104 | 334 | BJ698 | 422 |
| 390/7 | 250 | 57737 | 467 | 65123x4 | 259 | 718/15 | 25 | 790/348 | 302 | 927/06 | 237 | BB106 | 411 | bJ704 | 517 |
| 390-4/10 | 250 | 57808 | 419 | 652 | 309 | 718/16 | 25 | 790/361 | 302 | 927/07 | 237 | BB107 | 336 | bJ705 | 517 |
| 390-5/10 | 250 | 57866 | 408 | 653 | 309 | 718/60 | 25 | 790/381 | 302 | 927/08 | 237 | BB108 | 330 | BJ741 | 420 |
| 390-6/10 | 250 | 57874 | 408 | 66/1566 | 277 | 72300 | 610 | 790/413 | 302 | 927/09 | 237 | BB109 | 334 | BJ742 | 420 |
| 390-7/10 | 250 | 57891 | 419 | 66/1566/BL | 277 | 727/2 | 238-304 | 790/424 | 302 | 927/10 | 237 | BB111 | 331 | BJ747 | 499 |
| 40 | 114 | 57892 | 419 | 66/1966 | 277 | 727/3 | 238-304 | 790/427 | 302 | 927/11 | 237 | BB115 | 332 | BJ748 | 499 |
| 407/P | 308 | 57897 | 405 | 66000 | 614 | 728X10 | 27 | 790/432 | 302 | 927/12 | 237 | BB125 | 334 | BJ755 | 411 |
| 444/P | 308 | 57907 | 409 | 665 | 309 | 729X10 | 27 | 790/442 | 302 | 927/13 | 237 | BB144 | 337 | BJ756 | 411 |
| 45 | 114 | 57929 | 409 | 666 | 309 | 73/BL | 289 | 790/443 | 302 | 927/14 | 237 | BB301 | 470 | BJ757 | 411 |
| 480/P | 308 | 57961 | 336 | 673 | 309 | 73/NE | 289 | 790/4625 | 302 | 927/16 | 237 | BB512 | 328 | BJ766 | 407 |
| 481 | 308 | 57996 | 409 | 67820 | 255 | 73/RO | 289 | 790/469 | 302 | 927/17 | 237 | BJ001 | 413 | BJ776 | 617 |
| 499X12 | 269 | 581 | 306 | 67835 | 255 | 730X5 | 215 | 790/471 | 302 | 927/18 | 237 | BJ003 | 381-406 | BJ782 | 407 |
| 50/1 | 299 | 584/25 | 306 | 67893 | 255 | 73183x25 | 255 | 80/1933 | 277 | 927/19 | 237 | BJ011 | 407 | BJ791 | 448 |
| 50/2 | 299 | 584/30 | 306 | 68/2 | 292 | 732370 | 328 | 81/1950 | 277 | 927/20 | 237 | BJ026 | 403 | BJ797 | 368 |
| 50/3 | 299 | 584/35 | 306 | 68538 | 513 | 733/12 | 9 | 81/2550 | 277 | 928/01 | 237 | BJ029 | 416 | BJ798 | 417 |
| 50/4 | 299 | 58494 | 153 | 68539 | 513 | 733840 | 328 | 81/3850 | 277 | 928/02 | 237 | BJ036 | 343-404 | BJ816 | 402 |
| 50/5 | 299 | 585 | 306 | 70/ASSX6 | 288 | 737/2X10 | 31 | 81/5050 | 277 | 928/03 | 237 | BJ037 | 343-404 | BJ817 | 402 |
| 50/6 | 299 | 58577 | 336 | 70/BL | 288 | 737/3X10 | 31 | 810/A | 16 | 928/04 | 237 | BJ038 | 343-404 | BJ908 | 413 |
| 50/8/ASS | 299 | 58578 | 470 | 70/NE | 288 | 737/4X10 | 31 | 810/O | 16 | 928/05 | 237 | BJ090 | 415-430 | BJ909 | 413 |
| 50/8B | 299 | 58580 | 330 | 70/RO | 288 | 737/5X10 | 31 | 810/R | 16 | 928/06 | 237 | BJ091 | 415-430 | BJ910 | 413 |
| 50/8N | 299 | 58626 | 459 | 700/10 | 12 | 74/R | 288 | 812 | 148-609 | 928/07 | 237 | BJ098 | 427 | BJ917 | 418 |
| 5001 | 300 | 58649 | 469 | 700/12 | 8 | 740 | 17 | 815/10X3 | 144 | 928/08 | 237 | BJ144 | 466 | BJ943 | 494 |
| 5001/ASS | 300 | 58669 | 348 | 700/20 | 9 | 74015x24 | 255-513 | 815/11X3 | 144 | 928/09 | 237 | BJ161 | 462 | BJD016 | 507 |
| 50400 | 369 | 58864 | 330 | 700/6 | 9 | 74020x24 | 255-513 | 815/12X15 | 142 | 928/10 | 237 | BJ162 | 462 | BJD509 | 507 |
| 51/2B | 302 | 58893 | 336 | 700/7 | 13 | 741 | 17 | 815/13X22 | 142 | 928/11 | 237 | BJ210 | 466 | BJD526 | 507 |
| 51/A | 302 | 58908 | 437 | 701/12 | 8 | 742 | 17 | 815/14X4 | 143 | 928/12 | 237 | BJ225 | 407 | BJE0002 | 450 |
| 51/B | 302 | 58950 | 311 | 701/6 | 9 | 743 | 17 | 815/15X4 | 144 | 928/13 | 237 | BJ226 | 402 | BJE0004 | 450 |
| 51/R | 302 | 58952 | 311 | 701/7 | 13 | 744 | 17 | 815/16X4 | 143 | 929/1 | 234 | BJ229 | 467 | BJE0016 | 450 |
| 51/V | 302 | 58980 | 450 | 702/12 | 13 | 745 | 17 | 815/17X5 | 143 | 929/2 | 234 | BJ246 | 467 | BJE0023 | 487 |
| 511/20 | 307 | 58988 | 193 | 703/24/1 | 8 | 746 | 15 | 815/18X8 | 143-148 | 930M/03 | 236 | BJ255 | 336 | BJE0026 | 450 |
| 51557 | 381 | 590 | 307 | 703/24/10 | 8 | 748 | 15 | 815/1X15 | 143 | 930M/04 | 236 | BJ256 | 336 | BJE0170 | 487 |
| 51786 | 517 | 59009 | 342 | 703/24/11 | 8 | 74800 | 616 | 815/20X8 | 143 | 930M/05 | 236 | BJ257 | 408 | BJT010 | 363 |
| 51805 | 505 | 591 | | | | | | | | | | | | | |

| | | | | | | | | | | | |
|------------|---------|--------------|---------|-----------|--------|-----------|---------|-------------|-----|-------|-----|
| BJT120 | 367 | D330/U25X3 | 90 | KR970854 | 305 | MY/MOP48 | 58 | T0407 | 503 | WM034 | 333 |
| BJT136 | 367 | D330/U26X3 | 90 | KR970858 | 305 | MY/MT1000 | 122 | T05 | 284 | WT228 | 285 |
| BJT139 | 367 | D330/U28X3 | 90 | KR970999 | 271 | MY/MW1000 | 122 | T0801 | 271 | WT23 | 285 |
| BJT140 | 371 | D330/U30X3 | 109 | KR971083 | 307 | MY/R100 | 60 | T093 | 272 | WTL6 | 285 |
| BJT141 | 371 | D330/U31X3 | 109 | KR971105 | 305 | MY/W100 | 60 | T105 | 274 | WTL8 | 285 |
| BJT180 | 368 | DV7425 | 526 | KR971172 | 307 | OT004 | 393 | T107 | 659 | X066 | 458 |
| BJT200 | 369 | E1013 | 286 | KR971236 | 305 | OT006 | 391 | T108 | 658 | | |
| BJT247 | 367 | E1030 | 286 | KR971247 | 305 | OT018 | 390 | T109 | 660 | | |
| BJT272 | 365 | E1099 | 285 | KR971313 | 305 | OT019 | 391 | T113 | 276 | | |
| BJT421 | 368 | E1336 | 104 | KR971406 | 281 | OT020 | 394 | T1134 | 464 | | |
| BJT461 | 368 | E1338 | 104 | KR971429 | 305 | OT026 | 390 | T114 | 276 | | |
| C111002 | 61 | E1386 | 110 | KR971442 | 303 | OT044 | 395 | T1140 | 269 | | |
| C112008 | 61 | E707 | 285 | KR971505 | 280 | OT051 | 390 | T1211 | 293 | | |
| C1380/12 | 54-267 | E803 | 294 | KR971532 | 280 | OT060 | 394 | T200 | 287 | | |
| C1380/60 | 54-267 | E818 | 109 | KR971533 | 303 | OT062 | 395 | T221 | 103 | | |
| C1602/12 | 54-267 | E828 | 286 | KR971539 | 54-267 | OT069 | 393 | T278 | 135 | | |
| C1602/60 | 54-267 | E898 | 279 | KR971540 | 54-267 | OT070 | 392 | T28 | 290 | | |
| C1623 | 104 | E898/4 | 279 | KR971551 | 280 | OT071 | 395 | T320 | 317 | | |
| C1770/2B | 54-267 | E9201 | 285 | KR971552 | 280 | OT094 | 391 | T402/2X144 | 293 | | |
| C1770/B | 54-267 | EF0047 | 245 | KR971605 | 270 | OT096 | 392 | T402/3X144 | 293 | | |
| C1770/E | 54-267 | F102X20 | 362-583 | KR971606 | 270 | OT097 | 396 | T402/4X12 | 293 | | |
| C1770/F | 54-267 | FM827/1 | 566 | KR971783 | 270 | OT100 | 396 | T402/5X12 | 293 | | |
| C1770/H | 54-267 | FM967C | 169 | KR971813 | 271 | OT201 | 396 | T403/2.5X12 | 293 | | |
| C1770/HB | 54-267 | GW45311 | 613 | KR971814 | 271 | OT202 | 402 | T403/2X144 | 293 | | |
| C213 | 295 | GW45333 | 613 | KR971833 | 280 | OT203 | 397 | T403/3X12 | 293 | | |
| C214 | 295 | GW45411 | 495 | KR971835 | 269 | OT204 | 421 | T403/4X12 | 293 | | |
| C2635 | 266 | GW45437 | 496 | KR971844 | 280 | OT210 | 396 | T470 | 135 | | |
| c265 | 119 | H6521/40 | 271 | KR971845 | 303 | OT213 | 421 | T48 | 290 | | |
| C2670/1 | 264 | HS129 | 451 | KR971857 | 72 | OT220 | 389 | T510 | 271 | | |
| C2670/2 | 264 | HS530 | 451 | KR971869 | 52 | OT221 | 389 | T512/100X12 | 75 | | |
| C2690/1 | 264 | HS973 | 451 | KR971870 | 52 | OT223 | 398 | T512/25X12 | 75 | | |
| C2690/2 | 264 | J401 | 352 | KR971871 | 52 | OT224 | 398 | T512/50X12 | 75 | | |
| C2690/BL2 | 264 | JP101/N01X12 | 71 | KR972059 | 281 | OT225 | 397 | T512/75X12 | 75 | | |
| C2739/10 | 48 | JP101/N02X12 | 71 | KR972060 | 281 | OT231 | 389 | T564A | 272 | | |
| C2739/6 | 48 | JP101/N03X12 | 71 | KR972102 | 52 | OT256 | 398 | T705A | 273 | | |
| C3423/12 | 53-267 | JP101/N04X12 | 71 | KR972116 | 269 | OT290 | 397 | T705A/1000 | 273 | | |
| C3616/60 | 51 | JP101/N05X12 | 71 | KR972117 | 269 | OT510 | 394 | T705M | 273 | | |
| C3616H/12 | 53 | JP101/N06X12 | 71 | KR972314 | 51 | OTCB01 | 399-524 | T705W | 273 | | |
| C3616N/60 | 53 | JP101/N07X12 | 71 | KR972315 | 74 | OTCB02 | 399-524 | T72 | 290 | | |
| C3652 | 51 | JP101/N08X12 | 71 | KR972316 | 74 | OTCB03 | 399-524 | T7420 | 290 | | |
| C4010 | 53 | JP101/N09X12 | 71 | KR972317 | 281 | OTCB04 | 399-524 | T760 | 283 | | |
| C4150/1 | 268 | JP101/N10X12 | 71 | KR972319 | 47 | OTCB08 | 399-524 | T8416 | 290 | | |
| C4150/2 | 268 | JP101/N11X12 | 71 | KR972320 | 47 | OTCB09 | 399-524 | T868 | 290 | | |
| C4150/3 | 268 | JP101/N12X12 | 71 | KR972321 | 47 | OTCB10 | 399-524 | TAC50 | 307 | | |
| C4150/4 | 268 | JT113 | 383 | KR972322 | 57 | OTCB11 | 399-524 | TCM002 | 287 | | |
| C4150/5 | 268 | JT116 | 380 | KR972323 | 67 | OTCB12 | 399-524 | TCM004 | 287 | | |
| C417 | 286 | JT117 | 379-387 | KR972324 | 66 | PF100 | 434 | TCM008 | 287 | | |
| C440/16 | 207-293 | JT118 | 382-387 | KR972325 | 61 | PF550/01 | 63 | TCM016 | 287 | | |
| C440/20 | 207-293 | JT123 | 379 | KR972326 | 74 | PF550/02 | 63 | TG02M | 273 | | |
| C440/25 | 207-293 | JT151 | 386 | KR972327 | 86 | PF550/06 | 63 | TH/007 | 228 | | |
| C440/31 | 207-293 | JT152 | 378 | KR972328 | 56 | PF550/07 | 63 | TS501 | 269 | | |
| C440/40 | 207-293 | JT153 | 370 | KR972329 | 70 | PF550/10 | 63 | TT101 | 184 | | |
| C440/50 | 207-293 | JT156 | 377 | KR972330 | 66 | PF550/12 | 63 | TY102 | 273 | | |
| C461/1 | 294 | JT160 | 387 | KR972331 | 57 | PF550/14 | 63 | UR1215 | 35 | | |
| C461/2 | 294 | JT161 | 382-387 | KR972334 | 281 | PF550/17 | 63 | UR1282 | 31 | | |
| C461/3 | 294 | JT162 | 382-387 | KR972337 | 281 | PF550/21 | 63 | UR1291 | 32 | | |
| C461/4 | 294 | K141722 | 112 | KR972338 | 56 | PF550/25 | 63 | UR1405 | 21 | | |
| C461/5 | 294 | K141730 | 112 | KR972339 | 275 | PF550/26 | 63 | UR1520 | 31 | | |
| C461/6 | 294 | K2139N | 53 | KR972346 | 66 | PF550/28 | 63 | UR1521 | 15 | | |
| C461/7 | 294 | K2140N | 53 | KR972347 | 48 | PF550/29 | 63 | UR289 | 14 | | |
| C4865/2B | 268 | K2141N | 53 | KR972348 | 67 | PF550/30 | 63 | UR291 | 14 | | |
| C4865/4B | 268 | K555/25X12 | 72-224 | KR972349 | 74 | PF550/40 | 63 | VIA21/1 | 39 | | |
| C4865/6B | 268 | K555/38X12 | 72-224 | KR972350 | 48 | PF550/41 | 63 | VIA21/11 | 39 | | |
| C5209 | 268 | K555/50X12 | 72-224 | L2M | 70 | PF550/A | 63 | VIA21/12 | 39 | | |
| C5347 | 268 | K555/63X12 | 72-224 | L824 | 70 | PN200 | 563 | VIA21/13 | 39 | | |
| C577/60 | 306 | K577/00X12 | 71 | L94621 | 69 | PR0100 | 245 | VIA21/14 | 39 | | |
| C644 | 285 | K577/02X12 | 71 | M955/6x6 | 291 | PR0209 | 245 | VIA21/15 | 39 | | |
| C7936/M4 | 264 | K577/04X12 | 71 | M955X100 | 291 | PR0211 | 245 | VIA21/16 | 39 | | |
| C7936/MN | 264 | K577/06X12 | 71 | MCW1002 | 434 | PR0212 | 245 | VIA21/17 | 39 | | |
| C7937/F4 | 264 | K577/08X12 | 71 | MP15 | 286 | PR0508 | 245 | VIA21/18 | 39 | | |
| C7937/FN | 264 | K577/10X12 | 71 | MP16 | 286 | R11697 | 182 | VIA21/19 | 39 | | |
| C8772 | 111-264 | K577/12X12 | 71 | MP331/1 | 295 | R164 | 406 | VIA21/2 | 39 | | |
| C8860/R | 265 | K577/14X12 | 71 | MP331/2 | 295 | R165 | 406 | VIA21/20 | 39 | | |
| C8911/2B | 53-268 | K577/16X12 | 71 | MP331/3 | 295 | R21610 | 501 | VIA21/21 | 39 | | |
| C8911/HB | 53-268 | K577/BL5 | 71 | MP331/4 | 295 | R67675 | 628 | VIA21/22 | 39 | | |
| C8938/B4 | 264 | K6421X4 | 271 | MP331/5 | 295 | RA201 | 500 | VIA21/23 | 39 | | |
| C8938/BN | 264 | K766/00X12 | 71 | MP331/6 | 295 | SA059 | 597 | VIA21/24 | 39 | | |
| C90065 | 69 | K766/02X12 | 71 | MP331/7 | 295 | SB301 | 153 | VIA21/25 | 39 | | |
| C9401 | 303 | K766/04X12 | 71 | MP331/8 | 295 | SH7000 | 456 | VIA21/26 | 39 | | |
| C9407 | 303 | K766/06X12 | 71 | MP331/A | 295 | SI3000GR | 329-617 | VIA21/27 | 39 | | |
| CK/90 | 293 | K766/08X12 | 71 | MP331/M | 295 | T0023 | 343-404 | VIA21/3 | 39 | | |
| CK1597 | 308 | K766/10X12 | 71 | MP900 | 295 | T0025 | 343-404 | VIA21/4 | 39 | | |
| CK1600 | 308 | K766/12X12 | 71 | MU131293 | 3 | T0062 | 355 | VIA21/5 | 39 | | |
| D103-6 | 271 | K766/14X12 | 71 | MU131294 | 3 | T0094 | 384 | VIA21/6 | 39 | | |
| D330/5 | 109 | K766/16X12 | 71 | MU131295 | 3 | T0095 | 378-387 | VIA21/7 | 39 | | |
| D330/A | 90 | K766/BL5 | 71 | MU133393 | 3 | T0104 | 498 | VIA21/8 | 39 | | |
| D330/U01X3 | 90 | K867301 | 268 | MU133394 | 3 | T0117 | 377-387 | VIA21/9 | 39 | | |
| D330/U02X3 | 90 | K867302 | 268 | MY/CA100 | 60 | T0125 | 379-387 | VK1060/4 | 374 | | |
| D330/U06X3 | 90 | K867303 | 268 | MY/MCP12 | 61 | T0143 | 378 | VK1084/4 | 373 | | |
| D330/U07X3 | 90 | KD1015 | 185 | MY/MCP24 | 61 | T0145 | 505 | VK1101 | 424 | | |
| D330/U10X3 | 90 | KD1029 | 185 | MY/MCP48 | 61 | T02 | 284 | VL112 | 41 | | |
| D330/U12X3 | 90 | KD1031 | 185 | MY/MOP12 | 58 | T0212 | 505 | W12 | 269 | | |
| D330/U14X3 | 90 | KD2019 | 182 | MY/MOP12S | 58 | T0213 | 505 | W13X20 | 269 | | |
| D330/U17X3 | 90 | KR970531 | 269 | MY/MOP24 | 58 | T0214 | 293-317 | W32 | 269 | | |
| D330/U21X3 | 90 | KR970702 | 271 | MY/MOP24S | 58 | T0217 | 505 | WB505 | 383 | | |

Condizioni di fornitura

Questo catalogo annulla e sostituisce i precedenti e ha validità fino alla pubblicazione della successiva edizione.

- I prezzi indicati annullano e sostituiscono i precedenti e possono essere soggetti a variazioni senza preavviso nel corso dell'anno, dovute a cambi valuta, oscillazione del costo delle materie prime, variazioni dei costi di trasporto, ecc...
- Non si accettano resi di merce se non autorizzati dalla nostra ditta.
- Al ricevimento della merce controllare il numero e l'integrità dei colli.
Se si riscontrano, al momento della ricezione della merce, mancanze o danni è necessario segnalarlo sulla bolla del trasportatore accettando il materiale consegnato e firmando la bolla "con riserva", specificando il danno visibile e dandone comunicazione scritta alla nostra ditta entro 8 giorni dalla data di ricevimento della merce. I danni o gli ammanchi non segnalati sulla bolla e non comunicati per iscritto alla nostra ditta non potranno essere riconosciuti.
- Il collaudo dei materiali dovrà essere effettuato entro 5 giorni dalla data di ricevimento, inviando una copia del verbale alla nostra ditta. Se ciò non avvenisse il collaudo è da ritenersi positivo.
- Non è previsto alcun intervento della ditta per il montaggio o per la posa in opera del materiale acquistato, salvo diversi accordi tra le parti.
- Le illustrazioni presentate non sono vincolanti per la nostra società.
Ci riserviamo il diritto di modificare senza preavviso le peculiarità degli articoli in catalogo, in funzione della costante evoluzione ed aggiornamento.
- Abbiamo lavorato con la massima cura nella realizzazione di questo catalogo, tuttavia la nostra ditta non si assume responsabilità per eventuali errori di stampa o refusi.
- Chiunque utilizzi e/o riproduca anche parzialmente il contenuto del presente catalogo compie un atto sanzionabile ai sensi dell'articolo 2598 c.p.c.
- Alcuni articoli voluminosi viaggiano smontati. In questo caso le istruzioni per il montaggio, ove necessario, sono incluse nella confezione.
- A causa dei recenti avvenimenti che stanno condizionando il panorama mondiale i prezzi presenti in questo catalogo potrebbero subire variazioni senza preavviso. Sarà nostra cura contenere eventuali aumenti il più possibile.
- Scansionare il QR code per avere un listino costantemente aggiornato e il relativo modulo d'ordine.

COMPILAZIONE ORDINI - DATI GENERALI

Per una veloce e corretta evasione degli ordini si prega di indicare quanto segue:

- Dati completi dell'ordinante
- Luogo di consegna (se diverso da quello dell'ordinante).

COMPILAZIONE ORDINI - CODIFICA ARTICOLI

- Onde evitare errori, raccomandiamo di indicare in modo preciso e chiaro i codici articolo, comprensivi di eventuali varianti colore o modello e dello zero iniziale, ove presente.



SCUOLA BUS®